

# Thermo Scientific ThermoFlex™ Recirculating Chillers (Basic Controller)

Thermo Scientific Manual P/N U00933

Rev. 05/20/2015



## Multilingual Quick Start Guides

### Installation

### Operation

### Basic Maintenance

Visit our Web site at:

<http://www.thermoscientific.com/tc>  
Product Service Information, Applications  
Notes, MSDS Forms, e-mail.

Voice Info: (800) 258-0830



# Thermo Scientific ThermoFlex™ Recirculating Chillers (Basic Controller)

Thermo Scientific Manual P/N U00933  
Rev. 05/20/2015



## Multilingual Quick Start Guides

## Installation

## Operation

## Basic Maintenance

Label 1

---

Label 2

---

Visit our Web site at:

<http://www.thermoscientific.com/tc>  
Product Service Information, Applications  
Notes, MSDS Forms, e-mail.

Voice Info: (800) 258-0830

## Thermo Fisher Scientific

25 Nimble Hill Road  
Newington, NH 03801  
Tel : (800) 258-0830 or  
(603) 436-9444  
Fax : (603) 436-8411  
[www.thermoscientific.com/tc](http://www.thermoscientific.com/tc)

## Sales, Service, and Customer Support

25 Nimble Hill Road  
Newington, NH 03801  
Tel: (800) 258-0830  
Sales: 8:00 am to 5:00 pm  
Service and Support: 8:00 am to 6:00 pm Monday  
through Friday (Eastern Time)  
Fax: (603) 436-8411  
[service.tc.us@thermofisher.com](mailto:service.tc.us@thermofisher.com)

Dieselstrasse 4  
D-76227 Karlsruhe, Germany  
Tel : +49 (0) 721 4094 444  
Fax : +49 (0) 721 4094 300  
[info.tc.de@thermofisher.com](mailto:info.tc.de@thermofisher.com)

Building 6, No. 27  
Xin Jinqiao Rd., Shanghai 201206  
Tel : +86(21) 68654588  
Fax : +86(21) 64457830  
[info.china@thermofisher.com](mailto:info.china@thermofisher.com)

### Statement of Copyright

Copyright © 2015 Thermo Fisher Scientific. All rights reserved.

This manual is copyrighted by Thermo Fisher Scientific.

Users are forbidden to reproduce, republish, redistribute, or resell any materials from this manual in either machine-readable form or any other form.

# Contents

## Quick Start

<b>Preface</b> .....	<b>i</b>
Compliance .....	i
WEEE .....	i
After-Sale Support .....	ii
Unpacking .....	ii
Warranty .....	ii
Feedback.....	ii
<b>Section 1 Safety</b> .....	<b>1-1</b>
Warnings.....	1-1
<b>Section 2 General Information</b> .....	<b>2-1</b>
Description .....	2-1
Specifications .....	2-1
<b>Section 3 Installation</b> .....	<b>3-1</b>
Site Requirements .....	3-1
Electrical Requirements .....	3-2
Hard Wire Installation.....	3-8
Plumbing Requirements.....	3-9
Process Fluid Requirements.....	3-11
Compatibility with Approved Fluids .....	3-12
Additional Fluid Information .....	3-14
Process Water Quality and Standards .....	3-14
Facility Water Quality - Standards and Recommendations .....	3-15
Facility Water Requirements.....	3-17
Fluid Filter Bag.....	3-18
Priming.....	3-18
Initial Filling .....	3-18
Fluid Top Off .....	3-20
<b>Section 4 Operation</b> .....	<b>4-1</b>
Basic Controller.....	4-1
Setup .....	4-2
Start Up .....	4-2
Controller Loops.....	4-4
Setpoint Loop.....	4-5
Setup Loop.....	4-6
Shut Down.....	4-12

<b>Section 5</b>	<b>Additional Options/Accessories .....</b>	<b>5-1</b>
	Auto Refill .....	5-1
	Internal DI Cartridge .....	5-2
	P1 P2 T1 Pump Pressure Relief Valve (Internal Configuration).....	5-3
	P1 P2 T1 Pump Pressure Relief Valve (External Configuration) .....	5-4
	Flow Control with Flow Readout.....	5-5
	P1 P2 T1 Pump Pressure Relief with Flow Readout .....	5-5
	T5 Pump Flow Control.....	5-6
	Anti Drainback.....	5-6
	SEMI.....	5-6
	Other Accessories.....	5-10
<b>Section 6</b>	<b>Preventive Maintenance.....</b>	<b>6-1</b>
	Preventive Maintenance Timer .....	6-1
	Fluid Bag Filter.....	6-2
	Fluid Diffuser .....	6-2
	Reservoir Cleaning.....	6-3
	Fluid Maintenance .....	6-3
	Condenser Filter.....	6-4
	Chiller Surface .....	6-5
	Hoses .....	6-5
	DI Filter (Optional) .....	6-6
	Diagnostic Loop .....	6-7
	Testing the Alarm Features .....	6-8
<b>Section 7</b>	<b>Troubleshooting .....</b>	<b>7-1</b>
	Operational Error Codes.....	7-1
	Checklist.....	7-10
	Verifying/Adjusting the Controller PID Values .....	7-13
<b>Section 8</b>	<b>Additional Information .....</b>	<b>8-1</b>
	Draining.....	8-1
	Wetted Materials.....	8-3
	Internal Process Fluid Temperature Sensor (rdt1) Calibration.....	8-4
	Process Fluid Pressure (P1) Transducer Calibration .....	8-6
	Optional Process Fluid Flow (FLo) Transducer Calibration .....	8-8
	Clearing SEr1 Message.....	8-10
	Decommissioning/Disposal .....	8-11
	Shipment/Storage.....	8-11

**Appendix A** Country Specific 230 VAC, 50 Hz, 1 Ø Requirements

**Appendix B** Voltage Configuration Instructions

**Appendix C** Analog I/O and Remote Sensor

**Appendix D** Serial Communications

**Declaration of Conformity**

**WARRANTY**



**This quick start guide is intended for initial start up only. For all other procedures you must refer to the manual. Also, if any of these steps are not clear download the manual before proceeding.**

**Safety:**

- The chiller is designed for indoor use only. Never place the chiller in a location where excessive heat, moisture, inadequate ventilation, or corrosive materials are present.
- Connect the chiller to a properly grounded outlet.
- Refrigerants used are heavier than air and will replace the oxygen causing loss of consciousness. Contact with leaking refrigerant will cause skin burns. Refer to the chiller's nameplate and the manufacturer's most current MSDS for additional information.
- Move the chiller with care. Sudden jolts or drops can damage its components. Always turn the equipment off and disconnect it from its supply voltage before moving it.

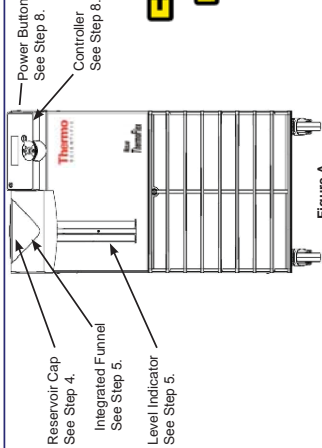

Figure A

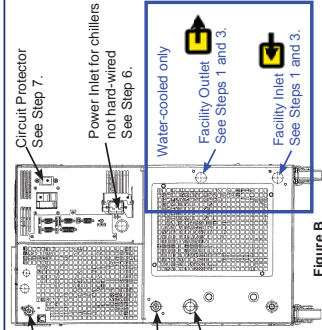

Figure B

**What you need to get started:**

- An adjustable wrench
- Facility water supply and return (water-cooled chillers)
- Appropriate hose or plumbing
- Appropriate size clamps or connection type
- Teflon® Taps or appropriate sealant

**Process Fluid Connections (FNPT)**

Outlet	ThermoFlex900 - 10000	P 1 P 2 T O T 1	1/2" cast bronze
	ThermoFlex3500 - 5000	P 3 P 4	3/4" cast bronze
	ThermoFlex7500 - 24000	P 3 P 5 T 5	1" wrought copper
Inlet - Same size as outlet			all chillers stainless steel

**Supplied Adapters**

P 1 P 2 T O T 1	1/2" x 3/8" Polyethylene and 1/2" x 1/2" Nylon
P 3 P 4	3/4 MPT x 1/2 barb PVC
P 3 P 5 T 5	1" MPT x 1" barb PVC and 1" MPT x 3/4" barb PVC

<b>Table 1 - Approved Fluids:</b>
Use of any other fluid will void the manufacturer's warranty.
Filtered/single distilled water (pH 7-8)
Deionized water (1-3 MΩ-cm, compensated)
Distilled water with Chloro biocide and inhibitor
Distilled water with Nalco biocide (5 ppm)
0 - 75% Laboratory Grade Ethylene Glycol/Water
0 - 75% Laboratory Grade Propylene Glycol/Water

1 Remove all the plastic shipping plugs (2 or 4).

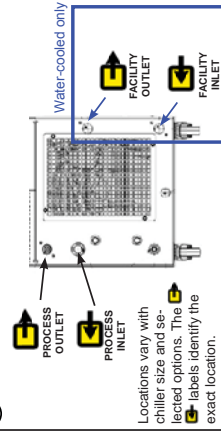

See Figure B.

5 If equipped, place the optional GFCI breaker located on the rear to the up position. For ThermoFlex900 through 10000 chillers, place the circuit protector to the on (I) position. The controller display will indicate a series of scrolling bars (≡). The bars will scroll upward indicating the chiller is initializing, this takes approximately 15 seconds. For other chillers the bars appear when power is supplied to the chiller.

The circuit protector is not intended to act as a disconnecting means.

See Figure B.

2 Connect the ThermoFlex PROCESS OUTLET (A) to the fluid inlet on your application. Connect the ThermoFlex PROCESS INLET (B) to the fluid outlet on your application. Ensure the connections are sealed and secure. For air-cooled chillers skip to Step 4.



Never connect process fluid lines to your facility water supply or to any pressurized liquid source.

See Figure B.

6 Never operate the chiller without process fluid in the reservoir or without the fluid filter bag installed.

Gently pull up on the plastic funnel housing to remove it and install the supplied filter bag. Reinstall the housing.

Remove the reservoir cap from the housing by unscrewing it counterclockwise.

See Figure A.

3 Connect the ThermoFlex FACILITY OUTLET (A) to a facility water return or drain. Connect the ThermoFlex FACILITY INLET (B) to a facility water supply. Ensure the connections are sealed and secure.

For water-cooled only.

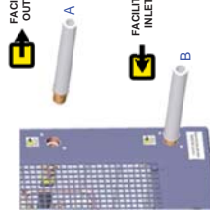

Facility Water Maximum Inlet Pressure must not exceed 150 PSIG. Facility Water Maximum Pressure Differential must not exceed 50 PSID.

See Figure B.

7 Slowly fill reservoir with clean process fluid (see Table 1), utilizing sight tube for easy fluid level monitoring. When the reservoir is full re- place the reservoir cap, hand tight. Since the reservoir capacity may be small compared to your application and air may need to be purged from the lines, have extra fluid on hand to keep the system topped off when external circulation is started. If the fluid level drops too low the chiller will shut down to prevent the pump from running dry. Acknowledge the alarm and re-start the priming process.

Note: Be careful not to fill the reservoir above MAX LEVEL fill line. This will result in a unit over flow error (O FLO) which will cause the chiller to shut down.



See Figure A.

4 Refer to the name plate on the rear of the chiller and verify the appropriate voltage. For chillers supplied with a line cord, insert female end of line cord into chiller and then insert male end of line cord into power outlet. (The line cord is located under the shipping crate's lid. Do not discard the lid until the cord is located.)

Never operate the chiller with a damaged line cord. Note: ThermoFlex900-5000 chillers equipped with the Variable Voltage or Global Voltage option have a voltage configuration panel. Refer to the Voltage Instruction Sheet shipped with the chiller, or see manual/Appendix B.

Note: For chillers requiring hard wiring see Section 3 in the manual.

See Figure B.

8 Press

The controller will display SEtUp.

Note: If the chiller is equipped with a deionization filter cartridge refer to the manual, Section 5, for installation.

Please see reverse side for additional steps.



See Figure A.

**Quick Start - Used for Initial Start Up Only — perform steps 9 to 20 for all units.**

<p><b>NOTE:</b> Some ranges/defaults are pump dependent, see Section 4 in the manual. Once any Setup step is completed, meaning you pressed the <b>enter</b> key a second time, you can not repeat the step to make corrections. You can make changes after the unit is started.</p> <p><b>SETUP</b></p> <ul style="list-style-type: none"> <li>Press <b>enter</b> to continue the setup procedure.</li> </ul>	<p><b>9</b> <b>Units</b> are the temperature, fluid flow (optional) and pressure scales.</p> <p><b>Units:</b> °C/F    <b>GPM/LPM</b> <b>PSI/Bar/KPAS</b></p> <ul style="list-style-type: none"> <li>Press <b>enter</b></li> <li>The display will flash between <b>Units</b> and °C</li> <li>If desired, use <b>←</b> to change the scale to °F</li> <li>Press <b>enter</b> to sequence to the next display</li> <li>Do the same for Flow and Pressure scales</li> </ul>	<p><b>10</b> <b>Hi t</b> sets the fluid's High Temperature Alarm Limit.</p> <p><b>Range:</b> +3°C to +42°C <b>Factory Default:</b> +42°C</p> <ul style="list-style-type: none"> <li>Press <b>enter</b></li> <li>The display will flash between <b>Hi t</b> and <b>42</b></li> <li>If desired, use <b>←</b> to adjust the value</li> <li>Press <b>enter</b> to sequence to the next display</li> </ul>
<p><b>11</b> <b>Lo t</b> sets the fluid's Low Temperature Alarm Limit.</p> <p><b>Range:</b> +3°C to +42°C <b>Factory Default:</b> 3°C</p> <ul style="list-style-type: none"> <li>Press <b>enter</b></li> <li>The display will flash between <b>Lo t</b> and <b>3</b></li> <li>If desired, use <b>←</b> to adjust the value</li> <li>Press <b>enter</b></li> </ul>	<p><b>12</b> <b>Hi P1</b> sets the Pump's High Pressure Discharge Alarm Limit.</p> <p><b>Range:</b> Varies by pump <b>Factory Default:</b> Varies by pump</p> <ul style="list-style-type: none"> <li>Press <b>enter</b></li> <li>The display will flash between <b>Hi P1</b> and the default</li> <li>If desired, use <b>←</b> to adjust the value</li> <li>Press <b>enter</b></li> </ul>	<p><b>13</b> <b>dELAY</b> is the length of time the pump can exceed the <b>Hi P1</b> Alarm Limit before shutting down.</p> <p><b>Range:</b> Varies by pump <b>Factory Default:</b> 0 seconds</p> <ul style="list-style-type: none"> <li>The display will flash between <b>dELAY</b> and <b>0</b></li> <li>If desired, use <b>←</b> to adjust the value</li> <li>Press <b>enter</b></li> <li><b>NOTE:</b> This feature is active only if the unit is configured to shut down, see Step 16.</li> </ul>
<p><b>14</b> <b>Lo P1</b> sets the Pump's Low Pressure Discharge Alarm Limit.</p> <p><b>Range:</b> Varies by pump <b>Factory Default:</b> Varies by pump</p> <ul style="list-style-type: none"> <li>Press <b>enter</b></li> <li>The display will flash between <b>Lo P1</b> and the default</li> <li>If desired, use <b>←</b> to adjust the default</li> <li>Press <b>enter</b></li> </ul>	<p><b>15</b> <b>dELAY</b> is the length of time the pump can exceed the <b>Lo P1</b> Alarm Limit before shutting down.</p> <p><b>Range:</b> 0 to 30 seconds <b>Factory Default:</b> 10 seconds</p> <ul style="list-style-type: none"> <li>The display will flash between <b>dELAY</b> and <b>10</b></li> <li>If desired, use <b>←</b> to adjust the value</li> <li>Press <b>enter</b></li> <li><b>NOTE:</b> This feature is active only if the unit is configured to shut down, see Step 16.</li> </ul>	<p><b>16</b> <b>ALR</b> configures the unit's reaction to temperature, pressure, and flow (optional) alarm limits - either shut down (fL) or continue to run (IndC). See Section 4 in the manual for more information.</p> <p><b>Range:</b> fL* or IndC** <b>Factory Default:</b> fL</p> <ul style="list-style-type: none"> <li>Press <b>enter</b></li> <li>The display will flash between <b>ALR</b> and <b>fL</b></li> <li>If desired, press <b>←</b> to display <b>IndC</b></li> <li>Press <b>enter</b></li> <li>*fL = fault (shut down)</li> <li>**IndC = indicate (continue to run)</li> </ul>
<p><b>17</b> <b>Sound</b> Turns the unit's audible alarm on or off.</p> <p><b>Range:</b> on or OFF <b>Factory Default:</b> on</p> <ul style="list-style-type: none"> <li>Press <b>enter</b></li> <li>The display will flash between <b>Sound</b> and <b>on</b></li> <li>If desired, press <b>←</b> to display <b>OFF</b></li> <li>Press <b>enter</b></li> </ul>	<p><b>18</b> <b>StArT</b> enables/disables auto restart.</p> <p><b>Range:</b> on or OFF <b>Factory Default:</b> OFF</p> <ul style="list-style-type: none"> <li>Press <b>enter</b></li> <li>The display will flash between <b>StArT</b> and <b>OFF</b></li> <li>If desired, press <b>←</b> to display <b>on</b></li> <li>Press <b>enter</b></li> </ul>	<p><b>19</b> <b>CARe</b> is used to set the preventative care cleaning frequency reminder for the unit's air and fluid filters.</p> <p><b>Range:</b> off, L1 - 1000 hours, L2 - 2000 hours, L3 - 3000 hours <b>Factory Default:</b> L1</p> <ul style="list-style-type: none"> <li>Press <b>enter</b></li> <li>The display will flash between <b>CARe</b> and <b>L1</b></li> <li>If desired, use <b>←</b> to change display to off, L2 or L3</li> <li>Press <b>enter</b></li> </ul>

**If applicable, see boxes on right to set up options. For units with Analog I/O (ACOM) refer to the additional quick start supplied with your unit.**

<p><b>20</b> <b>StORe</b></p> <ul style="list-style-type: none"> <li>Press <b>←</b> to save all settings</li> </ul> <p><b>The unit will automatically start.</b></p> <ul style="list-style-type: none"> <li>Press <b>←</b> to disregard all changes and restore the factory default values.</li> </ul> <p><b>The display will go blank.</b></p> <ul style="list-style-type: none"> <li>If desired, press <b>←</b> to restart the procedure.</li> </ul>	<p>The Setup procedure is now complete.</p> <p>When the unit starts the controller will display the process fluid temperature.</p> <p>If desired, you can change/verify the unit's setpoint by pressing <b>mode</b></p>	<p><b>SP</b></p> <p><b>SP</b> is used to adjust the setpoint.</p> <p><b>Range:</b> +5°C to +40°C <b>Factory Default:</b> +20°C</p> <ul style="list-style-type: none"> <li>The display will flash between <b>SP</b> and <b>20</b></li> <li>If desired, use <b>←</b> to change the setting</li> <li>Press <b>enter</b> to save the new setpoint and return to the temperature display</li> </ul>
--	---	--

**Option - Voltage — Step A**

<p><b>A</b> <b>HZ</b></p> <p><b>HZ</b> is used to identify the incoming frequency for units with P3 - P5 pumps and the capability to run on either 50 Hz or 60 Hz. The selected frequency automatically adjusts the firmware's fixed high pressure default setting.</p> <p><b>Range:</b> 50 Hz or 60 Hz <b>Factory Default:</b> 60 Hz</p> <ul style="list-style-type: none"> <li>Press <b>enter</b></li> <li>The display will flash between <b>HZ</b> and <b>60</b></li> <li>If needed, use <b>←</b> to change the frequency</li> <li>Press <b>enter</b></li> <li>If your unit does not have a flow transducer or serial communications see Step 20.</li> </ul>	<p><b>HIFLO</b> sets the high flow alarm limit.</p> <p><b>Range:</b> Varies by pump <b>Factory Default:</b> Varies by pump</p> <ul style="list-style-type: none"> <li>Press <b>enter</b></li> <li>The display will flash between <b>HIFLO</b> and the default</li> <li>If desired, use <b>←</b> to adjust the value</li> <li>Press <b>enter</b></li> </ul>
---	--

**Option - Flow Transducer — Steps B and C**

<p><b>B</b> <b>Hi FLO</b></p> <p><b>HIFLO</b> sets the high flow alarm limit.</p> <p><b>Range:</b> Varies by pump <b>Factory Default:</b> Varies by pump</p> <ul style="list-style-type: none"> <li>Press <b>enter</b></li> <li>The display will flash between <b>HIFLO</b> and the default</li> <li>If desired, use <b>←</b> to adjust the value</li> <li>Press <b>enter</b></li> </ul>	<p><b>C</b> <b>Lo FLO</b></p> <p><b>LoFLO</b> sets the low flow alarm limit.</p> <p><b>Range:</b> Varies by pump <b>Factory Default:</b> Varies by pump</p> <ul style="list-style-type: none"> <li>Press <b>enter</b></li> <li>The display will flash between <b>LoFLO</b> and the default</li> <li>If desired, use <b>←</b> to adjust the value</li> <li>Press <b>enter</b></li> <li>If your unit does not have serial communications see Step 20.</li> </ul>
--	--

**Option - Serial Communications (DCOM) — Steps D to I**

<p><b>D</b> <b>SER</b></p> <p><b>SER</b> is used to enable/disable and to configure serial communications mode.</p> <p><b>Range:</b> off, rS232, rS485 <b>Factory Default:</b> off</p> <ul style="list-style-type: none"> <li>Press <b>enter</b></li> <li>The display will flash between <b>SER</b> and <b>OFF</b></li> <li>If desired, use <b>←</b> to change the mode</li> <li>Press <b>enter</b></li> </ul>	<p><b>E</b> <b>BAUD</b></p> <p><b>BAUD</b> is used to select the baud rate (speed) for serial communication.</p> <p><b>Range:</b> 9600, 4800, 2400, 1200, 600, or 300 bits per second.</p> <ul style="list-style-type: none"> <li>Press <b>enter</b></li> <li>The display will flash between <b>BAUD</b> and <b>9600</b></li> <li>If desired, use <b>←</b> to change the rate</li> <li>Press <b>enter</b></li> </ul>
<p><b>F</b> <b>DATA</b></p> <p><b>DATA</b> is used to display the number of bits.</p> <p><b>Display:</b> 8</p> <ul style="list-style-type: none"> <li>Press <b>enter</b></li> <li>The display will flash between <b>dATA</b> and <b>8</b></li> <li>Press <b>enter</b></li> </ul>	<p><b>G</b> <b>StOP</b></p> <p><b>StOP</b> is used to indicate the number of stop bits.</p> <p><b>Range:</b> 2 or 1 <b>Factory Default:</b> 1</p> <ul style="list-style-type: none"> <li>Press <b>enter</b></li> <li>The display will flash between <b>StOP</b> and <b>1</b></li> <li>If desired, use <b>←</b> to change the setting</li> <li>Press <b>enter</b></li> </ul>
<p><b>H</b> <b>PAR</b></p> <p><b>PAR</b> is used as a means to check for communication errors.</p> <p><b>Range:</b> even, odd, or none <b>Factory Default:</b> none</p> <ul style="list-style-type: none"> <li>Press <b>enter</b></li> <li>The display will flash between <b>PAR</b> and <b>none</b></li> <li>If desired, use <b>←</b> to change the setting</li> <li>Press <b>enter</b></li> </ul>	<p><b>I</b> <b>u id</b></p> <p><b>u id</b> (unit id) is used in RS485 only, identifies devices connected to the RS485 port.</p> <p><b>Range:</b> 1 to 99 <b>Factory Default:</b> 1</p> <ul style="list-style-type: none"> <li>Press <b>enter</b></li> <li>The display will flash between <b>u id</b> and <b>1</b></li> <li>If desired, use <b>←</b> to change the setting</li> <li>Press <b>enter</b></li> </ul> <p style="text-align: right;"><b>See Step 20.</b></p>





**Ce guide de démarrage rapide est destiné à la mise en marche initiale uniquement. Pour toute autre procédure, merci de vous référer au manuel. De plus, si l'une de ses étapes ne vous paraît pas claire, téléchargez le manuel avant de commencer.**

**Sécurité :**

- Les refroidisseurs ont été conçus pour fonctionner uniquement à l'intérieur. Ne jamais exposer le refroidisseur à une chaleur ou une humidité excessive, à une ventilation inadéquate ou à des matières corrosives.
- Brancher le refroidisseur à une prise correctement reliée à la terre.
- Les réfrigérants utilisés sont plus lourds que l'air et peuvent remplacer l'oxygène, provoquant ainsi une perte de conscience. Tout contact avec des réfrigérants qui fument peut provoquer des brûlures cutanées. Pour plus d'informations, se reporter à la plaque signalétique du refroidisseur et à la Fiche de données de sécurité (MSDS) du fabricant la plus couramment utilisée.
- Déplacer le refroidisseur avec soin. Les secousses soudaines et les chutes peuvent endommager ses composants. À chaque déplacement de l'équipement, toujours le mettre hors tension et le débrancher de son alimentation.
- Ne jamais utiliser un équipement endommagé ou qui présente des fuites.

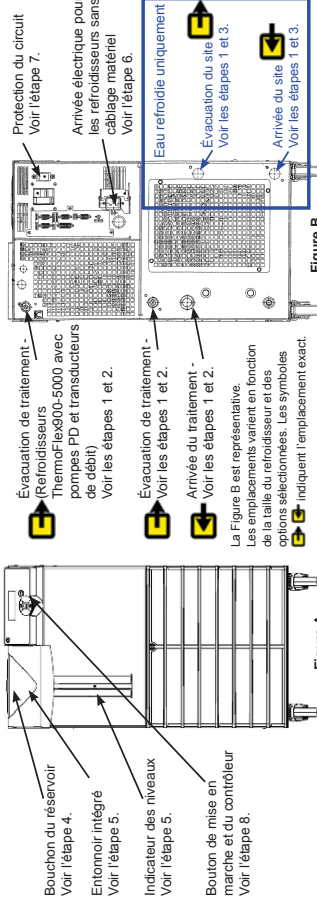

Figure A

1 Retirer tous les bouchons d'expédition en plastique (2 ou 4).

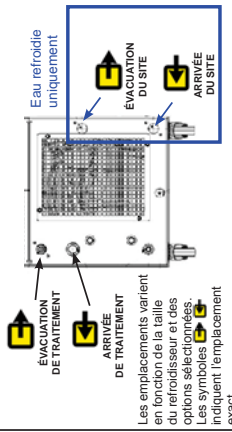
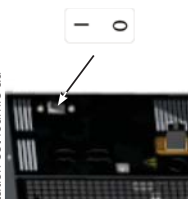

Figure B

5 Si le refroidisseur en est équipé, armer le disjoncteur GFCI en option et situé à l'arrière de l'appareil en position haute. Pour les refroidisseurs ThermoFlex900 jusqu'à 10000, mettre le dispositif de protection du circuit sur la position (I). L'affichage du contrôleur indique une série de barres de défillement ( ). Les barres indiquent le niveau de défillement du refroidisseur ; cette opération prend environ 15 secondes. Pour les autres refroidisseurs, les barres s'affichent lorsque l'alimentation est fournie au refroidisseur.

Le dispositif de protection du circuit n'a pas été conçu pour déconnecter les appareils.



Voir la Figure B.

2 Raccorder l'ÉVACUATION DE TRAITEMENT ThermoFlex (A) à l'arrivée de liquide de l'application. Raccorder L'ARRIVÉE DE TRAITEMENT ThermoFlex (B) à l'évacuation de liquide de l'application. Vérifier que les raccords sont étanches et sûrs. Pour les refroidisseurs refroidis par air, passer à l'étape 4.

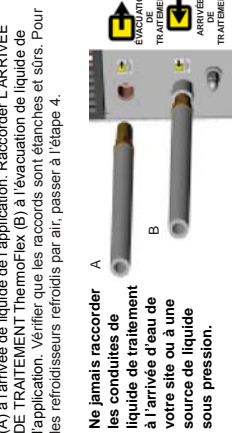

Voir la Figure B.

6 Ne jamais utiliser le refroidisseur sans liquide dans le réservoir et/ou sans avoir installé le filtre sac.

Merci de tirer avec précaution sur la partie plastique du cache type entornoir pour l'enlever et ensuite installer le filtre sac fourni. Une fois cette opération achevée, merci de repositionner le cache type entornoir.



Voir la Figure A.

3 Raccorder L'ÉVACUATION DU SITE ThermoFlex (A) à une évacuation d'eau du site. Raccorder L'ARRIVÉE DU SITE ThermoFlex (B) à une arrivée d'eau du site. Vérifier que les raccords sont étanches et sûrs.

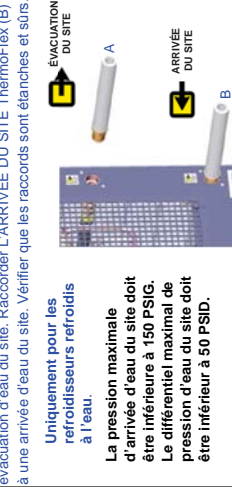

Voir la Figure B.

7 Remplir lentement le réservoir avec du liquide de traitement propre (voir le Tableau 1) en utilisant le regard pour contrôler facilement le niveau de liquide. Une fois le réservoir rempli, remettre le bouchon en le serrant à la main. La capacité du réservoir pouvant être réduite par rapport à l'application, et l'air devant être purgé des conduites, garder du liquide supplémentaire à portée de la main pour faire l'appoint du système une fois la circulation externe démarrée.

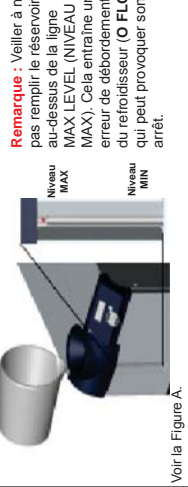

Voir la Figure A.

4 Se reporter à la plaque signalétique située à l'arrière du refroidisseur et vérifier que la tension est correcte. Pour les refroidisseurs fournis avec un cordon d'alimentation, insérer l'extrémité femelle de ce dernier dans le refroidisseur, et l'extrémité mâle dans la prise électrique. (Le cordon d'alimentation se trouve sous le couvercle de la caisse d'expédition. Ne pas jeter le couvercle avant d'avoir localisé le cordon).

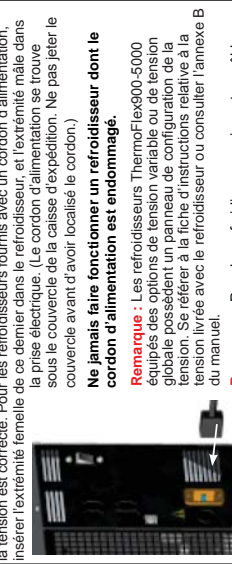

Voir la Figure B.

8 Appuyer sur le bouton du contrôleur affiche SETUP.

Remarque : Si le refroidisseur est équipé d'une cartouche de filtre de déionisation, consulter le manuel, Section 5, pour l'installation.

Voir au dos les étapes supplémentaires.



Voir la Figure A.

• Si le refroidisseur est équipé d'une pompe à déplacement positif (P1 ou P2), s'assurer que les conduites de plomberie et les raccords de l'application peuvent supporter au moins 185 psi.

• Ne pas utiliser de cartouche de filtre de déionisation (DI) avec EG ou PG inhibés. Un filtre DI retiendra les inhibiteurs de la solution, rendant le liquide inefficace sur la protection contre la corrosion. Les inhibiteurs augmentent également la conductivité du liquide.

• Utiliser uniquement les liquides approuvés et énumérés dans le Tableau 1. Avant d'utiliser un quelconque liquide ou d'effectuer des travaux d'entretien susceptibles d'entraîner un contact avec le liquide, se reporter à la Fiche de données de sécurité du fabricant.

• Pour éviter toute congélation/glaçage de l'échangeur à plaques, les refroidisseurs ThermoFlex7500-24000 requièrent l'utilisation d'EG/eau 50/50 ou de PG/eau 50/50 à une température inférieure de 10°C à celle du traitement.

**Matériel nécessaire pour commencer :**

- Une clé à molette
- Alimentation et évacuation d'eau du site (pour les refroidisseurs refroidis par eau)
- Tuyau et accessoires de plomberie appropriés
- Colliers de serrage ou raccords de connexion de dimension appropriée
- Ruban adhésif au Teflon® ou produit étanchéifiant approprié

**Raccordements à l'eau du site (FNPT)**

- ThermoFlex1400 - 5000 Arrivée/Sortie fonte de bronze 0,5"
- ThermoFlex500 - 10000 Arrivée/Sortie fonte de bronze 0,75"
- ThermoFlex15000 - 24000 Arrivée fonte de bronze 0,75"
- ThermoFlex15000 - 24000 Sortie acier inoxydable 0,75"













































**Raccordements du fluide de traitement (FNPT)**

- | Sortie            | P1 P2 TO T1            | P1 P2 TO T1            |
|-------------------|------------------------|------------------------|
| TFlex900 - 10000  | fonte de bronze 0,5"   | fonte de bronze 0,5"   |
| TFlex3500 - 5000  | fonte de bronze 0,75 " | fonte de bronze 0,75 " |
| TFlex7500 - 24000 | P3 P4                  | P3 P4                  |
|                   | P3 P5 T5               | P3 P5 T5               |
- Arrivée - Taille identique à la sortie de tous les refroidisseurs en acier inoxydable
- Adaptateurs fournis
- P1 P2 TO T1 Polyéthylène 0,5" x 0,375" et Nylon 0,5" x 0,5"
  - P3 P4 MPT 0,75 x PVC cannelé 0,5
  - P3 P5 T5 MPT 1" x PVC cannelé 1" et MPT 1" x PVC cannelé 0,75"

**Tableau 1 - Liquides approuvés :**

Tout autre liquide annule la garantie du fabricant.
<b>Refrigerateurs température standard</b>
Eau filtrée/mono-distillée (pH 7-8)
Eau déionisée (1 à 3 MD-cm, compensée)
Eau distillée avec bloc de Nalco et ses inhibiteurs
Eau distillée avec chlore (5 ppm)
Ethylène glycol de qualité laboratoire/eau 0 à 75 %
Propylène glycol de qualité laboratoire/eau 0 à 75 %





**Démarrage rapide - Ne sert que pour le premier démarrage - effectuer les étapes 9 à 20 pour toutes les unités.**

<p><b>REMARQUE</b> : Certaines plages/valeurs par défaut dépendent de la pompe, voir la Section 4 du manuel. Une fois l'étape de configuration terminée, c'est-à-dire après avoir appuyé sur la touche  une deuxième fois, il devient impossible de recommencer l'étape pour effectuer des corrections. Vous pouvez faire des modifications après le démarrage de l'appareil.</p> <p> Appuyez sur  pour poursuivre la procédure de l'étape.</p>	<p><b>Units</b> représente les échelles de température, de débit de liquide (en option) et de pression. GPMLPM Échelles : PSI/Bar/KPAS Réglages d'usine par défaut : °C, Gallons, PSI Réglage d'usine par défaut : °C, Gallons, PSI</p> <p> Appuyez sur  L'affichage clignote en alternant Units (unités) et °C</p> <p>Au besoin, utilisez  pour passer à un affichage en °F</p> <p>Appuyez sur  pour passer à l'affichage suivant</p> <p>Procédez de la même façon pour les échelles de débit et de pression</p>	<p><b>Hi t</b> règle la limite d'alarme de haute température du liquide. Plage : +3°C à +42°C Réglage d'usine par défaut : +42°C</p> <p> Appuyez sur  L'affichage clignote en alternant Hi t et 42</p> <p>Au besoin, utilisez  pour modifier la valeur</p> <p>Appuyez sur  pour passer à l'affichage suivant</p>
<p><b>Lo t</b> règle la limite d'alarme de basse température du liquide. Plage : +3°C à +42°C Réglage d'usine par défaut : 3°C</p> <p> Appuyez sur  L'affichage clignote en alternant Lo t et 3</p> <p>Au besoin, utilisez  pour modifier la valeur</p> <p>Appuyez sur  pour poursuivre la procédure de l'étape.</p>	<p><b>Hi P1</b> règle la limite d'alarme de décharge haute pression de la pompe. Plage : Varie en fonction de la pompe Réglage d'usine par défaut : Varie en fonction de la pompe</p> <p> Appuyez sur  L'affichage clignote en alternant Hi P1 et la valeur par défaut</p> <p>Au besoin, utilisez  pour modifier la valeur</p> <p>Appuyez sur  pour passer à l'affichage suivant</p>	<p><b>dELAY</b> représente la durée pendant laquelle la pompe peut dépasser la valeur d'alarme Hi P1 avant l'arrêt.</p> <p>Plage : Varie en fonction de la pompe Réglage d'usine par défaut : 0 secondes</p> <p> L'affichage clignote en alternant dELAY et 0</p> <p>Au besoin, utilisez  pour modifier la valeur</p> <p>Appuyez sur  REMARQUE Cette fonction n'est active que si l'appareil est configuré pour l'arrêt, voir l'étape 16.</p>
<p><b>Lo P1</b> règle la limite d'alarme de décharge basse pression de la pompe. Plage : Varie en fonction de la pompe Réglage d'usine par défaut : Varie en fonction de la pompe</p> <p> Appuyez sur  L'affichage clignote en alternant Lo P1 et la valeur par défaut</p> <p>Au besoin, utilisez  pour ajuster la valeur par défaut</p> <p>Appuyez sur  pour poursuivre la procédure de l'étape.</p>	<p><b>dELAY</b> représente la durée pendant laquelle la pompe peut dépasser la limite d'alarme avant arrêt. Plage : 0 à 30 secondes Réglage d'usine par défaut : 10 secondes</p> <p> L'affichage clignote en alternant dELAY et 10</p> <p>Au besoin, utilisez  pour modifier la valeur</p> <p>Appuyez sur  REMARQUE Cette fonction n'est active que si l'appareil est configuré pour l'arrêt, voir l'étape 16.</p>	<p><b>ALR</b> configure la réaction de l'appareil aux limites d'alarme de température, de pression, et de débit (en option) - terme (fL) ou continue l'exécution (InDC). Voir la section 4 du manuel pour des informations plus détaillées. Plage : fL* ou InDC** Réglage d'usine par défaut : fL</p> <p> Appuyez sur  L'affichage clignote en alternant ALR et fL</p> <p>Au besoin, utilisez  pour afficher InDC</p> <p>Appuyez sur  *fL = erreur (arrêt) ** InDC = indiquer (poursuite de l'exécution)</p>
<p><b>Active ou désactive le signal sonore d'alarme de l'appareil.</b> Plage : on (marche) ou OFF (ARRÊT) Réglage d'usine par défaut : on (marche)</p> <p> Appuyez sur  L'affichage clignote en alternant Sound et on (marche)</p> <p>Au besoin, appuyez sur  pour afficher OFF (ARRÊT)</p> <p>Appuyez sur  pour poursuivre la procédure de l'étape.</p>	<p><b>StArE</b> active/désactive le redémarrage automatique. Plage : on (marche) ou OFF (ARRÊT) Réglage d'usine par défaut : OFF (ARRÊT)</p> <p> Appuyez sur  L'affichage clignote en alternant StArE et OFF (ARRÊT)</p> <p>Au besoin, appuyez sur  pour afficher on (marche)</p> <p>Appuyez sur  pour passer à l'affichage suivant</p>	<p><b>CARÉ</b> sert à définir le rappel de nettoyage d'entretien préventif pour les filtres à air. Plage : L1, L2 ou L3 Réglage d'usine par défaut : L1</p> <p> Appuyez sur  L'affichage clignote en alternant CARÉ et L1</p> <p>Au besoin, utilisez  pour modifier l'affichage sur arrêt. L2 ou L3</p> <p>Appuyez sur  pour passer à l'affichage suivant</p>











**S'il y a lieu, consultez les cadres de droite pour définir des options. Pour les appareils I/O analogiques (ACOM) consultez la documentation de démarrage rapide supplémentaire fournie avec l'appareil.**

<p> Appuyez sur  pour enregistrer tous les réglages</p> <p><b>L'appareil démarre automatiquement.</b></p> <p>Appuyez sur  pour ignorer toutes les modifications et rétablir les valeurs par défaut d'usine. L'affiche est vide.</p> <p>Appuyez sur  pour recommencer la procédure</p>	<p>La procédure de configuration est désormais terminée.</p> <p>Au démarrage de l'appareil, le contrôleur affiche la température du liquide de l'application.</p> <p>Au besoin, vous pouvez changer/vérifier la valeur de consigne de l'appareil en appuyant sur </p>	<p><b>SP</b> sert à régler la valeur de consigne. Plage : +5°C à +40°C Réglage d'usine par défaut : +20°C</p> <p> L'affichage clignote en alternant SP et 20</p> <p>Au besoin, utilisez  pour modifier le réglage</p> <p>Appuyez sur  pour enregistrer la nouvelle valeur de consigne et revenir à l'affichage de la température</p>
---	--	---



















**Option - Tension globale - Étape A**

<p> HZ sert à identifier la fréquence d'entrée pour les unités de tension globales. La fréquence sélectionnée ajuste automatiquement le réglage de haute pression par défaut fixe du microprogramme. Plage : 50 ou 60 Hz Par défaut : 60 Hz</p> <p> Appuyez sur  L'affichage clignote en alternant HZ et 60</p> <p>Au besoin, utilisez  pour modifier la fréquence</p> <p>Appuyez sur  Si votre appareil n'est pas équipé d'un transducteur de débit ou de communications série, voir l'étape 20.</p>
--

**Option - Transducteur de débit - étapes B et C**

<p> HiFlo définit la limite d'alarme de débit élevé. Réglage d'usine par défaut : Varie en fonction de la pompe</p> <p> Appuyez sur  L'affichage clignote en alternant HiFlo et la valeur par défaut</p> <p>Au besoin, utilisez  pour modifier la valeur</p> <p>Appuyez sur  Si l'unité ne comporte pas de communications série, voir l'étape 20.</p>	<p> LoFlo définit la limite d'alarme de faible débit. Réglage d'usine par défaut : Varie en fonction de la pompe</p> <p> Appuyez sur  L'affichage clignote en alternant LoFlo et la valeur par défaut</p> <p>Au besoin, utilisez  pour modifier la valeur</p> <p>Appuyez sur  Si l'unité ne comporte pas de communications série, voir l'étape 20.</p>
--	---

**Option - Communications série (DCOM) - étapes D à I**

<p> SEr sert à activer/désactiver et à configurer le mode de communications série. Plage : of, rS232, rS485 Réglage d'usine par défaut : of</p> <p> Appuyez sur  L'affichage clignote en alternant SEr et OFF (ARRÊT)</p> <p>Au besoin, utilisez  pour modifier le mode</p> <p>Appuyez sur  dAtA sert à indiquer le nombre de bits d'arrêt. Affichage : 8</p>	<p> BAud sert à sélectionner le débit (la vitesse) de communication série. Plage : 9600, 4800, 2400, 1200, 600 ou 300 bits par seconde. Réglage d'usine par défaut : 9600</p> <p> Appuyez sur  L'affichage clignote en alternant BAud et 9600</p> <p>Au besoin, utilisez  pour modifier le débit</p> <p>Appuyez sur  StOp sert à indiquer le nombre de bits d'arrêt. Plage : 2 ou 1 Réglage d'usine par défaut : 1</p>
<p> dAtA sert à indiquer le nombre de bits d'arrêt. Affichage : 8</p> <p> Appuyez sur  L'affichage clignote en alternant dAtA et 8</p> <p>Appuyez sur  PAr sert de moyen de vérification des erreurs de communication. Plage : pair, impair, ou aucun Réglage d'usine par défaut : aucun</p>	<p> uId (identification de l'appareil) sert uniquement en RS485. Identifie les appareils raccordés au port RS485. Plage : 1 à 99 Réglage d'usine par défaut : 1</p> <p> Appuyez sur  L'affichage clignote en alternant uId et 1</p> <p>Au besoin, utilisez  pour modifier le réglage</p> <p>Appuyez sur  Voir l'étape 20.</p>





**Diese Kurzanleitung ist nur für die erste Inbetriebnahme vorgesehen. Für alle anderen Verfahren müssen Sie im Handbuch nachsehen. Auch wenn irgendwelche Schritte unverstandlich sind, laden Sie das Handbuch herunter, bevor Sie fortfahren.**

**Sicherheit:**

- Das Kuhlergerat darf nur in geschlossenen Raumen betrieben werden. Stellen Sie das Kuhlergerat niemals an Orten auf, wo es ubermaiger Hitze, Feuchtigkeit, unzureichender Beluftung oder korrosiven Stoffen ausgesetzt ist.
- Schlieen Sie das Kuhlergerat an eine ordnungsgema geerdete Steckdose an.
- Da die verwendeten Kuhlmittel schwerer als Luft sind und den Sauerstoff verdrangen, kann es zu Bewusstlosigkeit kommen. Der Kontakt mit austretendem Kuhlmittel kann Hautverbrennungen verursachen. Weitere Informationen finden Sie zur dem Typenschild des Kuhlergerates sowie im aktuellen Sicherheitsdatenblatt (SDS) des Herstellers.
- Bewegen Sie das Kuhlergerat vorsichtig. Plotzliche Erschutterungen oder Sturze konnen seine Bauteile beschadigen. Schalten Sie das Gerat immer ab und trennen Sie es von der Versorgungsspannung, bevor Sie das Gerat bewegen.
- Betreiben Sie niemals beschadigte oder undichte Gerate.



Abbildung A

Abbildung B

- Falls Ihr Kuhlergerat mit einer Verdangerpumpe (P1 oder P2) ausgestattet ist, stellen Sie sicher, dass die Leitungen und Anschlusse einem Druck von mindestens 185 psi/12,8 bar standhalten.
- Verwenden Sie keine Deionisierung (DI)-Filterkartusche bei inhibiertem EG oder inhibiertem PG. Mit einem DI-Filter werden Inhibitoren aus der Losung entfernt und dadurch wird die Korrosionsschutzwirkung der Flussigkeit aufgehoben. Inhibitoren erhohen auch die Leitfahigkeit der Flussigkeit.
- Verwenden Sie nur die in Tabelle 1 gezeigten zugelassenen Flussigkeiten. Beachten Sie die im Sicherheitsdatenblatt des Herstellers beschriebenen Vorsichtsmanahmen, bevor Sie Flussigkeiten einsetzen oder eine Wartung durchfuhren, bei der Sie moglicherweise mit Flussigkeiten in Beruhrung kommen...
- Um ein Einfrieren bzw. Vereisen des Plattenwarmetauschers zu vermeiden, mussen bei Betriebstemperaturen unter 10 °C fur ThermoFlex 7500-24000 Kuhlergerate 50/50 EG/Wasser oder 50/50 PG/Wasser verwendet werden.

**Sie benotigen fur die Inbetriebnahme:**

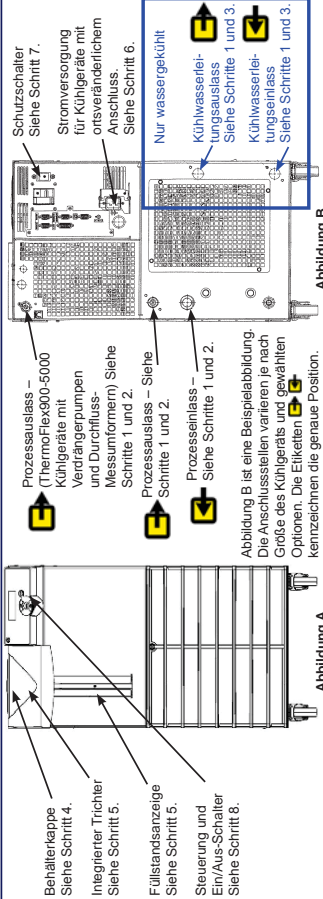
- Einen verstellbaren Schraubenschlussel
- Leitungswasserschu- und -ablauf (wassergekuhlte Kuhlergerate)
- Passende Schlauche bzw. Leitungen
- Passende Klemmen oder Anschlussstucke
- Teflon®-Band oder geeignete Dichtungen

**Kuhlwasserleitungsanschlusse (FNPT)**

- ThermoFlex 1400 – 5000 Einlass/Auslass 3/4" Gussbronze
- ThermoFlex 500 – 10000 Einlass/Auslass 3/4" Gussbronze
- ThermoFlex 7500 – 24000 Einlass 3/4" Gussbronze
- ThermoFlex 5000 – 24000 Auslass 3/4" Gussbronze
- ThermoFlex 5000 – 24000 Auslass 3/4" Edelstahl

**Anschlusse fur Prozessflussigkeiten (FNPT)**

- TFlex900 – 10000 P1 P2 TO T1
- TFlex3500 – 5000 P3 P4
- TFlex7500 – 24000 P3 P5 T5
- Mitgelieferte Adapter
- 1 1/2" x 3/8" Polyethylen und 1 1/2" x 1/2" Nylon
- 3/4" Außengewinde x 1/2" PVC-Verbindungsstuck
- P3 P5 T5 1" Außengewinde x 1" PVC-Verbindungsstuck und 1" Außengewinde x 3/4" PVC-Verbindungsstuck

<b>Tabelle 1 – Zugelassene Flussigkeiten:</b> Jede andere Flussigkeit fuhrt zum Verlust der Herstellergarantie.
<b>Standardtemperaturkuhlergerate</b> Filtertes/einfach desilliertes Wasser (pH 7–8) Desilliertes Wasser (1–3 MQ-cm, kompensiert) Desilliertes Wasser mit Nalco Biozid und Inhibitor Desilliertes Wasser mit Chlor (5 ppm) 0 – 75 % Ethylenglykol/Wasser in Laborqualitat 0 – 75 % Propylenglykol/Wasser in Laborqualitat
<b>Hochtemperaturkuhlergerate</b> Filtertes Wasser (pH 7–8)* 0 – 50% Ethylenglykol/Wasser in Laborqualitat 0 – 50% Propylenglykol/Wasser in Laborqualitat *bis 88 °C fur Kuhlergerate mit P1- und P2-Pumpen *bis 90 °C fur Kuhlergerate mit anderen Pumpen

**1** Entfernen Sie alle Kunststoff-Versandstopfen (2 oder 4).

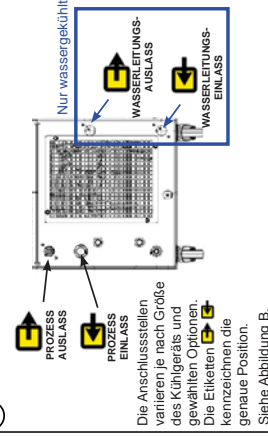

Siehe Abbildung B.

**5** Falls vorhanden, stellen Sie den optionalen FI-Schutzhalter in die obere Position. Bei ThermoFlex900 bis 10000 Kuhlergeraten stellen Sie den Schalter in die Position Ein (I). Die Steuerung zeigt eine Reihe laufender Balken an ( ). Die Balken laufen aufwarts, um anzuzeigen, dass das Kuhlergerat initialisiert wird. Dieser Vorgang dauert ca. 15 Sekunden. Bei anderen Kuhlergeraten erscheinen die Balken, wenn das Kuhlergerat mit Strom versorgt wird.

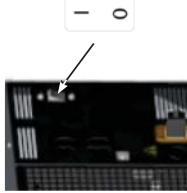

**Der Schutzhalter ist nicht zum Ausschalten des Gerates vorgesehen.**

Siehe Abbildung B.

**2** Verbinden Sie den ThermoFlex PROZESSAUSGANG (A) mit dem Flussigkeitseingang Ihrer Applikation. Verbinden Sie den ThermoFlex PROZESS-EINGANG (B) mit dem Flussigkeitsausgang Ihrer Applikation. Uberprufen Sie, dass die Verbindungen dicht und gesichert sind. Luftgekuhlte Kuhlergerate: Weiter mit Schritt 4.

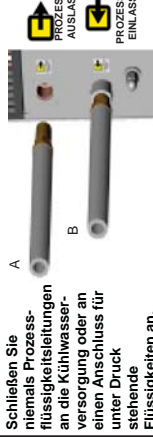

Siehe Abbildung B.

**6** Betreiben Sie niemals den Kuhler ohne Prozessflussigkeit im Behalter oder ohne installierten Flussigkeitfilter.

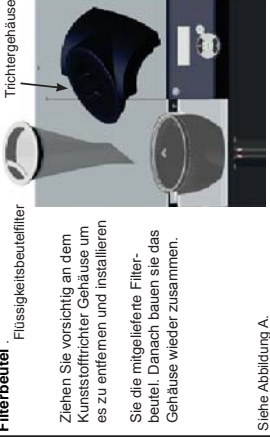

Ziehen Sie vorsichtig an dem Kunststofflicher Gehause um es zu entfernen und installieren es zu entfernen und installieren

Sie die mitgelieferte Filterbeutel. Danach bauen sie das Gehause wieder zusammen.

Siehe Abbildung A.

**3** Verbinden Sie den ThermoFlex KUHLWASSERLEITUNGS-AUSLAUSS (A) mit Ihrem Wasserrucklauf oder -abfluss. Verbinden Sie den ThermoFlex KUHLWASSERLEITUNGS-EINLAUSS (B) mit einer Wasserleitung. Uberprufen Sie, dass die Verbindungen dicht und gesichert sind.



Siehe Abbildung B.

**Nur wassergekuhlt.**

Der maximale Einlassdruck des Kuhlers darf 10,35 bar nicht uberschreiten. Die maximale Druckdifferenz des Kuhlers darf 3,4 bar nicht uberschreiten.

**7** Befullen Sie den Behalter langsam mit sauberer Prozessflussigkeit (siehe Tabelle 1) und kontrollieren Sie den Fullstand uber die Fullstandsanzeige. Wenn der Behalter voll ist, schrauben Sie die Behalterkappe handfest auf. Da moglicherweise die Kapazitat des Behalters im Vergleich zu Ihrer Applikation eher gering ist und Luft aus den Leitungen gespult werden muss, sollten Sie weitere Flussigkeit zum Nachfullen bereithalten, wenn der externe Kreislauf gestartet wird.

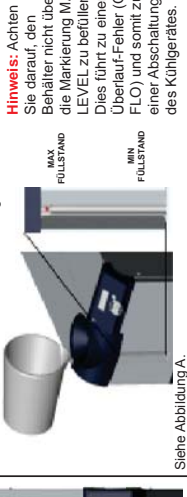

Siehe Abbildung A.

**Hinweis:** Achten Sie darauf, den Behalter nicht uber die Markierung MAX LEVEL zu befullen. Dies fuhrt zu einem Uberlauf-Fehler (O FLO) und somit zu einer Abschaltung des Kuhlergerates.

**4** Kontrollieren Sie, ob die korrekte Spannung eingestellt ist. Die Sie auf dem Typenschild auf der Ruckseite des Kuhlergerates finden. Stecken Sie bei Kuhlergeraten mit Stromkabel zunachst das gerateneigene Ende in das Kuhlergerat und anschlieend den Stecker in eine Steckdose. Das Stromkabel befindet sich unter dem Deckel der Transportkiste. Werfen Sie den Deckel nicht weg, bevor Sie das Stromkabel gefunden haben.)



Siehe Abbildung B.

**Bearbeiten Sie das Kuhlergerat niemals mit einem beschadigten Stromkabel.**

**Hinweis:** ThermoFlex900-5000 Kuhlergerate mit der Option Variabler Spannungsbereich verfugen uber ein Bedienfeld zur Konfiguration der Spannung. Siehe mitgelieferte Anweisung zum Einstellen der Spannung oder Anhang B im Handbuch.

**Hinweis:** Fur Kuhlergerate, bei denen ein Festanschluss erforderlich ist, siehe Abschnitt 3 im Handbuch.

**8** Drucken Sie auf

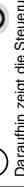

Daraufhin zeigt die Steuerung **SETUP** oder **SCHNELLSTART** an.

**Hinweis:** Falls das Kuhlergerat mit einer Deionisierung-Filterkartusche ausgestattet ist, uberprufen Sie die Flussigkeit im Behalter. Siehe Abschnitt 5 des Handbuchs.

Weitere Schritte siehe Ruckseite.



Siehe Abbildung A.

**Schnellstart - Nur für die erste Inbetriebnahme — führen Sie die Schritte 9 bis 20 für alle Geräte aus.**

<p><b>9</b> <b>Units</b> sind die Einheiten für Temperatur, Flüssigkeitsdurchfluss (optional) und Druck. Einheiten: °C/F GPW/LPM PSIBar/KPAS Werkseinstellungen: °C, Gallonen, PSI</p> <p>• Drücken Sie <b>enter</b></p> <p>• Die Anzeige blinkt und zeigt abwechselnd Units und °C an</p> <p>• Falls erforderlich, drücken Sie <b>↔</b>, um die Skala auf °F umzuschalten</p> <p>• Drücken Sie <b>enter</b>, um zur nächsten Anzeige zu wechseln</p> <p>• Wiederholen Sie den Vorgang für die Skalen Flow (Durchfluss) und Pressure (Druck)</p>	<p><b>10</b> <b>Hi L</b></p> <p>Über Hi wird die Alarmschwelle für den Übertemperaturalarm der Flüssigkeit eingestellt. Bereich: +3°C bis +42°C Werkseinstellung: +42°C</p> <p>• Drücken Sie <b>enter</b></p> <p>• Die Anzeige blinkt und zeigt abwechselnd Hi t und 42 an</p> <p>• Falls erforderlich, drücken Sie <b>↔</b>, um den Wert einzustellen</p> <p>• Drücken Sie <b>enter</b>, um zur nächsten Anzeige zu wechseln</p>	<p><b>11</b> <b>Lo t</b></p> <p>Über Lo t wird die Alarmschwelle für niedrige Flüssigkeitstemperatur eingestellt. Bereich: +3°C bis +42°C Werkseinstellung: 3°C</p> <p>• Drücken Sie <b>enter</b></p> <p>• Die Anzeige blinkt und zeigt abwechselnd Lo t und 3 an</p> <p>• Falls erforderlich, drücken Sie <b>↔</b>, um den Wert einzustellen</p> <p>• Drücken Sie <b>enter</b></p>	<p><b>12</b> <b>Hi Pi</b></p> <p>Über Hi Pi wird die Alarmschwelle für die Entlastung der Pumpe bei hohem Druck eingestellt. Bereich: Je nach Pumpe verschieden</p> <p>• Drücken Sie <b>enter</b></p> <p>• Die Anzeige blinkt und zeigt abwechselnd Hi P1 und den Standardwert an</p> <p>• Falls erforderlich, drücken Sie <b>↔</b>, um den Wert einzustellen</p> <p>• Drücken Sie <b>enter</b></p>	<p><b>13</b> <b>dELAY</b></p> <p>dELAY gibt an, wie lange die Pumpe nach Überschreiten der P1 Alarmschwelle noch weiterläuft, bevor sie abschaltet. Bereich: Je nach Pumpe verschieden Werkseinstellung: 0 Sekunden</p> <p>• Die Anzeige blinkt und zeigt abwechselnd dELAY und 0 an</p> <p>• Falls erforderlich, drücken Sie <b>↔</b>, um den Wert einzustellen</p> <p>• Drücken Sie <b>enter</b></p> <p>HINWEIS: Diese Funktion ist nur aktiv, wenn das Gerät auf Abschalten konfiguriert ist, siehe Schritt 16.</p>	<p><b>14</b> <b>Lo Pi</b></p> <p>Über Lo Pi wird die Alarmschwelle für die Entladung der Pumpe bei niedrigem Druck eingestellt. Bereich: Je nach Pumpe verschieden</p> <p>• Drücken Sie <b>enter</b></p> <p>• Die Anzeige blinkt und zeigt abwechselnd Lo P1 und den Standardwert an</p> <p>• Falls erforderlich, drücken Sie <b>↔</b>, um den Wert einzustellen</p> <p>• Drücken Sie <b>enter</b></p>	<p><b>15</b> <b>dELAY</b></p> <p>dELAY gibt an, wie lange die Pumpe nach Überschreiten der Lo P1 Alarmschwelle noch weiterläuft, bevor sie abschaltet. Bereich: 0 bis 30 Sekunden Werkseinstellung: 10 Sekunden</p> <p>• Die Anzeige blinkt und zeigt abwechselnd dELAY und 10 an</p> <p>• Falls erforderlich, drücken Sie <b>↔</b>, um den Wert einzustellen</p> <p>• Drücken Sie <b>enter</b></p> <p>HINWEIS: Diese Funktion ist nur aktiv, wenn das Gerät auf Abschalten konfiguriert ist, siehe Schritt 16.</p>	<p><b>16</b> <b>ALR</b></p> <p>ALR konfiguriert die Reaktion des Geräts auf Temperatur-, Druck- und (optional) Durchfluss-Alarmlösungen - entweder Abschaltung (fL) oder Betrieb fortsetzen (indC). Weitere Informationen siehe Abschnitt 4 im Handbuch. Bereich: fL* oder indC** Werkseinstellung: fL</p> <p>• Drücken Sie <b>enter</b></p> <p>• Die Anzeige blinkt und zeigt abwechselnd ALR und fL an</p> <p>• Falls gewünscht, drücken Sie <b>↔</b>, um indC anzuzeigen</p> <p>• Drücken Sie <b>enter</b></p> <p>*fL = Fehler (Abschalten) **indC = Anzeigen (Betrieb fortsetzen)</p>	<p><b>17</b> <b>Sound</b></p> <p>Schalten den akustischen Alarm des Geräts ein bzw. aus. Bereich: on oder OFF Werkseinstellung: on</p> <p>• Drücken Sie <b>enter</b></p> <p>• Die Anzeige blinkt und zeigt abwechselnd Sound und ON an</p> <p>• Falls gewünscht, drücken Sie <b>↔</b>, um OFF anzuzeigen</p> <p>• Drücken Sie <b>enter</b></p>	<p><b>18</b> <b>StArE</b></p> <p>Über StArE wird der automatische Neustart ein- bzw. ausgeschaltet. Bereich: on oder OFF Werkseinstellung: OFF</p> <p>• Drücken Sie <b>enter</b></p> <p>• Die Anzeige blinkt und zeigt abwechselnd StArE und OFF an</p> <p>• Falls gewünscht, drücken Sie <b>↔</b>, um ON anzuzeigen</p> <p>• Drücken Sie <b>enter</b></p>	<p><b>19</b> <b>CARe</b></p> <p>Über CARe wird das Erinnerungsintervall für die vorbeugende Reinigung der Luft- und Flüssigkeitsfilter des Geräts eingestellt. Bereich: off, L1 - 1000 Stunden, L2 - 2000 Stunden, L3 -3000 Stunden Werkseinstellung: L1</p> <p>• Drücken Sie <b>enter</b></p> <p>• Die Anzeige blinkt und zeigt abwechselnd CARe und L1 an</p> <p>• Falls erforderlich, drücken Sie <b>↔</b>, um die Anzeige auf OFF, L2 oder L3 zu ändern</p> <p>• Drücken Sie <b>enter</b></p>	<p><b>20</b> <b>SP</b></p> <p>Über SP wird der Sollwert eingestellt. Bereich: +5°C bis +40°C Werkseinstellung: +20°C</p> <p>• Die Anzeige blinkt und zeigt abwechselnd SP und 20 an</p> <p>• Falls erforderlich, drücken Sie <b>↔</b>, um die Einstellung zu ändern</p> <p>• Drücken Sie <b>enter</b>, um den neuen Sollwert zu speichern und zur Anzeige der Temperatur zurückzukehren</p>
--	---	---	---	--	--	---	---	--	--	---	---

**Falls zutreffend, stellen Sie die Optionen entsprechend den Feldern auf der rechten Seite ein. Für Geräte mit analogen Ein- und Ausgängen (ACOM) siehe mitgelieferte zusätzliche Hinweise für den Schnellstart.**

<p><b>20</b> <b>Store</b></p> <p>Drücken Sie <b>enter</b>, um alle Einstellungen zu speichern</p> <p><b>Das Gerät startet automatisch.</b></p> <p>Drücken Sie <b>↔</b>, um alle Änderungen zu verwirklichen und zu den Werks-Standard-Einstellungen zurückzukehren. Die Anzeige bleibt leer.</p> <p>Drücken Sie <b>enter</b>, um den Vorgang neu zu starten</p>	<p>Der Setup-Vorgang ist nun abgeschlossen.</p> <p>Beim Start des Geräts wird die Temperatur der Prozessflüssigkeit angezeigt.</p> <p>Falls gewünscht, können Sie den Sollwert ändern/bestätigen.</p>	<p><b>21</b> <b>PAR</b></p> <p>PAR wird verwendet, um Fehler in der Datenübertragung zu finden. Bereich: gleich, ungleich oder keine Werkseinstellung: keine</p> <p>• Drücken Sie <b>enter</b></p> <p>• Die Anzeige blinkt und zeigt abwechselnd PAR und none an</p> <p>• Falls erforderlich, drücken Sie <b>↔</b>, um die Einstellung zu ändern</p> <p>• Drücken Sie <b>enter</b></p>
---	---	--

<p><b>Option - Variabler Spannungsbereich — Schritt A</b></p> <p><b>A</b> <b>Hz</b></p> <p>Über Hz wird bei Geräten mit variablem Spannungsbereich die Frequenz des Stromnetzes angegeben. Über die gewählte Frequenz wird die festgelegte Überdruck-Standard-Einstellung der Firmware automatisch justiert. Bereich: 50 oder 60 Hz Standard: 60 Hz</p> <p>• Drücken Sie <b>enter</b></p> <p>• Die Anzeige blinkt und zeigt abwechselnd Hz und 60 an</p> <p>• Falls erforderlich, drücken Sie <b>↔</b>, um die Frequenz zu ändern</p> <p>• Drücken Sie <b>enter</b></p> <p>Wenn Ihr Gerät nicht über einen Durchfluss-Messumformer oder serielle Kommunikation verfügt, siehe Schritt 20.</p>
---

<p><b>Option - Durchfluss-Messumformer — Schritte B und C</b></p> <p><b>B</b> <b>Hi FLo</b></p> <p>Über Hi FLo wird die Alarmschwelle für hohen Durchfluss eingestellt. Bereich: Je nach Pumpe verschieden</p> <p>• Drücken Sie <b>enter</b></p> <p>• Die Anzeige blinkt und zeigt abwechselnd Hi FLO und den Standardwert an</p> <p>• Falls erforderlich, drücken Sie <b>↔</b>, um den Wert einzustellen</p> <p>• Drücken Sie <b>enter</b></p>	<p><b>C</b> <b>Lo FLo</b></p> <p>Über Lo FLo wird die Alarmschwelle für niedrigen Durchfluss eingestellt. Bereich: Je nach Pumpe verschieden</p> <p>• Drücken Sie <b>enter</b></p> <p>• Die Anzeige blinkt und zeigt abwechselnd Lo FLO und den Standardwert an</p> <p>• Falls erforderlich, drücken Sie <b>↔</b>, um den Wert einzustellen</p> <p>• Drücken Sie <b>enter</b></p> <p>Wenn Ihr Gerät nicht über eine serielle Kommunikation verfügt, siehe Schritt 20.</p>
---	---

<p><b>Option - Serielle Kommunikation (DCOM) — Schritte D bis I</b></p> <p><b>D</b> <b>SER</b></p> <p>Über SER wird der Modus für die serielle Kommunikation ein- und ausgeschaltet und konfiguriert. Bereich: off, rS232, rS485 Werkseinstellung: off</p> <p>• Drücken Sie <b>enter</b></p> <p>• Die Anzeige blinkt und zeigt abwechselnd SER und OFF an</p> <p>• Falls erforderlich, drücken Sie <b>↔</b>, um den Modus zu ändern</p> <p>• Drücken Sie <b>enter</b></p>	<p><b>E</b> <b>BAUD</b></p> <p>Über BAUD wird die Baudrate (geschwindigkeit) für die serielle Kommunikation ausgewählt. Bereich: 9600, 4800, 2400, 1200, 600 oder 300 Bit pro Sekunde. Werkseinstellung: 9600</p> <p>• Drücken Sie <b>enter</b></p> <p>• Die Anzeige blinkt und zeigt abwechselnd BAUD und 9600 an</p> <p>• Falls erforderlich, drücken Sie <b>↔</b>, um die Baudrate zu ändern</p> <p>• Drücken Sie <b>enter</b></p>
---	---

<p><b>F</b> <b>dATA</b></p> <p>Über dATA wird die Anzahl der Bits angezeigt. Anzeige: 8</p> <p>• Drücken Sie <b>enter</b></p> <p>• Die Anzeige blinkt und zeigt abwechselnd dATA und 8 an</p> <p>• Drücken Sie <b>enter</b></p>	<p><b>G</b> <b>StOp</b></p> <p>Über StOp wird die Anzahl der Stopp-Bits angegeben. Bereich: 2 oder 1 Werkseinstellung: 1</p> <p>• Drücken Sie <b>enter</b></p> <p>• Die Anzeige blinkt und zeigt abwechselnd StOp und 1 an</p> <p>• Falls erforderlich, drücken Sie <b>↔</b>, um die Einstellung zu ändern</p> <p>• Drücken Sie <b>enter</b></p>
---	--

<p><b>H</b> <b>UID</b></p> <p>UID (Geräte-ID) wird nur bei RS485 verwendet, zur Identifizierung von Geräten, die an den Port RS485 angeschlossen werden. Bereich: 1 bis 99 Werkseinstellung: 1</p> <p>• Drücken Sie <b>enter</b></p> <p>• Die Anzeige blinkt und zeigt abwechselnd UID und 1 an</p> <p>• Falls erforderlich, drücken Sie <b>↔</b>, um die Einstellung zu ändern</p> <p>• Drücken Sie <b>enter</b></p> <p>Siehe Schritt 20.</p>	<p><b>I</b> <b>UID</b></p> <p>UID (Geräte-ID) wird nur bei RS485 verwendet, zur Identifizierung von Geräten, die an den Port RS485 angeschlossen werden. Bereich: 1 bis 99 Werkseinstellung: 1</p> <p>• Drücken Sie <b>enter</b></p> <p>• Die Anzeige blinkt und zeigt abwechselnd UID und 1 an</p> <p>• Falls erforderlich, drücken Sie <b>↔</b>, um die Einstellung zu ändern</p> <p>• Drücken Sie <b>enter</b></p> <p>Siehe Schritt 20.</p>
--	--





**Scopo di questa guida rapida è facilitare la messa in funzione iniziale. Per tutte le altre procedure è necessario fare riferimento al manuale. Se alcuni dei passaggi qui riportati non risultano chiari, scaricare il manuale prima di proseguire.**

**Sicurezza:**

- Il refrigeratore è progettato esclusivamente per l'uso al chiuso. Non posizionare mai il refrigeratore in un ambiente a temperature eccessivamente alte, umido, con ventilazione inadeguata o materiali corrosivi.
- Attaccare il refrigeratore a una presa correttamente collegata a massa.
- I refrigeranti utilizzati sono più pesanti dell'aria e sostituiranno l'ossigeno causando la perdita di coscienza. Il contatto con refrigeranti fuoriusciti causa ustioni della pelle. Per ulteriori informazioni, fare riferimento alla targhetta identificativa del refrigeratore e alla scheda di sicurezza dei materiali (MSDS) più recente.
- Spostare il refrigeratore con cautela. Cadute o urti improvvisi possono danneggiare i componenti. Spegnerne sempre l'apparecchiatura e scollegarla dalla tensione di alimentazione, prima di spostarla.
- Non azionare apparecchiature danneggiate o che presentano perdite.



Figura A



Figura B

- Se il refrigeratore è dotato di pompa volumetrica (P1 o P2), verificare che le tubazioni idrauliche e i raccordi previsti per l'applicazione siano progettati per sostenere una pressione minima di 185 psi.
- Non utilizzare una cartuccia filtro per deionizzazione (D) con etilenglicole o propilenglicole inibito. Il filtro di rimuove gli inibitori dalla soluzione rendendo il liquido inefficace contro la protezione dalla corrosione. Inoltre, gli inibitori aumentano la conduttività del liquido.
- Utilizzare solo i liquidi approvati riportati nella tabella 1. Prima di utilizzare liquidi o eseguire eventuali interventi di manutenzione che potrebbero implicare il contatto con il liquido, fare riferimento alle schede di sicurezza dei materiali (MSDS) del produttore per le precauzioni d'uso.
- Per impedire il congelamento dello scambiatore di calore a piastre, i refrigeratori ThermoFlex7500-24000 richiedono l'uso di 50/50 di etilenglicole/acqua o propilenglicole/acqua per temperature di processo inferiori a 10°C.

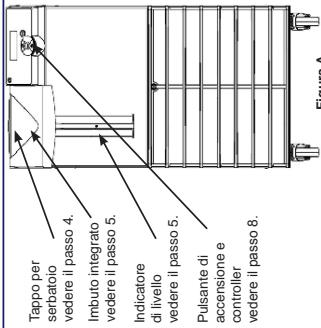
**Elementi necessari per la messa in funzione:**

- Una chiave regolabile
- Alimentazione e ritorno acqua dell'impianto (refrigeratori ad acqua)
- Tubazioni rigide o flessibili idonee
- Tipo di raccordi o dimensioni fascette adeguate
- Nastro adesivo Teflon® o sigillante idoneo

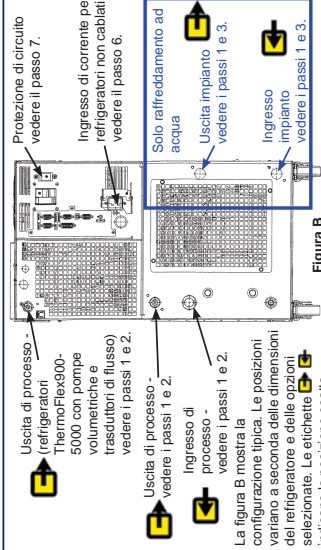
**Raccordi acqua dell'impianto (FNPT)**

- ThermoFlex1400 - 5000 Ingressi/uscite in bronzo fuso da 1/2"
- ThermoFlex7500 - 10000 Ingressi/uscite in bronzo fuso da 3/4"
- ThermoFlex15000 - 24000 Ingressi in bronzo fuso da 3/4"
- ThermoFlex15000 - 24000 Uscite in acciaio inossidabile da 3/4"

**Raccordi per liquidi di processo (FNPT) - Uscita**

- TFlex900 - 10000 P1 P2 T0 T1 in bronzo fuso da 1/2"
- TFlex3500 - 5000 P3 P4 in bronzo fuso da 3/4"
- TFlex7500 - 24000 P3 P5 T5 in rame lavorato da 1"

**Adattatori forniti**

- P1 P2 T0 T1 in polietilene da 1/2" x 3/8" e in nylon da 1/2" x 1/2"
- P3 P4 MPT 3/4 x raccordo dentato in PVC 1/2"
- P3 P5 T5 MPT 1" x raccordo dentato in PVC 1" e MPT 1" x raccordo dentato in PVC 3/4"

<b>Tabella 1 - Liquidi approvati:</b>
L'uso di qualsiasi altro liquido annullerà la garanzia del produttore.
<b>Refrigeratori a temperature standard</b>
Acqua distillata/filtrata (pH 7-8)
Acqua deionizzata (1-3 MQ-cm, compensata)
Acqua distillata con biocida o inibitore Nalco
Acqua distillata con doro (5 ppm)
0 - 75% etilenglicole/acqua per laboratorio
0 - 75% propilenglicole/acqua per laboratorio

**1** Rimuovere tutti i tappi di spedizione (2 o 4).

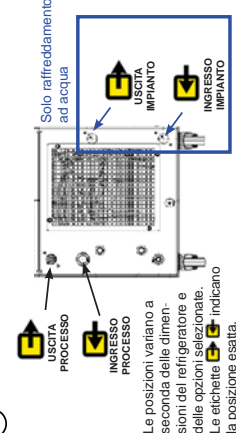

Le posizioni variano a seconda delle dimensioni del refrigeratore e delle opzioni selezionate. Le etichette A e B indicano la posizione esatta.

Vedere la figura B.

**5** Se in dotazione, portare l'interruttore GFCI opzionale situato sul retro nella posizione sollevata. Per i refrigeratori compresi tra ThermoFlex900 e 10000, portare la protezione di circuito nella posizione attiva (I). Il display del controller indicherà una serie di barre di scorrimento (≡). Le barre scorreranno verso l'alto a indicare l'inizializzazione del refrigeratore; operazione che richiederà circa 15 secondi. Per altri refrigeratori, le barre vengono visualizzate quando viene fornita l'alimentazione.

La protezione di circuito non è progettata per agire come strumento di scollegamento.

Vedere la figura B.

**2** Collegare l'USCITA DI PROCESSO ThermoFlex (A) all'ingresso liquidi per l'applicazione. Collegare l'INGRESSO DI PROCESSO ThermoFlex (B) all'uscita liquidi per l'applicazione. Verificare che i raccordi siano ben saldi e sigillati. Per i refrigeratori ad aria andare al passo 4.

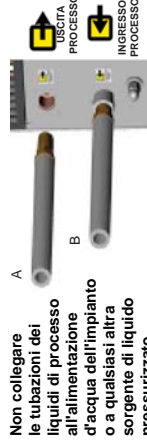

Non collegare le tubazioni dei liquidi di processo all'alimentazione d'acqua dell'impianto o a qualsiasi altra sorgente di liquido pressurizzato.

Vedere la figura B.

**6** Non utilizzare mai il chiller senza il liquido di raffreddamento nel serbatoio o senza avere installato il sacchetto filtro.



Estrarre con cautela l'alloggiamento in plastica dell'imbuvo per rimuoverlo e installare il sacchetto filtro in dotazione. Reinstallare nuovamente l'alloggiamento.

Vedere la figura A.

**3** Collegare l'USCITA IMPIANTO ThermoFlex (A) a una tubazione di ritorno o scarico dell'acqua dell'impianto. Collegare l'INGRESSO IMPIANTO ThermoFlex (B) all'alimentazione acqua dell'impianto. Verificare che i raccordi siano ben saldi e sigillati.



Solo per il raffreddamento ad acqua. La pressione di ingresso massima dell'acqua dell'impianto non deve superare i 150 PSIG. Il differenziale di pressione massimo dell'acqua dell'impianto non deve superare i 50 PSID.

Vedere la figura B.

**7** Riempire lentamente il serbatoio con liquido di processo pulito (vedere la tabella 1), utilizzando il tubo spia per controllare facilmente il livello del liquido. Quando il serbatoio è pieno, riapplicare il tappo e serrare a mano. Poiché la capacità del serbatoio potrebbe essere inferiore al necessario per l'applicazione interessata e l'aria potrebbe essere spurgata dalle tubazioni, tenere a portata di mano del liquido extra per rabboccare il sistema all'avvio del ricircolo esterno.

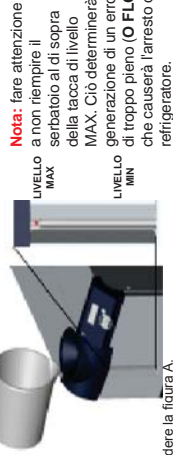

Nota: fare attenzione a non riempire il serbatoio al di sopra della tacca di livello MAX. Ciò determinerà la generazione di un errore di troppo pieno (O FLO) che causerà l'arresto del refrigeratore.

Vedere la figura A.

**4** Fare riferimento alla targhetta identificativa sul retro del refrigeratore e verificare la tensione corretta. Per i refrigeratori forniti con un cavo di alimentazione, inserire l'estremità femmina del cavo nel refrigeratore e l'estremità maschio nella presa di corrente. Il cavo di alimentazione si trova sotto il coperchio della cassa per la spedizione. Non gettare il coperchio fino a quando non si trova il cavo.)



**Non azionare il refrigeratore con un cavo di alimentazione danneggiato.**  
**Nota:** i refrigeratori ThermoFlex900-5000 dotati dell'opzione di tensione variabile o globale hanno un pannello di configurazione della tensione. Fare riferimento al foglio delle istruzioni relative alla tensione spedito con il refrigeratore o vedere l'Appendice B al manuale.  
**Nota:** per i refrigeratori che richiedono il cablaggio vedere la sezione 3 del manuale.

Vedere la figura B.

**8** Premere il controller viene visualizzato SETUP.

Nota: se il refrigeratore viene dotato di una cartuccia filtro per deionizzazione fare riferimento alla sezione 5 del manuale per informazioni sull'installazione. Consultare il retro per ulteriori procedure.



Vedere la figura A.

**Avvio rapido - solo per la messa in servizio iniziale — eseguire dal passo 9 al 20 per tutti i refrigeratori.**

<p><b>9</b> <b>Unit</b>                  UnitS sono le scale della temperatura, del flusso di liquido (opzionale) e della pressione.                  Scale: °C/°F    GPM/LPM                  PSI/Bar/KPAS</p> <ul style="list-style-type: none"> <li>• Premiere </li> <li>• Il display lampeggia tra UnitS e °C</li> <li>• Se desiderato, utilizzare  per modificare la scala in °F</li> <li>• Premiere  per passare al display successivo</li> <li>• Effettuare la stessa operazione per le scale di flusso e pressione</li> </ul>	<p><b>10</b> <b>Hi T</b>                  Hi T imposta il limite dell'allarme alta temperatura del liquido.                  Intervallo: Da +3°C a +42°C                  Impostazione predefinita dalla fabbrica: +42°C</p> <ul style="list-style-type: none"> <li>• Premiere </li> <li>• Il display lampeggerà tra Hi T e 42</li> <li>• Se desiderato, utilizzare  per regolare il valore</li> <li>• Premiere  per passare al display successivo</li> </ul>	<p><b>11</b> <b>Lo t</b>                  Lo t imposta il limite di allarme bassa temperatura del liquido.                  Intervallo: Da +3°C a +42°C                  Impostazione predefinita dalla fabbrica: 3°C</p> <ul style="list-style-type: none"> <li>• Premiere </li> <li>• Il display lampeggerà tra Lo t e 3</li> <li>• Se desiderato, utilizzare  per regolare il valore</li> <li>• Premiere </li> </ul>	<p><b>12</b> <b>Hi P1</b>                  Hi P1 imposta il limite di allarme scarico alta pressione della pompa.                  Intervallo: variabile a seconda della pompa                  Impostazione predefinita dalla fabbrica: variabile a seconda della pompa</p> <ul style="list-style-type: none"> <li>• Premiere </li> <li>• Il display lampeggerà tra Hi P1 e il valore predefinito</li> <li>• Se desiderato, utilizzare  per regolare il valore</li> <li>• Premiere </li> </ul>	<p><b>13</b> <b>dELAY</b>                  dELAY è il tempo ammesso oltre il limite di allarme Hi P1 prima che la pompa venga spenta.                  Intervallo: variabile a seconda della pompa                  Impostazione predefinita dalla fabbrica: 0 secondi</p> <ul style="list-style-type: none"> <li>• Il display lampeggerà tra dELAY e 0</li> <li>• Se desiderato, utilizzare  per regolare il valore</li> <li>• Premiere </li> <li>• NOTA Questa funzione è attiva solo se il refrigeratore è configurato per spegnersi, vedere il passo 16.</li> </ul>	<p><b>14</b> <b>Lo P1</b>                  Lo P1 imposta il limite di allarme scarico bassa pressione della pompa.                  Intervallo: variabile a seconda della pompa                  Impostazione predefinita dalla fabbrica: variabile a seconda della pompa</p> <ul style="list-style-type: none"> <li>• Premiere </li> <li>• Il display lampeggerà tra Lo P1 e il valore predefinito</li> <li>• Se desiderato, utilizzare  per regolare il valore</li> <li>• Premiere </li> </ul>	<p><b>15</b> <b>dELAY</b>                  dELAY è il tempo ammesso oltre il limite di allarme Lo P1 prima che la pompa venga spenta.                  Intervallo: da 0 a 30 secondi                  Impostazione predefinita dalla fabbrica: 10 secondi</p> <ul style="list-style-type: none"> <li>• Il display lampeggerà tra dELAY e 10</li> <li>• Se desiderato, utilizzare  per regolare il valore</li> <li>• Premiere </li> <li>• NOTA Questa funzione è attiva solo se il refrigeratore è configurato per spegnersi, vedere il passo 16.</li> </ul>	<p><b>16</b> <b>ALr</b>                  ALr configura la reazione del refrigeratore ai limiti di allarme temperatura, pressione e flusso (opzionale) - sia spegnimento (FL) che funzionamento normale (INDC). Per ulteriori informazioni, vedere la sezione 4 nel manuale.                  Intervallo: "FL" o "INDC"                  Impostazione predefinita dalla fabbrica: FL</p> <ul style="list-style-type: none"> <li>• Premiere </li> <li>• Il display lampeggerà tra ALr e FL</li> <li>• Se desiderato, premiere  per visualizzare INDC</li> <li>• Premiere </li> <li>• *FL = guasto (spegnimento)</li> <li>• **INDC = segnalazione (funzionamento normale)</li> </ul>	<p><b>17</b> <b>Sound</b>                  Attiva o disattiva l'allarme acustico del refrigeratore.                  Intervallo: on o OFF                  Impostazione predefinita dalla fabbrica: On</p> <ul style="list-style-type: none"> <li>• Premiere </li> <li>• Il display lampeggerà tra Sound e on</li> <li>• Se desiderato, premiere  per visualizzare OFF</li> <li>• Premiere </li> </ul>	<p><b>18</b> <b>StArT</b>                  StArT attivadisattiva il riavvio automatico.                  Intervallo: on o OFF                  Impostazione predefinita dalla fabbrica: OFF</p> <ul style="list-style-type: none"> <li>• Premiere </li> <li>• Il display lampeggerà tra StArT e OFF</li> <li>• Se desiderato, premiere  per visualizzare ON</li> <li>• Premiere </li> </ul>	<p><b>19</b> <b>CARe</b>                  CARe viene utilizzato per impostare il promemoria di frequenza manutenzione preventiva di pulizia per i filtri aria e liquido del refrigeratore.                  Intervallo: off, L1 - 1000 hours, L2 - 2000 hours, L3 - 3000 hours                  Impostazione predefinita dalla fabbrica: L1</p> <ul style="list-style-type: none"> <li>• Premiere </li> <li>• Il display lampeggerà tra CARe e L1</li> <li>• Se desiderato, utilizzare  per cambiare la modalità del display in off, L2 o L3</li> <li>• Premiere </li> </ul>	<p><b>20</b> <b>SP</b>                  SP viene utilizzato per regolare il valore di impostazione.                  Intervallo: da +5°C a +49°C                  Impostazione predefinita dalla fabbrica: +20°C</p> <ul style="list-style-type: none"> <li>• Il display lampeggerà tra SP e 20</li> <li>• Se desiderato, utilizzare  per modificare l'impostazione</li> <li>• Premiere  per salvare il nuovo valore di impostazione e tornare alla visualizzazione della temperatura.</li> </ul>
---	---	---	---	---	--	---	---	--	---	--	---

**Se applicabile, vedere i riquadri a destra per impostare le opzioni. Per i refrigeratori con I/O analogico (ACOM), fare riferimento alla guida di avvio rapido aggiuntiva fornita con il refrigeratore.**

<p><b>20</b> <b>StORe</b>                  Premiere  per salvare tutte le impostazioni                  Il refrigeratore viene avviato automaticamente.                  Premiere  per ignorare tutte le modifiche e ripristinare i valori predefiniti della fabbrica.                  Il display si spegnerà.                  Se desiderato, premiere  per riattivare la procedura.</p>	<p>A questo punto la procedura di configurazione è completata.                  All'avvio del refrigeratore, sul controller viene visualizzata la temperatura del liquido di processo.                  Se desiderato, è possibile modificare/ripristinare il valore di impostazione del refrigeratore premendo <b>mode</b></p>	<p><b>H</b> <b>PAR</b>                  PAR viene utilizzato come strumento di controllo per gli errori di comunicazione.                  Intervallo: even, odd o none                  Impostazione predefinita dalla fabbrica: none</p> <ul style="list-style-type: none"> <li>• Premiere </li> <li>• Il display lampeggerà tra PAR e none</li> <li>• Se desiderato, utilizzare  per modificare l'impostazione</li> <li>• Premiere </li> </ul>
--	---	---

**Opzione - Tensione — Passo A**

**A** **HZ**  
 HZ viene utilizzato per identificare la frequenza in entrata per i refrigeratori con pompe P3 - P5 e la capacità di funzionamento a 50 Hz o 60 Hz. La frequenza selezionata regola automaticamente l'impostazione predefinita dell'alta pressione fissa del firmware.  
 Intervallo: 50 Hz o 60 Hz  
 Impostazione predefinita dalla fabbrica: 60 Hz

- Premiere
- Il display lampeggerà tra HZ e 60
- Se necessario, utilizzare per cambiare frequenza
- Premiere
- Se il refrigeratore non dispone di un trasduttore di flusso o di comunicazioni seriali, vedere il passo 20.

**Opzione - Trasduttore di flusso — Passi B e C**

**B** **Hi FLO**  
 HiFLO imposta il limite di allarme flusso elevato.  
 Intervallo: variabile a seconda della pompa  
 Impostazione predefinita dalla fabbrica: variabile a seconda della pompa

- Premiere
- Il display lampeggerà tra HiFLO e il valore predefinito
- Se desiderato, utilizzare per regolare il valore
- Premiere

**C** **Lo FLO**  
 LoFLO imposta il limite di allarme flusso basso.  
 Intervallo: variabile a seconda della pompa  
 Impostazione predefinita dalla fabbrica: variabile a seconda della pompa

- Premiere
- Il display lampeggerà tra LoFLO e il valore predefinito
- Se desiderato, utilizzare per regolare il valore
- Premiere
- Se il refrigeratore non dispone di comunicazioni seriali, vedere il passo 20.

**Opzione - Comunicazioni seriali (DCOM) — Passi da D a I**

**D** **SEr**  
 SEr viene utilizzato per attivare/disattivare e per configurare la modalità di comunicazione seriale.  
 Intervallo: off, RS232, RS485  
 Impostazione predefinita dalla fabbrica: off

- Premiere
- Il display lampeggerà tra SEr e OFF
- Se desiderato, utilizzare per modificare la modalità
- Premiere

**E** **BAud**  
 BAud viene utilizzato per selezionare la velocità di trasmissione in baud per le comunicazioni seriali.  
 Intervallo: 9600, 4800, 2400, 1200, 600 o 300 bit al secondo.

- Premiere
- Il display lampeggerà tra BAud e 9600
- Se desiderato, utilizzare per modificare la velocità
- Premiere

**F** **dAtA**  
 dAtA viene utilizzato per visualizzare il numero di bit.  
 Display: 8

- Premiere
- Il display lampeggerà tra dAtA e 8
- Premiere

**G** **StOp**  
 StOp viene utilizzato per indicare il numero di bit di arresto.  
 Intervallo: 2 o 1  
 Impostazione predefinita dalla fabbrica: 1

- Premiere
- Il display lampeggerà tra StOp e 1
- Se desiderato, utilizzare per modificare l'impostazione
- Premiere

**I** **uId**  
 uId (ID unità) viene utilizzato solo in RS485. Indica i dispositivi collegati alla porta RS485.  
 Intervallo: da 1 a 99  
 Impostazione predefinita dalla fabbrica: 1

- Premiere
- Il display lampeggerà tra uId e 1
- Se desiderato, utilizzare per modificare l'impostazione
- Premiere

**Vedere il passo 20.**





**Esta guía de puesta en marcha rápida se ha elaborado únicamente para el arranque inicial. Para obtener información sobre otros procedimientos, debe consultar el manual. Asimismo, en caso de que tuviera dudas sobre alguno de estos pasos, descargue el manual antes de continuar.**

**Seguridad:**

- El enfriador está destinado exclusivamente para uso en interiores. No lo coloque nunca en lugares con calor o humedad excesivos, ventilación inadecuada o presencia de materiales corrosivos.
- Conecte el enfriador a una toma de tierra adecuada.
- Los refrigerantes utilizados son más pesados que el aire, por lo que sustituirán al oxígeno y provocarán la pérdida del conocimiento. En caso de que entre en contacto con el refrigerante procedente de fugas, se producirán quemaduras en la piel. Consulte la placa identificativa del enfriador y la hoja de datos de seguridad de materiales (MSDS) más actual del fabricante.
- Mueva el enfriador con cuidado. Los saltos repentinos o las caídas pueden dañar sus componentes. Apague siempre el equipo y desconecte de la tensión eléctrica antes de moverlo.
- Nunca ponga en funcionamiento un equipo que esté dañado o que presente fugas.



Figura A



Figura B

- Si la unidad está provista de una bomba de desplazamiento positivo (P1 o P2), asegúrese de que los tubos y conectores de su aplicación tienen capacidad para soportar un mínimo de 185 psi.
- No utilice ningún cartucho de filtro de desionización (DI) con EG inhibido o PG inhibido. Los filtros de DI eliminarán los inhibidores de la solución, lo que provocará que el líquido no ofrezca protección frente a la corrosión. Asimismo, los inhibidores incrementarán la conductividad de los líquidos.
- Utilice únicamente los líquidos aprobados que se muestran en la Tabla 1. Antes de utilizar líquidos o realizar tareas de mantenimiento en las que pueda entrar en contacto con ellos, consulte las precauciones de manipulación en las hojas de datos de seguridad de materiales (MSDS) del fabricante.
- Para evitar que el intercambiador de placas se congele o acristale, los enfriadores ThermoFlex7500-24000 requieren el uso de EG/agua de 50/50 o de PG/agua de 50/50 por debajo de una temperatura de proceso de 10 °C.

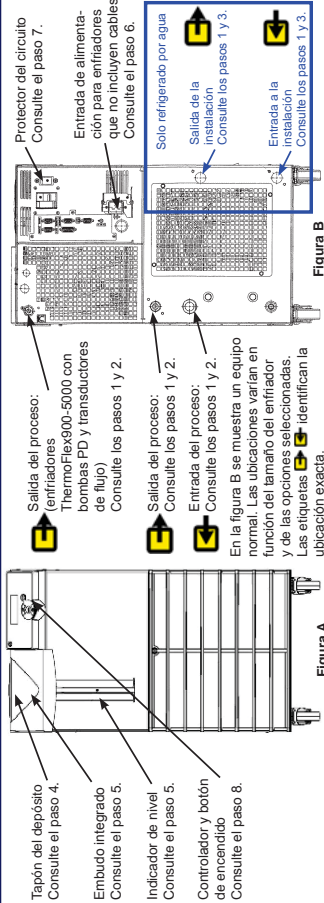
**Materiales necesarios:**

- Una llave inglesa ajustable
- Instalaciones para el suministro y el retorno del agua (enfriadores refrigerados por agua)
- Manguera o tuberías apropiadas
- Abrazaderas o conexiones con el tamaño adecuado
- Cinta de Teflón® o un sellador adecuado

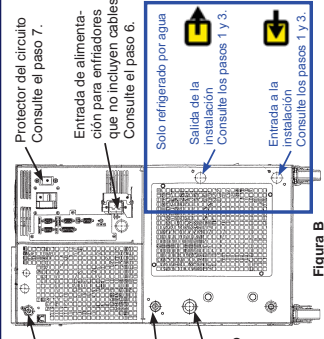
**Conexiones para agua de la instalación (FNPT)**

ThermoFlex1400 - 5000 entrada/salida, bronce fundido, 0,5 pulg  
 ThermoFlex7500 - 10.000 entrada/salida, bronce fundido, 0,75 pulg  
 ThermoFlex15000 - 24.000 entrada, bronce fundido, 0,75 pulg  
 ThermoFlex15000 - 24.000 salida, acero inoxidable, 0,75 pulg

**Conexiones de los líquidos de proceso (FNPT)**

Salida  
 P1 P2 T0 T1 Bronce fundido, 0,5 pulg  
 P3 P4 Bronce fundido, 0,75 pulg  
 P3 P5 T5 Cobre forjado, 1 pulg  
 Entrada: tamaño idéntico al de la salida de todos los enfriadores de acero inoxidable  
 Adaptadores suministrados  
 P1 P2 T0 T1 Polietileno de 0,5 pulg x 0,375 pulg y nailon de 0,5 pulg x 0,5 pulg  
 P3 P4 MPT de 0,75 pulg x conector de PVC de 0,5 pulg  
 P3 P5 T5 MPT de 1 pulg x conector de PVC de 1 pulg y MPT de 1 pulg x conector de PVC de 0,75 pulg

**Tabla 1: Líquidos aprobados**

El uso de cualquier otro líquido anula la garantía del cliente.

Enfriadores de temperatura estándar	
Agua filtrada/desilada (pH 7 - 8)	
Agua desionizada (1 - 3 MΩ-cm, compensada)	
Agua desilada con inhibidor y bicicla Nalco	
Agua desilada con cloro (5 ppm)	
Agua/eitenglicol para laboratorio al 0 - 75 %	
Agua/propienglicol para laboratorio al 0 - 75 %	

**1** Retire los plásticos de embalaje de los enchufes (2 o 4).

Las ubicaciones varían en función del tamaño del enfriador y de las opciones seleccionadas. Las etiquetas identifican la ubicación exacta.

Solo refrigerado por agua

Salida de proceso

Entrada de proceso

Salida de la instalación

Entrada a la instalación

Consulte la Figura B.

**5** Si se suministra, coloque en posición vertical el disyuntor GFCI que se ubica en la parte posterior. Para los enfriadores ThermoFlex900 hasta 10.000, coloque el protector del circuito en la posición de encendido (I). En la pantalla del controlador aparecerá una serie de barras de desplazamiento (▬). Las barras se desplazarán hacia arriba, indicando que el enfriador se está inicializando. Este proceso dura 15 segundos aproximadamente. En otros enfriadores, las barras aparecen cuando el enfriador recibe alimentación eléctrica.

El protector del circuito no se ha diseñado para utilizarse como un medio de desconexión.

Consulte la Figura B.

**2** Conecte la SALIDA DE PROCESO de ThermoFlex (A) a la entrada de líquidos de su aplicación. Conecte la ENTRADA DE PROCESO de ThermoFlex (B) a la salida de líquidos de su aplicación. Asegúrese de que las conexiones se han cerrado y fijado correctamente. Para los enfriadores refrigerados por aire, continúe con el paso 4.

No conecte nunca tubos con líquido de proceso al suministro de agua del centro ni a ninguna fuente de líquido presurizado.

Salida de proceso

Entrada de proceso

Salida de la instalación

Entrada a la instalación

Consulte la Figura B.

**6** Nunca ponga en marcha el chiller sin líquido refrigerante en el tanque o sin la bolsa de filtro instalada.

Tire con cuidado la carcasa de plástico del embudo para quitarla e instalar la bolsa de filtro suministrada. Reinstalar de nuevo la carcasa.

Consulte la Figura A.

**3** Conecte la SALIDA DE LA INSTALACIÓN de ThermoFlex (A) a un desagüe o conducto de retorno de agua a la instalación. Conecte la ENTRADA A LA INSTALACIÓN de ThermoFlex (B) a un suministro de agua. Asegúrese de que las conexiones se han cerrado y fijado correctamente.

Solo para equipos refrigerados por agua.

La presión máxima de entrada del agua en la instalación no debe exceder los 150 PSIG. El diferencial de la presión máxima del agua en la instalación no debe exceder los 50 PSID.

Salida de la instalación

Entrada a la instalación

Consulte la Figura B.

**7** Lentamente rellene el depósito con líquido de proceso limpio (consulte la tabla 1). Utilice el tubo de control de nivel para controlar con facilidad el nivel de líquido. Cuando el depósito esté lleno, vuelva a colocar el tapón del depósito y apriételo a mano. Ya que la capacidad del depósito puede ser pequeña para la aplicación de que se trate y posiblemente deba purgar el aire de los tubos, tenga a mano líquido extra para mantener el sistema lleno al máximo cuando se inicie la circulación externa.

Nota: Tenga cuidado de no rellenar el depósito por encima de la línea de NIVEL MÁXIMO de llenado. De lo contrario, generará un error de desbordamiento en la unidad (O FLO) que hará que el enfriador se apague.

Consulte la Figura A.

**4** Consulte la placa identificativa de la parte posterior del enfriador y compruebe la tensión apropiada. Para los enfriadores que se suministran con un cable de alimentación, inserte el extremo hembra del cable de alimentación en el enfriador y a continuación, inserte el extremo macho del cable de alimentación en la toma eléctrica (el cable de alimentación se ubica debajo de la tapa de la caja de transporte. No deseché la tapa hasta que haya encontrado el cable).

En caso de que el cable de alimentación esté dañado, no utilice el enfriador.

Nota: Los enfriadores ThermoFlex900-5000 que se suministran con la opción de tensión variable de tensión global disponen de un panel de configuración de la tensión. Consulte la hoja de instrucciones sobre tensión suministrada con el enfriador o consulte el apéndice B del manual.

Nota: Para obtener información sobre los enfriadores que requieren conectarse mediante cables, consulte la sección 3 del manual.

Consulte la Figura B.

**8** Pulse .

En el controlador se mostrará Setup (CONFIGURACIÓN).

Nota: Si el enfriador se suministra con un cartucho de filtro de desionización, consulte la sección 5 del manual para su instalación.

Para conocer los pasos adicionales, consulte el dorso.

Consulte la Figura A.

**Puesta en marcha rápida - Utilizar solo para el arranque inicial (realizar los pasos 9 a 20 con todos los enfriadores)**

<p><b>9 Un i t S</b></p> <p>UnitS hace referencia a las escalas de temperatura, flujo de líquidos (opcional) y presión.</p> <p>Escalas: °C/F GPM/LPM (gal/min o l/min) P/SiBar/KPAS</p> <ul style="list-style-type: none"> <li>• Pulse  para pasar a la siguiente pantalla.</li> <li>• La pantalla parpadeará alternando entre Units y °C.</li> <li>• Si lo desea, utilice  para cambiar la escala a °F.</li> <li>• Pulse  para pasar a la siguiente pantalla.</li> <li>• Realice la misma acción con las escalas de flujo y presión.</li> </ul>	<p><b>10 Hi t</b></p> <p>Hi t permite establecer el límite superior de alarma de temperatura del líquido.</p> <p>Intervalo: de + 3 °C a + 42 °C</p> <p>Valor predeterminado de fábrica: + 42 °C</p> <ul style="list-style-type: none"> <li>• Pulse  para pasar a la siguiente pantalla.</li> <li>• La pantalla parpadeará alternando entre Hi t y 42.</li> <li>• Si lo desea, utilice  para ajustar el valor.</li> <li>• Pulse  para pasar a la siguiente pantalla.</li> </ul>	<p><b>11 Lo t</b></p> <p>Lo t permite establecer el límite inferior de alarma de temperatura.</p> <p>Intervalo: de + 3 °C a + 42 °C</p> <p>Valor predeterminado de fábrica: + 3 °C</p> <ul style="list-style-type: none"> <li>• Pulse  para pasar a la siguiente pantalla.</li> <li>• La pantalla parpadeará alternando entre Lo t y 3.</li> <li>• Si lo desea, utilice  para ajustar el valor.</li> <li>• Pulse  para pasar a la siguiente pantalla.</li> </ul>	<p><b>12 Hi Pi</b></p> <p>Hi Pi permite establecer el límite superior de alarma de descarga de presión de la bomba.</p> <p>Intervalo: según la bomba</p> <p>Valor predeterminado de fábrica: según la bomba</p> <ul style="list-style-type: none"> <li>• Pulse  para pasar a la siguiente pantalla.</li> <li>• La pantalla parpadeará alternando entre Hi Pi y el valor predeterminado.</li> <li>• Si lo desea, utilice  para ajustar el valor.</li> <li>• Pulse  para pasar a la siguiente pantalla.</li> </ul>	<p><b>13 dELAY</b></p> <p>dELAY hace referencia al periodo de tiempo durante el que la bomba puede superar el límite de alarma Hi Pi antes de apagarse.</p> <p>Intervalo: según la bomba</p> <p>Valor predeterminado de fábrica: 0 segundos</p> <ul style="list-style-type: none"> <li>• La pantalla parpadeará alternando entre dELAY y 0.</li> <li>• Si lo desea, utilice  para ajustar el valor.</li> <li>• Pulse  para pasar a la siguiente pantalla.</li> </ul> <p>NOTA: Esta función solo está activa si el enfriador está configurado para que se apague; consulte el paso 16.</p>	<p><b>14 Lo Pi</b></p> <p>Lo Pi permite establecer el límite inferior de alarma de descarga de presión de la bomba.</p> <p>Intervalo: según la bomba</p> <p>Valor predeterminado de fábrica: según la bomba</p> <ul style="list-style-type: none"> <li>• Pulse  para pasar a la siguiente pantalla.</li> <li>• La pantalla parpadeará alternando entre Lo Pi y el valor predeterminado.</li> <li>• Si lo desea, utilice  para ajustar el valor.</li> <li>• Pulse  para pasar a la siguiente pantalla.</li> </ul>	<p><b>15 dELAY</b></p> <p>dELAY hace referencia al periodo de tiempo durante el que la bomba puede superar el límite de alarma Lo Pi antes de apagarse.</p> <p>Intervalo: de 0 a 30 segundos</p> <p>Valor predeterminado de fábrica: 10 segundos</p> <ul style="list-style-type: none"> <li>• La pantalla parpadeará alternando entre dELAY y 10.</li> <li>• Si lo desea, utilice  para ajustar el valor.</li> <li>• Pulse  para pasar a la siguiente pantalla.</li> </ul> <p>NOTA: Esta función solo está activa si el enfriador está configurado para que se apague; consulte el paso 16.</p>	<p><b>16 ALr</b></p> <p>ALr permite configurar la reacción del enfriador a los límites de alarma de temperatura, presión y flujo (opcional); se apagará (FL) o continuará funcionando (IndC). Consulte la sección 4 del manual para obtener más información.</p> <p>Intervalo: fLr, o IndC**</p> <p>Valor predeterminado de fábrica: fLr</p> <ul style="list-style-type: none"> <li>• Pulse  para mostrar IndC.</li> <li>• Si lo desea, pulse  para mostrar IndC.</li> <li>• Si lo desea, pulse  para mostrar IndC.</li> <li>• Pulse  para mostrar IndC.</li> <li>• **IndC = indicación (continuar en funcionamiento)</li> </ul>	<p><b>17 Sound</b></p> <p>Permite activar o desactivar la alarma sonora del enfriador.</p> <p>Intervalo: ON u OFF</p> <p>Valor predeterminado de fábrica: ON</p> <ul style="list-style-type: none"> <li>• Pulse  para mostrar OFF.</li> <li>• La pantalla parpadeará alternando entre Sound y ON.</li> <li>• Si lo desea, pulse  para mostrar OFF.</li> <li>• Pulse  para mostrar OFF.</li> </ul>	<p><b>18 StAr t</b></p> <p>StAr t permite activar/desactivar el reinicio automático.</p> <p>Intervalo: ON u OFF</p> <p>Valor predeterminado de fábrica: OFF</p> <ul style="list-style-type: none"> <li>• Pulse  para mostrar ON.</li> <li>• La pantalla parpadeará alternando entre StAr t y OFF.</li> <li>• Si lo desea, pulse  para mostrar ON.</li> <li>• Pulse  para mostrar ON.</li> </ul>	<p><b>19 CArE</b></p> <p>CArE se utiliza para configurar el recordatorio que indica la frecuencia de limpieza como cuidado preventivo para los filtros de aire y líquidos del enfriador.</p> <p>Intervalo: OFF L1 - 1000 horas, L2 - 2000 horas, L3 - 3000 horas</p> <p>Valor predeterminado de fábrica: L1</p> <ul style="list-style-type: none"> <li>• Pulse  para cambiar la pantalla a OFF L2 o L3.</li> <li>• Si lo desea, utilice  para cambiar la pantalla a OFF L2 o L3.</li> <li>• Pulse  para cambiar la pantalla a OFF L2 o L3.</li> </ul>	<p><b>20 SP</b></p> <p>SP se utiliza para ajustar el valor de referencia.</p> <p>Intervalo: de + 5 °C a + 40 °C</p> <p>Valor predeterminado de fábrica: + 20 °C</p> <ul style="list-style-type: none"> <li>• La pantalla parpadeará alternando entre SP y 20.</li> <li>• Si lo desea, utilice  para cambiar el ajuste.</li> <li>• Pulse  para guardar el nuevo valor de referencia y volver a la pantalla de temperatura.</li> </ul>
--	--	--	--	---	--	---	--	---	---	---	--

**Si procede, consulte los cuadros situados a la derecha para configurar las opciones. En el caso de enfriadores con módulo de entrada/salida analógico (ACOM), consulte las instrucciones de puesta en marcha rápida adicionales suministradas con el equipo.**

<p><b>20 Store</b></p> <p>Ha completado el procedimiento de configuración.</p> <p>Al encender el enfriador, el controlador muestra la temperatura del líquido del proceso.</p> <p>Si lo desea, puede pulsar  para cambiar/ verificar el valor de referencia del enfriador.</p> <ul style="list-style-type: none"> <li>• Pulse  para guardar todos los ajustes.</li> <li>• Pulse  para rechazar todos los cambios y restaurar los valores predeterminados de fábrica.</li> <li>• La pantalla se quedará en blanco.</li> <li>• Si lo desea, pulse  para reiniciar el procedimiento.</li> </ul>	<p><b>20 Store</b></p> <p>Store se utiliza para guardar todos los ajustes.</p> <p>El enfriador se enciende automáticamente.</p> <ul style="list-style-type: none"> <li>• Pulse  para guardar todos los ajustes.</li> <li>• Pulse  para rechazar todos los cambios y restaurar los valores predeterminados de fábrica.</li> <li>• La pantalla se quedará en blanco.</li> <li>• Si lo desea, pulse  para reiniciar el procedimiento.</li> </ul>	<p><b>20 Store</b></p> <p>Store se utiliza para ajustar el valor de referencia.</p> <p>Intervalo: de + 5 °C a + 40 °C</p> <p>Valor predeterminado de fábrica: + 20 °C</p> <ul style="list-style-type: none"> <li>• La pantalla parpadeará alternando entre SP y 20.</li> <li>• Si lo desea, utilice  para cambiar el ajuste.</li> <li>• Pulse  para guardar el nuevo valor de referencia y volver a la pantalla de temperatura.</li> </ul>
--	---	--

**Opción - Tensión — Paso A**

**A HZ**

Hz se utiliza para identificar la frecuencia entrante en los enfriadores con bombas P3 - P5 y la capacidad de funcionar a 50 Hz o 60 Hz. La frecuencia seleccionada ajusta automáticamente la configuración predeterminada de presión alta fija del firmware.

Intervalo: 50 Hz o 60 Hz

Valor predeterminado de fábrica: 60 Hz

- Pulse .
- La pantalla parpadeará alternando entre HZ y 60.
- Si es necesario, utilice para cambiar la frecuencia.
- Pulse .

Si el enfriador no dispone de transductor de flujo o no admite comunicaciones en serie, consulte el paso 20.

**Opción - Transductor de flujo — Pasos B y C**

**B Hi FLo**

HiFLO permite establecer el límite superior de alarma de flujo.

Intervalo: según la bomba

Valor predeterminado de fábrica: según la bomba

- Pulse .
- La pantalla parpadeará alternando entre HiFLO y el valor predeterminado.
- Si lo desea, utilice para ajustar el valor.
- Pulse .

**C Lo FLo**

LoFLO permite establecer el límite inferior de alarma de flujo.

Intervalo: según la bomba

Valor predeterminado de fábrica: según la bomba

- Pulse .
- La pantalla parpadeará alternando entre LoFLO y el valor predeterminado.
- Si lo desea, utilice para ajustar el valor.
- Pulse .

Si el enfriador no admite comunicaciones en serie, consulte el paso 20.

**Opción - Comunicaciones en serie (DCOM) — Pasos D a I**

**D SEr**

SEr se utiliza para activar/desactivar y configurar el modo de comunicaciones en serie.

Intervalo: OFF rS232, rS485

Valor predeterminado de fábrica: OFF

- Pulse .
- La pantalla parpadeará alternando entre SEr y OFF.
- Si lo desea, utilice para cambiar el modo.
- Pulse .

**E BAud**

BAud se utiliza para seleccionar la velocidad en baudios para la comunicación en serie.

Intervalo: 9600, 4800, 2400, 1200, 600 o 300 bits por segundo.

- Pulse .
- La pantalla parpadeará alternando entre BAud y 9600.
- Si lo desea, utilice para cambiar la velocidad.
- Pulse .

**F dAtA**

dAtA se utiliza para mostrar el número de bits.

Pantalla: 8

- Pulse .
- La pantalla parpadeará alternando entre dAtA y 8.
- Pulse .

**G StOp**

StOp se utiliza para indicar el número de bits de parada.

Intervalo: 2 o 1

Valor predeterminado de fábrica: 1

- Pulse .
- La pantalla parpadeará alternando entre StOp y 1.
- Si lo desea, utilice para cambiar el ajuste.
- Pulse .

**H PAr**

PAr se utiliza como medio para comprobar si hay errores de comunicación.

Intervalo: even, odd o none

Valor predeterminado de fábrica: none

- Pulse .
- La pantalla parpadeará alternando entre PAr y none.
- Si lo desea, utilice para cambiar el ajuste.
- Pulse .

**I u id**

u id (ID de unidad) se utiliza solo en RS485. Permite identificar los dispositivos conectados al puerto RS485.

Intervalo: de 1 a 99

Valor predeterminado de fábrica: 1

- Pulse .
- La pantalla parpadeará alternando entre u id y 1.
- Si lo desea, utilice para cambiar el ajuste.
- Pulse .

Consulte el paso 20.



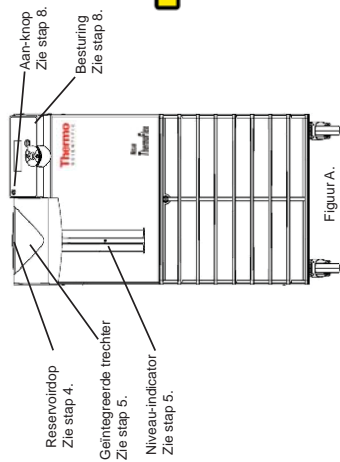

Figuur A.

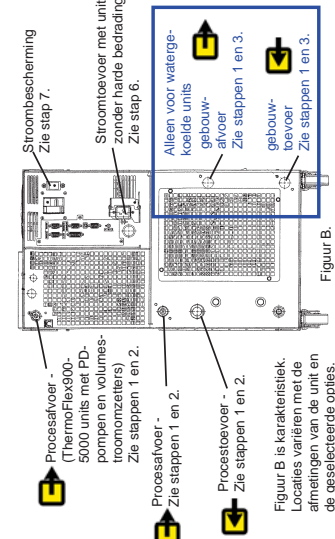

Figuur B.

- Dit heeft u nodig om te kunnen beginnen:**
- Een verstelbare steeksleutel
  - Watervoer en terugvoer op de locatie (watergekoelde units)
  - Een geschikte slang of leiding
  - Klemmen van de juiste grootte of type aansluiting
  - Teflon® Tape of een geschikte afsluiting

**Aansluitingen Process/voelstof (FNPT)**

Alvoer

ThermoFlex900 - 10000 P1 P2 T0 T1 1/2" gietbrons  
 ThermoFlex3500 - 5000 P3 P4 3/4" gietbrons  
 ThermoFlex7500 - 24000 P3 P5 T5 1" gesmeed koper

Toevoer - Zelfde maat als alvoer alle units roestvrij staal

**Wateraansluitingen locatie (FNPT)**

ThermoFlex1400 - 5000 Toevoer/Alvoer 1/2" gietbrons  
 ThermoFlex7500 - 10000 Toevoer/Alvoer 3/4" gietbrons  
 ThermoFlex15000 - 24000 Toevoer 3/4" gietbrons  
 ThermoFlex15000 - 24000 Alvoer 3/4" roestvrij staal

<p><b>1</b> Trek de plastic transportpluggen eruit.</p> <p>Alleen voor watergekoelde units</p> <p>PROCES AFVOER</p> <p>PROCES TOEVOER</p> <p>Zie figuur B.</p>	<p><b>2</b> Sluit de ThermoFlex PROCESAFVOER (A) aan op de vloeistoftoevoer op uw toepassing. Sluit de ThermoFlex PROCESAFVOER (B) aan op de vloeistofafvoer op uw toepassing. Zorg ervoor dat de verbindingen afgesloten zijn en goed vastzitten.</p> <p><b>Ga voor luchtgekoelde units door naar stap 4.</b></p> <p>Alleen voor watergekoelde units</p> <p>PROCES AFVOER</p> <p>PROCES TOEVOER</p> <p>Zie figuur B.</p>	<p><b>3</b> Sluit de ThermoFlex FACILITY-OUTLET (A) aan op de wateringvoer of -afvoer van uw gebouw. Sluit de ThermoFlex FACILITY-INLET (B) aan op de watervoorziening van uw gebouw. Zorg ervoor dat de verbindingen afgesloten zijn en goed vastzitten.</p> <p>Alleen voor watergekoelde units.</p> <p>Zie figuur B.</p>	<p><b>4</b> De doorstroomkoeler mag nooit operationeel zijn zonder dat er de juiste vloeistof in het reservoir zit of zonder dat het vloeistoffilter geïnstalleerd is.</p> <p>Maak het plastic vulkappje los door het omhoog te tillen en installeer dan het meegeleverde vloeistoffilter. Plaats daarna het plastic vulkappje terug.</p> <p>Zie figuur A.</p>
<p><b>5</b> Vul het reservoir langzaam met schone procesvloeistof (zie tabel 1) met gebruik van het kibbuisje voor het gemakkelijk in de gaten houden van het vloeistofniveau. Plaats als het reservoir vol is de dop er weer op, handvast. Aanpassen de capaciteit van het reservoir klein kan zijn in vergelijking tot uw toepassing en het nodig kan zijn dat er lucht uit de leidingen geborgen moet worden, dient u extra koelvloeistof bij de hand te houden om het systeem bijgevuld te houden als de uitwendige circulatie wordt gestopt.</p> <p><b>Let op:</b> Let goed op dat het reservoir niet boven de lijn MAX NIVEAU wordt gevuld. Dit zal leiden tot een overflowsfout (O FLO) van de unit waardoor de unit zal uitschakelen.</p> <p>Zie figuur A.</p>	<p><b>6</b> Controleer de juiste spanning. Voor units die worden geleverd met een reïsonor, steek de vrouwelijke kant van de stroomkabel in de koeler en steek de mannelijke kant van de stroomkabel in de voedingsofuitgang. (Het reïsonor bevindt zich onder de deksel van de reïsonorhuis. Gooi het deksel niet weg voordat u het reïsonor heeft gevonden).</p> <p><b>Let op:</b> ThermoFlex900-5000 units uitgerust met de optie Variabele spanning of Universele spanning hebben een configuratiepaneel voor de spanning achter een inspectieluik aan de achterkant van de unit. Raadpleeg het instructieblad Spanning dat bij de unit is geleverd, of zie Appendix B van de handleiding.</p> <p><b>Let op:</b> Raadpleeg voor units die harde bedrading nodig hebben hoofdstuk 3 in de handleiding.</p> <p>Zie figuur B.</p>	<p><b>7</b> Zet de stroombeschermer op de aan(I)-stand. Het besturingsdisplay zal een reeks schuifbalken (I) laten zien. De balken schuiven naar boven, wat aangeeft dat de unit aan het initialiseren is. Dit duurt ongeveer 15 seconden.</p> <p>Zie figuur B.</p>	<p><b>8</b> Druk op . De besturing geeft SEtUp weer.</p> <p><b>Let op:</b> Als de unit is uitgerust met een deionisatiefiltercassette, raadpleeg dan de handleiding hoofdstuk 5, voor de installatie ervan.</p> <p><b>Zie de achterkant voor extra stappen.</b></p> <p>Zie figuur A.</p>

**Veiligheidsmaatregelen:**

- De unit is alleen ontworpen voor gebruik binnenhuis.
- Plaats een unit nooit op een plek met overmatige warmte, vocht, onvoldoende ventilatie of corrosieve materialen.
- Sluit nooit procesvloeistofleidingen aan op de watervoorziening van uw locatie of andere vloeistofbronnen onder druk.
- Als uw unit is uitgerust met een PD pomp, zorg er dan voor dat de leidingen en aansluitingen van uw toepassing geschikt zijn voor minimaal 185 psi.
- Raadpleeg voordat u vloeistoffen gebruikt of onderhoud uitvoert op plekken waar waarschijnlijk contact is met vloeistof, de veiligheidsbladen van de fabrikant voor voorzorgsmaatregelen.

**Tabel 1 - Toegestane vloeistoffen:**

Door gebruik van vloeistoffen die niet hieronder worden vermeld komt de fabrieksgarantie te vervallen.

Gefiltreerd/enkelvoudig gedestilleerd water

Gedioniseerd water (1-3 MQ-cm, gecompenseerd)

0 - 75% Ethyleenglycol/water

0 - 75% Propyleenglycol/water

**Quick Start - Alleen gebruikt voor het initieel opstarten - voer de stappen 9 tot 20 uit voor alle units.**

<p>Let op: Sommige bereiken/standaardwaarden zijn afhankelijk van de pomp, zie hoofdstuk 4 in de handleiding. Als een Setup-step eenmaal is voltooid, wat betekent dat u de <b>enter</b> toets een tweede maal hebt ingedrukt, kunt u de stap niet meer herhalen om correcties aan te brengen. U kunt wijzigingen doorvoeren nadat de unit is gestart.</p> <p><b>Setup</b>   Druk op <b>enter</b> om naar de setupprocedure te gaan.</p>	<p><b>9 Unit</b> zijn de schalen voor temperatuur, flow van de vloeistof (optioneel) en druk.          Schalen: °C/F GPMLPM          PSI/Bar/KPAS          Fabrieeksstandaard: °C, Gallons, PSI</p> <ul style="list-style-type: none"> <li>Druk op <b>enter</b></li> <li>Het display zal knipperen tussen Units en °C.</li> <li>Gebruik, indien gewenst,  om de schaal in °F te veranderen</li> <li>Druk op <b>enter</b> om naar het volgende display te gaan</li> <li>Doet hetzelfde voor de schalen voor Flow en druk</li> </ul>	<p><b>10 Hi</b> is de Alarmlimiet voor hoge temperatuur voor de vloeistof worden ingesteld.          Bereik: +3°C tot +42°C          Fabrieeksstandaard: +42°C</p> <ul style="list-style-type: none"> <li>Druk op <b>enter</b></li> <li>Het display zal knipperen tussen Hi t en 42</li> <li>Gebruik, indien gewenst,  om de waarde aan te passen</li> <li>Druk op <b>enter</b> om naar het volgende display te gaan</li> </ul>	<p><b>Optie - Universele spanning - Stap A</b></p> <p><b>A HZ</b></p> <ul style="list-style-type: none"> <li>Druk op <b>enter</b></li> <li>Het display zal knipperen tussen HZ en 60</li> <li>Gebruik, indien nodig,  om de frequentie te wijzigen</li> <li>Druk op <b>enter</b> om naar de volumestroomomzetter of seriële communicatie heeft, zie stap 20.</li> </ul>
<p><b>11 Lo</b> t wordt de onderste alarmlimiet voor de temperatuur van de vloeistof ingesteld.          Bereik: +3°C tot +42°C</p> <ul style="list-style-type: none"> <li>Druk op <b>enter</b></li> <li>Het display zal knipperen tussen Lo t en 3</li> <li>Gebruik, indien gewenst,  om de waarde aan te passen</li> <li>Druk op <b>enter</b></li> </ul>	<p><b>12 Hi</b> Pi wordt de bovenste alarmlimiet voor drukvoer van de pomp ingesteld.          Bereik: Verschildt per pomp          Fabrieeksstandaard: Verschildt per pomp</p> <ul style="list-style-type: none"> <li>Druk op <b>enter</b></li> <li>Het display zal knipperen tussen Hi P1 en de standaardwaarde</li> <li>Gebruik, indien gewenst,  om de waarde aan te passen</li> <li>Druk op <b>enter</b></li> </ul>	<p><b>13 dELAY</b> is de tijdsduur dat de pomp de Hi P1 Alarmlimiet kan overschrijden voor hij uitschakelt.          Bereik: Verschildt per pomp          Fabrieeksstandaard: 0 seconden</p> <ul style="list-style-type: none"> <li>Het display zal knipperen tussen dELAY en 0</li> <li>Gebruik, indien gewenst,  om de waarde aan te passen</li> <li>Druk op <b>enter</b></li> <li>LET OP Deze functie is alleen actief als de unit geconfigureerd is om uit te schakelen, zie stap 16.</li> </ul>	<p><b>Optie - Volumestroomomzetter - Stappen B en C</b></p> <p><b>B Hi</b> FLo wordt de bovenste alarmlimiet voor de flow ingesteld.          Bereik: Verschildt per pomp          Fabrieeksstandaard: Verschildt per pomp</p> <ul style="list-style-type: none"> <li>Druk op <b>enter</b></li> <li>Het display zal knipperen tussen Hi FLO en de standaardwaarde</li> <li>Gebruik, indien gewenst,  om de waarde aan te passen</li> <li>Druk op <b>enter</b></li> </ul> <p><b>C Lo</b> FLo wordt de onderste alarmlimiet voor de flow ingesteld.          Bereik: Verschildt per pomp          Fabrieeksstandaard: Verschildt per pomp</p> <ul style="list-style-type: none"> <li>Druk op <b>enter</b></li> <li>Het display zal knipperen tussen Lo FLO en de standaardwaarde</li> <li>Gebruik, indien gewenst,  om de waarde aan te passen</li> <li>Druk op <b>enter</b></li> </ul>
<p><b>14 Lo</b> Pi wordt de onderste alarmlimiet voor drukvoer van de pomp ingesteld.          Bereik: Verschildt per pomp          Fabrieeksstandaard: Verschildt per pomp</p> <ul style="list-style-type: none"> <li>Druk op <b>enter</b></li> <li>Het display zal knipperen tussen Lo P1 en de standaardwaarde</li> <li>Gebruik, indien gewenst,  om de standaardwaarde aan te passen</li> <li>Druk op <b>enter</b></li> </ul>	<p><b>15 dELAY</b> is de tijdsduur dat de pomp de Lo P1 kan overschrijden Alarmlimiet voordat het uitschakelen plaatsvindt.          Bereik: 0 tot 30 seconden          Fabrieeksstandaard: 10 seconden</p> <ul style="list-style-type: none"> <li>Het display zal knipperen tussen dELAY en 10</li> <li>Gebruik, indien gewenst,  om de waarde aan te passen</li> <li>Druk op <b>enter</b></li> <li>LET OP Deze functie is alleen actief als de unit geconfigureerd is om uit te schakelen, zie stap 16.</li> </ul>	<p><b>16 ALr</b> configureert de reactie van de unit op alarmlimieten voor temperatuur, druk en flow (optioneel) - ofwel uitschakelen (fL) of in werking blijven (indC). Zie Hoofdstuk 4 van de handleiding voor meer informatie.          Bereik: fL* of indC**          Fabrieeksstandaard: fL</p> <ul style="list-style-type: none"> <li>Druk op <b>enter</b></li> <li>Het display zal knipperen tussen ALr en fL</li> <li>Druk, indien gewenst, op  om indC weer te geven</li> <li>Druk op <b>enter</b></li> <li>*fL = fault (uitschakelen)</li> <li>**indC = indicate (in werking blijven)</li> </ul>	<p><b>Optie - Seriële communicatie (DCOM) - Stappen D tot I</b></p> <p><b>D SER</b> wordt gebruikt voor het inschakelen/uitschakelen en configureren van de seriële-communicatiemodus          Bereik: uit, rS232, rS485          Fabrieeksstandaard: uit</p> <ul style="list-style-type: none"> <li>Druk op <b>enter</b></li> <li>Het display zal knipperen tussen SER en UIT</li> <li>Indien gewenst kunt u  gebruiken om de modus te wijzigen</li> <li>Druk op <b>enter</b></li> </ul> <p><b>E BAud</b> wordt gebruikt om de baudrate (snelheid) voor seriële communicatie te kiezen.          Bereik: 9600, 4800, 2400, 1200, 600 of 300 bits per seconde.</p> <ul style="list-style-type: none"> <li>Druk op <b>enter</b></li> <li>Het display zal knipperen tussen BAud en 9600</li> <li>Indien gewenst kunt u  gebruiken om de snelheid te wijzigen</li> <li>Druk op <b>enter</b></li> </ul> <p><b>F dATA</b> wordt gebruikt om het aantal bits weer te geven.          Display: 8</p> <ul style="list-style-type: none"> <li>Druk op <b>enter</b></li> <li>Het display zal knipperen tussen dATA en 8</li> <li>Druk op <b>enter</b></li> </ul> <p><b>G StOp</b> wordt gebruikt om het aantal stopbits aan te geven.          Bereik: 2 of 1          Fabrieeksstandaard: 1</p> <ul style="list-style-type: none"> <li>Druk op <b>enter</b></li> <li>Het display zal knipperen tussen StOp en 1</li> <li>Indien gewenst kunt u  gebruiken om de instelling te wijzigen</li> <li>Druk op <b>enter</b></li> </ul>
<p><b>17 Sound</b> Zet het hoorbare alarm van de unit aan of uit.          Bereik: aan of UIT          Fabrieeksstandaard: aan</p> <ul style="list-style-type: none"> <li>Druk op <b>enter</b></li> <li>Het display zal knipperen tussen Sounden aan</li> <li>Druk, indien gewenst, op  om OFF weer te geven</li> <li>Druk op <b>enter</b></li> </ul>	<p><b>18 StArT</b> schakelt de auto restart in en uit.          Bereik: aan of UIT          Fabrieeksstandaard: UIT</p> <ul style="list-style-type: none"> <li>Druk op <b>enter</b></li> <li>Het display zal knipperen tussen StArT en UIT</li> <li>Druk, indien gewenst, op  om aan weer te geven</li> <li>Druk op <b>enter</b></li> </ul>	<p><b>19 CArE</b> wordt gebruikt om de frequentie van de herinnering voor het preventief schoonmaken van de lucht- en vloeistoffilters van de unit in te stellen.          Bereik: uit, L1 - 1000 uur, L2 - 2000 uur, L3 - 3000 uur          Fabrieeksstandaard: L1</p> <ul style="list-style-type: none"> <li>Druk op <b>enter</b></li> <li>Het display zal knipperen tussen CArE en L1</li> <li>Gebruik, indien gewenst,  om het display te wijzigen in uit, L2 of L3</li> <li>Druk op <b>enter</b></li> </ul>	<p><b>Optie - Seriële communicatie (DCOM) - Stappen D tot I</b></p> <p><b>D SER</b> wordt gebruikt voor het inschakelen/uitschakelen en configureren van de seriële-communicatiemodus          Bereik: uit, rS232, rS485          Fabrieeksstandaard: uit</p> <ul style="list-style-type: none"> <li>Druk op <b>enter</b></li> <li>Het display zal knipperen tussen SER en UIT</li> <li>Indien gewenst kunt u  gebruiken om de modus te wijzigen</li> <li>Druk op <b>enter</b></li> </ul> <p><b>E BAud</b> wordt gebruikt om de baudrate (snelheid) voor seriële communicatie te kiezen.          Bereik: 9600, 4800, 2400, 1200, 600 of 300 bits per seconde.</p> <ul style="list-style-type: none"> <li>Druk op <b>enter</b></li> <li>Het display zal knipperen tussen BAud en 9600</li> <li>Indien gewenst kunt u  gebruiken om de snelheid te wijzigen</li> <li>Druk op <b>enter</b></li> </ul> <p><b>F dATA</b> wordt gebruikt om het aantal bits weer te geven.          Display: 8</p> <ul style="list-style-type: none"> <li>Druk op <b>enter</b></li> <li>Het display zal knipperen tussen dATA en 8</li> <li>Druk op <b>enter</b></li> </ul> <p><b>G StOp</b> wordt gebruikt om het aantal stopbits aan te geven.          Bereik: 2 of 1          Fabrieeksstandaard: 1</p> <ul style="list-style-type: none"> <li>Druk op <b>enter</b></li> <li>Het display zal knipperen tussen StOp en 1</li> <li>Indien gewenst kunt u  gebruiken om de instelling te wijzigen</li> <li>Druk op <b>enter</b></li> </ul>
<p><b>20 Store</b> Druk op  om alle instellingen op te slaan</p> <p><b>De unit zal automatisch starten.</b></p> <ul style="list-style-type: none"> <li>Druk op  om alle wijzigingen ongedaan te maken en de standaard fabrieksstanden te herstellen. Het display zal blanco zijn.</li> <li>Druk op  om de procedure opnieuw te starten.</li> </ul>	<p>De Setup-procedure is nu voltooid.          Als de unit start, zal de besturing de temperatuur van de procesvloeistof weergeven.          Indien gewenst kunt u het setpoint van de unit wijzigen/controleren door op <b>mode</b> te drukken.</p>	<p><b>19 SP</b> wordt gebruikt om het setpoint aan te passen.          Bereik: +5°C tot +40°C          Fabrieeksstandaard: +20°C</p> <ul style="list-style-type: none"> <li>Het display zal knipperen tussen SP en 20</li> <li>Indien gewenst kunt u  gebruiken om de instelling te wijzigen</li> <li>Druk op <b>enter</b> om het nieuwe setpoint op te slaan en naar de temperatuurweergave terug te keren</li> </ul>	<p><b>Optie - Universele spanning - Stap A</b></p> <p><b>A HZ</b></p> <ul style="list-style-type: none"> <li>Druk op <b>enter</b></li> <li>Het display zal knipperen tussen HZ en 60</li> <li>Gebruik, indien nodig,  om de frequentie te wijzigen</li> <li>Druk op <b>enter</b> om naar de volumestroomomzetter of seriële communicatie heeft, zie stap 20.</li> </ul>
<p><b>Raadpleeg, indien van toepassing, de kaders rechts voor het instellen van de opties. Raadpleeg voor units met Analogue I/O (ACOM) de additionele quick start die bij de unit is geleverd.</b></p>			

# Preface

## Compliance Third Party:

**CSA Listed** - Laboratory equipment-electrical

**File #** 105974\_C\_000

**CLASS:** 8721-05 CAN/CSA-C22.2 No. 61010-1-04

**CLASS:** 8721-85 ANSI/UL Standard 61010-1



## European Union ( EU ) LVD & EMC

Our evaluation has demonstrated compliance with EU directives, as indicated by the CE Mark located on the chiller's nameplate and the Declaration of Conformity in the back of this manual.



## WEEE

This product is required to comply with the European Union's Waste Electrical & Electronic Equipment (WEEE) Directive 2002/96/EC. It is marked with the following symbol:



Thermo Fisher Scientific has contracted with one or more recycling/disposal companies in each EU Member State, dispose of or recycle this product through them. Further information on Thermo Fisher Scientific's compliance with these Directives is available at:  
[www.thermoscientific.com/WEEERoHS](http://www.thermoscientific.com/WEEERoHS)

## After-sale Support

Thermo Fisher Scientific is committed to customer service both during and after the sale. If you have questions concerning the chiller operation, or questions concerning spare parts or Service Contracts, call our Sales, Service and Customer Support phone number, see this manual's inside cover for contact information.

When calling, please refer to the labels on the inside cover. These labels list all the necessary information needed to properly identify your chiller.

## Feedback

We appreciate any feedback you can give us on this manual. Please e-mail us at [tcmanuals@thermofisher.com](mailto:tcmanuals@thermofisher.com). Be sure to include the manual part number and the revision date listed on the front cover.

## Warranty

Thermo Scientific ThermoFlex chillers have a warranty against defective parts and workmanship for 24 months (**excluding MD1/MD2 Magnetic Drive and P1/P2 Positive Displacement pumps which are warranted for 12 months**) from date of shipment. See back page for more details.

## Unpacking

If the chiller has a line cord it is located under the shipping crate's lid. Do not discard the lid until the cord is located.

Locate the reservoir fluid filter bag and ensure it installed before the chiller is operated. See Section 3.

Retain all cartons and packing material until the chiller is operated and found to be in good condition. If it shows external or internal damage contact the transportation company and file a damage claim. Under ICC regulations, this is your responsibility.

### Out of Box Failure

An Out of Box Failure is defined as any product that fails to operate in conformance with sellers published specifications at initial power up. Install the chiller in accordance with manufacturer's recommended operating conditions within 30 days of shipment from the seller.

Any Temperature Control product meeting the definition of an Out of Box Failure must be packed and shipped back in the original packaging to Thermo Fisher Scientific for replacement with a new chiller; seller to pay the cost of shipping. Customer must receive a Return Material Authorization (RMA) from Thermo Fisher prior to shipping.

# Section 1 Safety

## Safety Warnings

Make sure you read and understand all instructions and safety precautions listed in this manual before installing or operating your chiller. If you have any questions concerning the operation or the information in this manual, please contact us. See inside cover for contact information.



**DANGER** indicates an imminently hazardous situation which, if not avoided, *will* result in death or serious injury.



**WARNING** indicates a potentially hazardous situation which, if not avoided, *could* result in death or serious injury.



**CAUTION** indicates a potentially hazardous situation which, if not avoided, may result in minor or moderate injury. It is also used to alert against unsafe practices.



The lightning flash with arrow symbol, within an equilateral triangle, is intended to alert the user to the presence of non-insulated "dangerous voltage" within the chiller's enclosure. The voltage magnitude is significant enough to constitute a risk of electrical shock.



This label indicates read the manual.

**Never place the chiller in a location where excessive heat, moisture, or corrosive materials are present. ▲**

**The chiller's construction provides protection against the risk of electrical shock by grounding appropriate metal parts. The protection will not function unless the power cord is connected to a properly grounded outlet. It is the user's responsibility to assure a proper ground connection is provided. ▲**

**Never connect the process fluid inlet or outlet fittings to your building water supply or any water pressure source. ▲**

**Do not use automotive antifreeze. Commercial antifreeze contains silicates that can damage the pump seals. Use of automotive antifreeze will void the manufacturer's warranty. ▲**

**To prevent freezing/glazing of the plate exchanger, ThermoFlex7500 through ThermoFlex24000 chillers require the use of 50/50 EG/water or 50/50 PG/water below 10°C process temperature. ▲**



**Before using any fluid or performing maintenance where contact with the fluid is likely refer to the manufacturer's MSDS for handling precautions. ▲**

**When using a process fluid mixture of ethylene glycol and water or propylene glycol and water, check the fluid concentration and pH on a regular basis. Changes in concentration and pH can impact system performance. See Section 3. ▲**

**Many refrigerants which may be undetectable by human senses are heavier than air and will replace the oxygen in an enclosed area causing loss of consciousness. Contact with leaking refrigerant will cause skin burns. Refer to the chiller's nameplate and the manufacturer's most current MSDS for additional information. ▲**

**Performance of installation, operation, or maintenance procedures other than those described in this manual may result in a hazardous situation and may void the manufacturer's warranty. ▲**

**Transport the chiller with care. Sudden jolts or drops can damage its components. ▲**

**Drain the chiller before it is transported and/or stored in near or below freezing temperatures, see Draining in Section 8. Store the chiller in the temperature range -25°C to 60°C (with packaging), and <80% relative humidity. ▲**

**For ThermoFlex900-10000 chillers, the circuit protector located on the rear is not intended to act as a disconnecting means. ▲**

**Observe and never remove warning labels. ▲**

**Never operate damaged or leaking equipment. ▲**

**Never operate the chiller without process fluid in the reservoir. ▲**

**Always turn off the chiller and disconnect the power cord from the power source before performing any service or maintenance procedures, or before moving. ▲**

**Never operate the chiller with panels removed. ▲**

**Never operate equipment with damaged power cords. ▲**

**Refer service and repairs to a qualified technician. ▲**

## Section 2 General Information

### Description

The Thermo Scientific ThermoFlex™ recirculating chillers are designed to provide a continuous supply of fluid at a constant temperature and flow rate. The chiller consists of an air-cooled or water-cooled refrigeration system, heat exchanger, recirculating pump, polyethylene reservoir and a microprocessor controller.

### Specifications

	ThermoFlex900	ThermoFlex1400	ThermoFlex2500
<b>Process Fluid Temperature and Setpoint Range</b>	+5°C to +40°C +41°F to +104°F	+5°C to +40°C +41°F to +104°F	+5°C to +40°C +41°F to +104°F
<b>Ambient Temperature Range</b>	+10°C to +40°C +50°F to +104°F	+10°C to +40°C +50°F to +104°F	+10°C to +40°C +50°F to +104°F
<b>Temperature Stability</b>	±0.1°C	±0.1°C	±0.1°C
<b>Cooling Capacity at 20°C</b> 60 Hz 50 Hz	900 W (3074 BTU) 750 W (2561 BTU)	1400 W (4781 BTU) 1170 W (3996 BTU)	2500 W (8538 BTU)* 2200 W (7513 BTU)
*To meet this specification, the ThermoFlex2500 air-cooled chillers require the fan to be operating in the high-speed mode, see Section 3.			
<b>Refrigerant</b>	R134A	R134A	R134A
<b>Reservoir Volume</b> Gallons Liters	1.9 7.2	1.9 7.2	1.9 7.2
<b>Footprint or Dimensions (H x W x D)</b> Inches Centimeters	27.3 x 14.2 x 24.6 69.2 x 36.0 x 62.4	27.3 x 14.2 x 24.6 69.2 x 36.0 x 62.4	29.0 x 17.2 x 26.5 73.6 x 43.6 x 67.3
<b>Weight P2 Pump (empty)</b> lb kg	130.5 59.2	130.5 59.2	175.5 79.6
<b>Pumping Capacity</b>			
P1/MD1 - Positive Displacement 60 Hz 50 Hz		2.1 gpm @ 60 psig (7.9 lpm @ 4.1 bar) 1.7 gpm @ 60 psig (6.4 lpm @ 4.1 bar)	
P2/MD2 - Positive Displacement 60 Hz 50 Hz		4.0 gpm @ 60 psig (15.1 lpm @ 4.1 bar) 3.3 gpm @ 60 psig (12.5 lpm @ 4.1 bar)	
T0 - Turbine 60 Hz* 50 Hz*		2.0 gpm @ 60 psid (7.6 lpm @ 4.1 bar) 1.3 gpm @ 60 psid (4.9 lpm @ 4.1 bar)	
T1 - Turbine 60 Hz* 50 Hz*		3.5 gpm @ 60 psid (13.3 lpm @ 4.1 bar) 2.5 gpm @ 60 psid (9.5 lpm @ 4.1 bar)	

\* Pressure values for turbine pumps are differential pressures between the inlet and the outlet of the chiller.

- Cooling capacity based on P2 pumps with no backpressure. Heat input from the pump will result in a reduction in cooling capacity. The cooling capacity reduction will vary based on the pump chosen as well as pump backpressure and flow.
- Specifications obtained at sea level using water as the recirculating fluid, at a 20°C process setpoint, 25°C ambient condition, at nominal operating voltage. Other fluids, fluid temperatures, ambient temperatures, altitude or operating voltages will affect performance. See Section 3.
- Additional dimensions are at the end of this section, add 1/8" (3 mm) to height for SEMI.
- Add 5 pounds (2 kilograms) for global voltage chillers.
- Thermo Fisher Scientific reserves the right to change specifications without notice.

## Specifications

	ThermoFlex3500	ThermoFlex5000
<b>Process Fluid Temperature and Setpoint Range</b>	+5°C to +40°C +41°F to +104°F	+5°C to +40°C +41°F to +104°F
<b>Ambient Temperature Range</b>	+10°C to +40°C +50°F to +104°F	+10°C to +40°C +50°F to +104°F
<b>Temperature Stability</b>	± 0.1°C	± 0.1°C
<b>Cooling Capacity at 20°C</b> 60 Hz 50 Hz	3500 W (11953 BTU) 3050 W (10416 BTU)	5000 W (17076 BTU) 4400 W (15027 BTU)
<b>Refrigerant</b>	R407C	R407C
<b>Reservoir Volume</b> Gallons Liters	1.9 7.2	1.9 7.2
<b>Footprint or Dimensions (H x W x D)</b> Inches Centimeters	38.9 x 19.3 x 30.9 98.7 x 48.8 x 78.4	38.9 x 19.3 x 30.9 98.7 x 48.8 x 78.4
<b>Weight P 1/ P 2/P 3/P 4 (empty)</b> lb kg	264/264/270/303 120/120/123/138	NA/264/270/303 NA/120/123/138
<b>Pumping Capacity</b>		
P 1/MD 1 - Positive Displacement 60 Hz 50 Hz	2.1 gpm @ 60 psig (7.9 lpm @ 4.1 bar) 1.7 gpm @ 60 psig (6.4 lpm @ 4.1 bar)	Not Available Not Available
P 2/MD 2 - Positive Displacement 60 Hz 50 Hz	4.0 gpm @ 60 psig (15.1 lpm @ 4.1 bar) 3.3 gpm @ 60 psig (12.5 lpm @ 4.1 bar)	4.0 gpm @ 60 psig (15.1 lpm @ 4.1 bar) 3.3 gpm @ 60 psig (12.5 lpm @ 4.1 bar)
T 1 - Turbine 60 Hz* 50 Hz*	3.5 gpm @ 60 psid (13.3 lpm @ 4.1 bar) 2.5 gpm @ 60 psid (9.5 lpm @ 4.1 bar)	3.5 gpm @ 60 psid (13.3 lpm @ 4.1 bar) 2.5 gpm @ 60 psid (9.5 lpm @ 4.1 bar)
P 3 - Centrifugal Pump 60 Hz* 50 Hz*	10 gpm @ 32 psid (37.9 lpm @ 2.2 bar) 10 gpm @ 20 psid (37.9 lpm @ 1.4 bar)	10 gpm @ 32 psid (37.9 lpm @ 2.2 bar) 10 gpm @ 20 psid (37.9 lpm @ 1.4 bar)
P 4 - Centrifugal Pump 60 Hz* 50 Hz*	15 gpm @ 57 psid (56.8 lpm @ 3.9 bar) 15 gpm @ 34 psid (56.8 lpm @ 2.3 bar)	15 gpm @ 57 psid (56.8 lpm @ 3.9 bar) 15 gpm @ 34 psid (56.8 lpm @ 2.3 bar)

\* Pressure values for turbine and centrifugal pumps are differential pressures between the inlet and the outlet of the chiller.

- Cooling capacity based on P 2 pumps with no backpressure. Heat input from the pump will result in a reduction in cooling capacity. The cooling capacity reduction will vary based on the pump chosen as well as pump backpressure and flow.
- Specifications obtained at sea level using water as the recirculating fluid, at a 20°C process setpoint, 25°C ambient condition, at nominal operating voltage. Other fluids, fluid temperatures, ambient temperatures, altitude or operating voltages will affect performance. See Section 3.
- Additional dimensions are at the end of this section, add 1/8" (3 cm) to height for SEMI.
- Add 30 pounds (14 kilograms) for global voltage chillers.
- Thermo Fisher Scientific reserves the right to change specifications without notice.



## Specifications

	ThermoFlex7500	ThermoFlex10000
<b>Process Fluid Temperature and Setpoint Range</b>	+5°C to +40°C +41°F to +104°F	+5°C to +40°C +41°F to +104°F
<b>Ambient Temperature Range</b>	+10°C to +40°C +50°F to +104°F	+10°C to +40°C +50°F to +104°F
<b>Temperature Stability</b>	±0.1°C	±0.1°C
<b>Cooling Capacity at 20°C</b> 60 Hz 50 Hz	7500 W (25575 BTU) 6425 W (21910 BTU)	10000 W (34100 BTU) 8500 W (28985 BTU)
<b>Refrigerant</b>	R407C	R407C
<b>Reservoir Volume</b> Gallons Liters	4.75 17.9	4.75 17.9
<b>Footprint or Dimensions (H x W x D)</b>		
Air-Cooled Inches	52.3 x 25.2 x 33.8	52.3 x 25.2 x 33.8
Centimeters	132.7 x 63.9 x 85.6	132.7 x 63.9 x 85.6
Water-Cooled Inches	45.9 x 25.2 x 33.8	45.9 x 25.2 x 33.8
Centimeters	116.6 x 63.9 x 85.6	116.6 x 63.9 x 85.6
<b>Weight P2/P3/P5 (empty)</b>		
Air-Cooled lb	356/372.5/405.5	356/372.5/405.5
kg	161.5/169/184	161.5/169/184
Water-Cooled lb	315/331.5/364.5	315/331.5/364.5
kg	143/150/165	143/150/165
<b>Pumping Capacity</b>		
P2/MD2 - Positive Displacement 60 Hz	4.0 gpm @ 60 psig (15.1 lpm @ 4.1 bar)	4.0 gpm @ 60 psig (15.1 lpm @ 4.1 bar)
50 Hz	3.3 gpm @ 60 psig (12.5 lpm @ 4.1 bar)	3.3 gpm @ 60 psig (12.5 lpm @ 4.1 bar)
P3 - Centrifugal Pump 60 Hz*	10 gpm @ 32 psid (37.9 lpm @ 2.2 bar)	10 gpm @ 32 psid (37.9 lpm @ 2.2 bar)
50 Hz*	10 gpm @ 20 psid (37.9 lpm @ 1.4 bar)	10 gpm @ 20 psid (37.9 lpm @ 1.4 bar)
P5 - Centrifugal Pump 60 Hz*	20 gpm @ 60 psid (75.7 lpm @ 4.1 bar)	20 gpm @ 60 psid (75.7 lpm @ 4.1 bar)
50 Hz*	20 gpm @ 35 psid (75.7 lpm @ 2.4 bar)	20 gpm @ 35 psid (75.7 lpm @ 2.4 bar)
T 5 - Turbine Pump 60 Hz*	8.0 gpm @ 52 psid (30.3 lpm @ 3.6 bar)	8.0 gpm @ 52 psid (30.3 lpm @ 3.6 bar)
50 Hz*	8.0 gpm @ 20 psid (30.3 lpm @ 1.4 bar)	8.0 gpm @ 20 psid (30.3 lpm @ 1.4 bar)

\* Pressure values for centrifugal and turbine pumps are differential pressures between the inlet and the outlet of the chiller.

- Cooling capacity based on P2 pumps with no backpressure. Heat input from the pump will result in a reduction in cooling capacity. The cooling capacity reduction will vary based on the pump chosen as well as pump backpressure and flow.
- Specifications obtained at sea level using water as the recirculating fluid, at a 20°C process setpoint, 25°C ambient condition, at nominal operating voltage. Other fluids, fluid temperatures, ambient temperatures, altitude or operating voltages will affect performance. See Section 3.
- Additional dimensions are at the end of this section.
- Add 30 pounds (14 kilograms) for global voltage chillers with a P2 pump. Add 10 pounds (4.5 kilograms) for chillers with a P3 or P5 pump.
- Thermo Fisher Scientific reserves the right to change specifications without notice.

## Specifications

	ThermoFlex15000	ThermoFlex20000	ThermoFlex24000
<b>Process Fluid Temperature and Setpoint Range</b>	+5°C to +40°C +41°F to +104°F	+5°C to +40°C +41°F to +104°F	+5°C to +40°C +41°F to +104°F
<b>Ambient Temperature Range</b>	+10°C to +40°C +50°F to +104°F	+10°C to +40°C +50°F to +104°F	+10°C to +40°C +50°F to +104°F
<b>Temperature Stability</b>	±0.1°C	±0.1°C	±0.1°C
<b>Cooling Capacity at 20°C</b>			
60 Hz	15000 W (51228 BTU)	20000 W (68304 BTU)	24000 W (81964 BTU)
50 Hz	12525 W (42775 BTU)	16700 W (57043 BTU)	21000 W (71719 BTU)
<b>Refrigerant</b>	R407C	R407C	R407C
<b>Reservoir Volume</b>			
Gallons	4.75	4.75	4.75
Liters	17.9	17.9	17.9
<b>Footprint or Dimensions (H x W x D)</b>			
Air-Cooled Inches	49.0 x 46.5 x 30.9	49.0 x 46.5 x 30.9	58.6 x 46.5 x 30.9
Centimeters	124.4 x 118.1 x 78.6	124.4 x 118.1 x 78.6	148.9 x 118.1 x 78.6
Water-Cooled Inches	49.0 x 46.5 x 30.9	49.0 x 46.5 x 30.9	49.0 x 46.5 x 30.9
Centimeters	124.4 x 118.1 x 78.6	124.4 x 118.1 x 78.6	124.4 x 118.1 x 78.6
<b>Weight (empty)</b>			
Air-Cooled lb	550	550	650
kg	249.5	249.5	294.8
Water-Cooled lb	510	510	510
kg	231.3	231.3	231.3
<b>Pumping Capacity</b>			
P3 - Centrifugal Pump 60 Hz*		10 gpm @ 32 psid (37.9 lpm @ 2.2 bar)	
50 Hz*		10 gpm @ 20 psid (37.9 lpm @ 1.4 bar)	
P5 - Centrifugal Pump 60 Hz*		20 gpm @ 60 psid (75.7 lpm @ 4.1 bar)	
50 Hz*		20 gpm @ 35 psid (75.7 lpm @ 2.4 bar)	

\* Pressure values are differential pressures between the inlet and the outlet of the chiller.

- Cooling capacity based on P3 pumps set at 10 gpm. Heat input from the pump will result in a reduction in cooling capacity. The cooling capacity reduction will vary based on the pump chosen as well as pump backpressure and flow.
- Specifications obtained at sea level using water as the recirculating fluid, at a 20°C process setpoint, 25°C ambient condition, at nominal operating voltage. Other fluids, fluid temperatures, ambient temperatures, altitude or operating voltages will affect performance. See Section 3.
- Additional dimensions are at the end of this section.
- Thermo Fisher Scientific reserves the right to change specifications without notice.

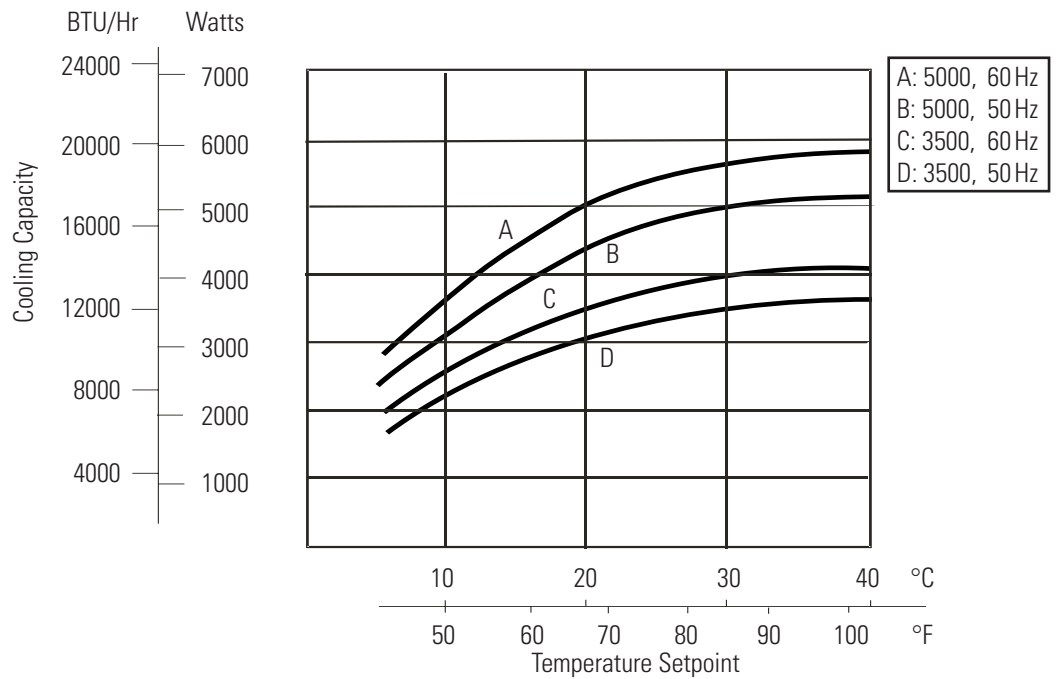
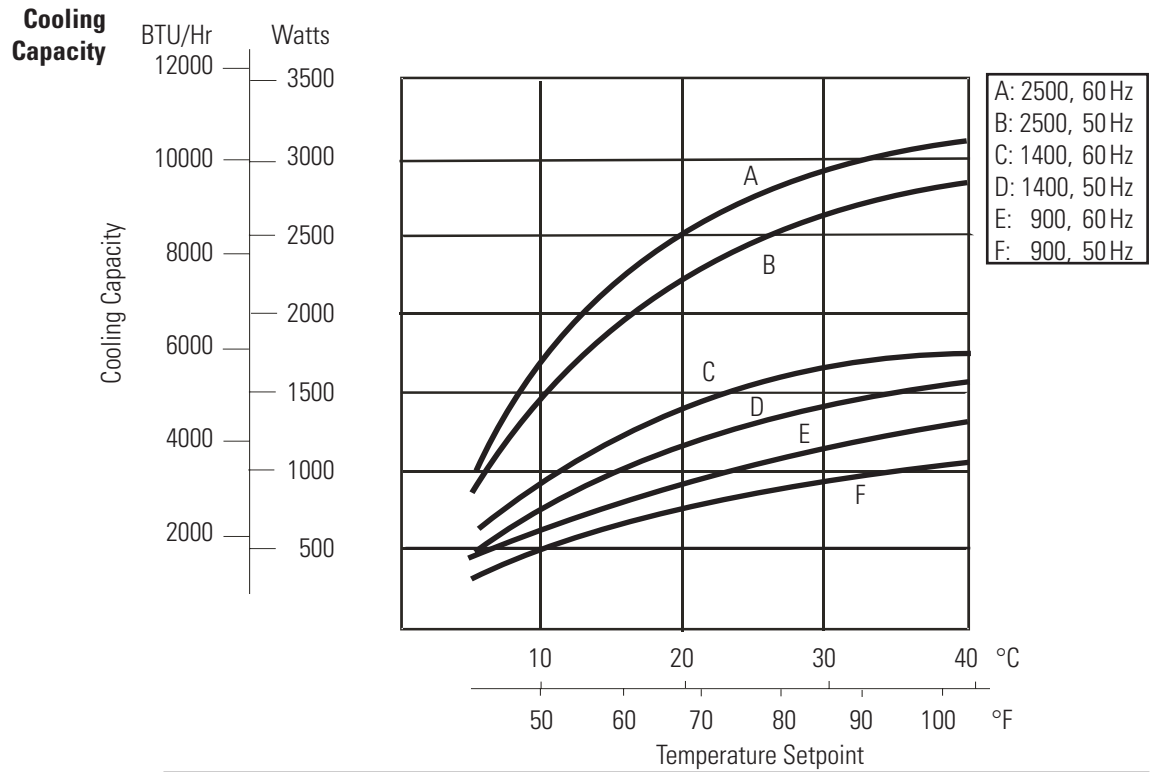

- Specifications obtained at sea level using water as the recirculating fluid, at a 20°C process setpoint, 25°C ambient condition, at nominal operating voltage, on chillers with P2 pumps with no back pressure. Other fluids, fluid temperatures, ambient temperatures, altitude, operating voltages or pumps will affect performance. See Section 3.
- Thermo Fisher Scientific reserves the right to change specifications without notice.

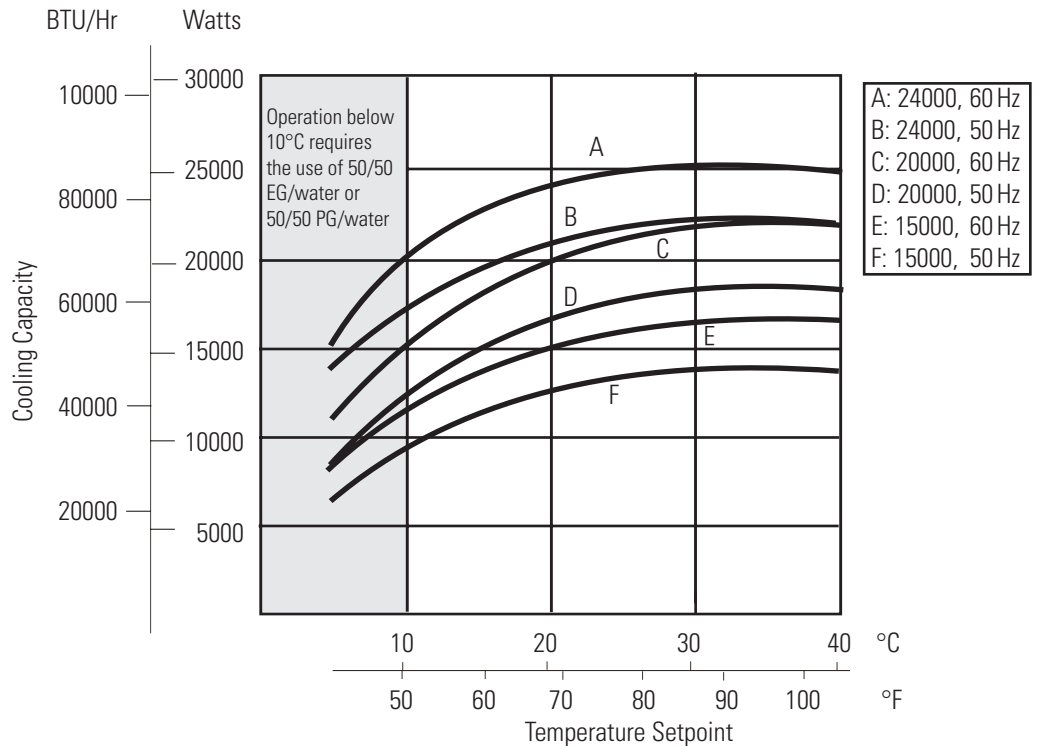
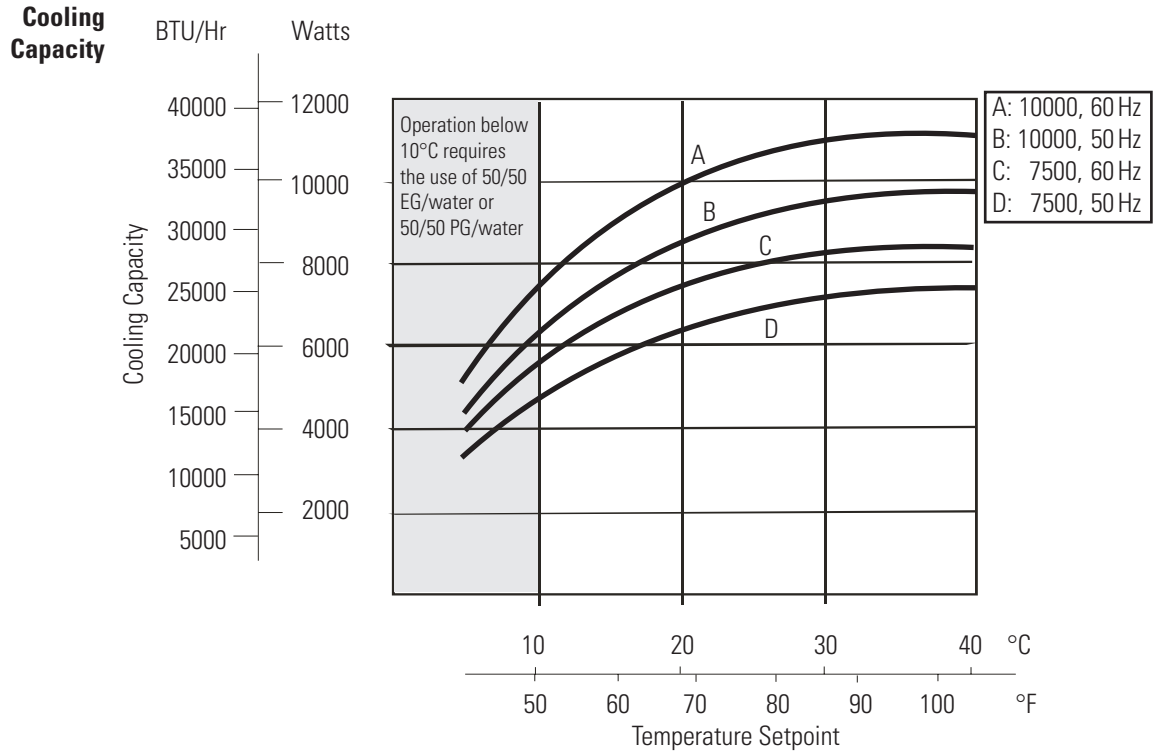

- Specifications obtained at sea level using water as the recirculating fluid, at a 20°C process setpoint, 25°C ambient condition, at nominal operating voltage, on chillers with P2 pumps with no back pressure (P3 pumps set to 10 gpm for ThermoFlex15000 to 24000). Other fluids, fluid temperatures, ambient temperatures, altitude, operating voltages or pumps will affect performance. See Section 3.
- Chillers require the use of 50/50 EG/water or 50/50 PG/water below 10°C process temperature to prevent freezing/glazing of the plate exchanger.
- Thermo Fisher Scientific reserves the right to change specifications without notice.

**Pumping Capacity  
Positive Displacement Pump P1/P2  
Magnetic Drive Pumps MD1/MD2**

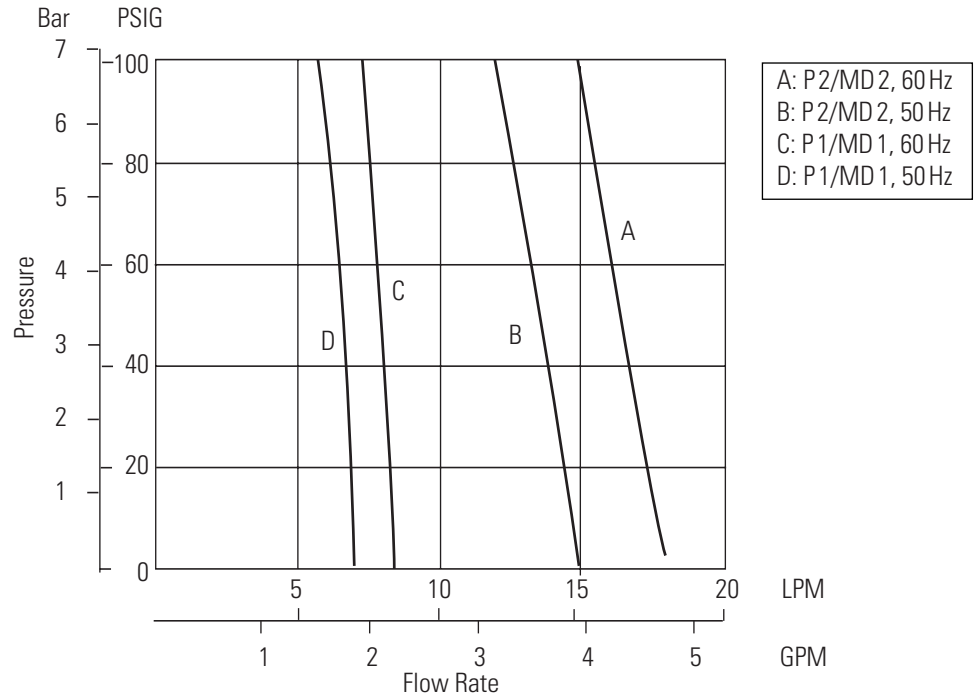

**Pumping Capacity  
Centrifugal Pump P3/P4**

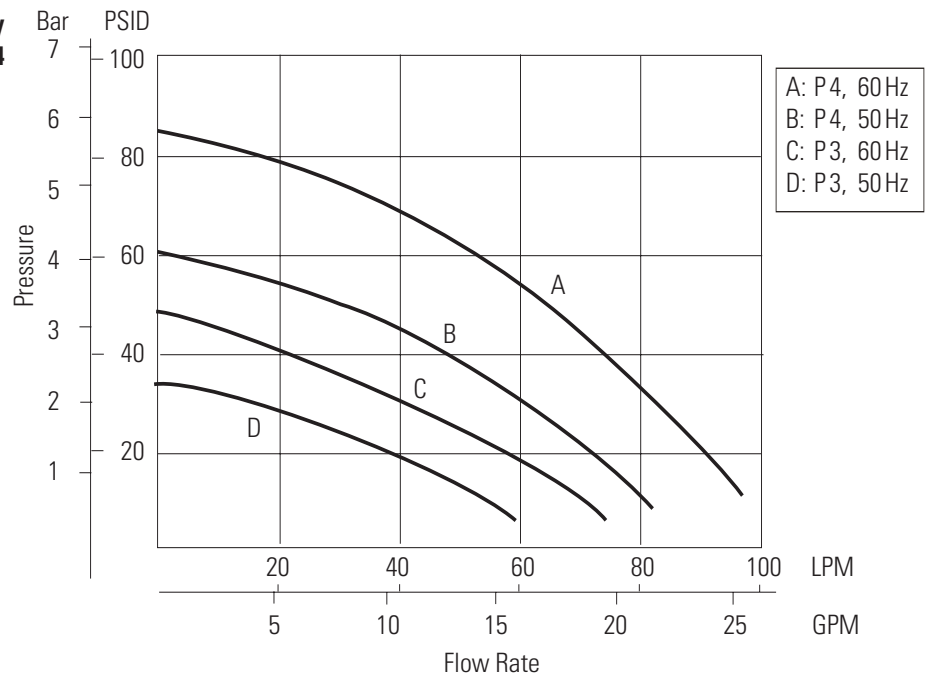

- Pump curves are nominal values. Pressure values for centrifugal pumps are differential pressures between the inlet and the outlet of the chiller.
- Pump performance results were obtained with no restrictions on the return to the system or with any options installed. For example, utilizing the DI option will result in a 0.5 gpm flow reduction .
- Specifications obtained at sea level using water as the recirculating fluid, at a 20°C process setpoint, 25°C ambient condition, at nominal operating voltage. Other fluids, fluid temperatures, ambient temperatures, altitude or operating voltages will affect performance. See Section 3.
- Thermo Fisher Scientific reserves the right to change specifications without notice.

**Pumping Capacity  
Centrifugal Pump P5**

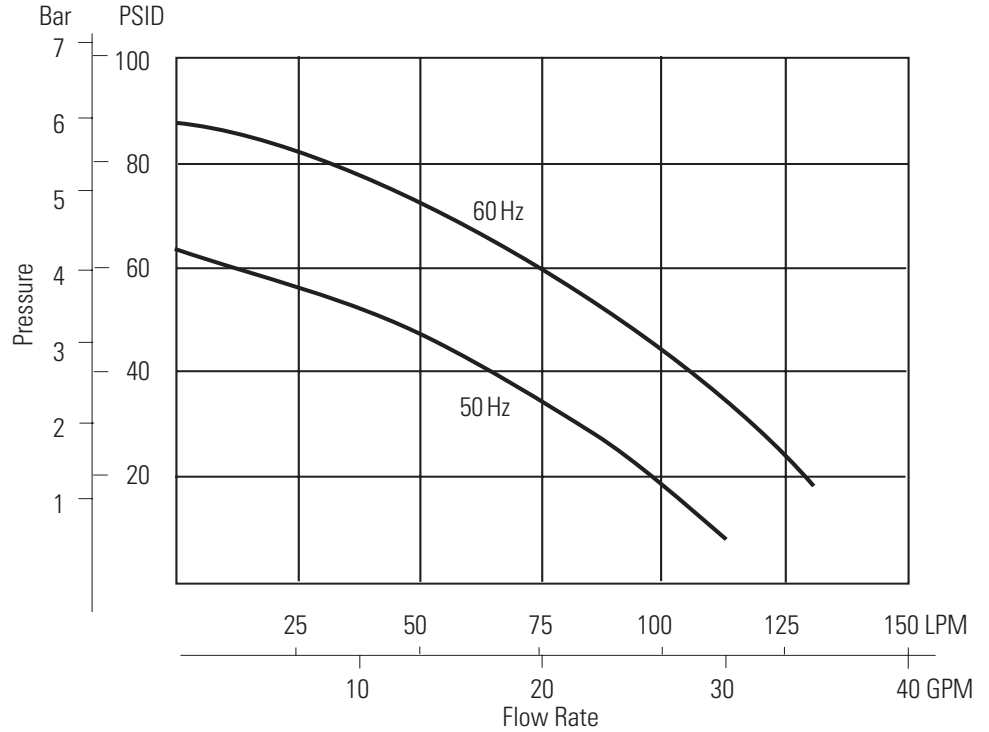

**Pumping Capacity  
Turbine Pump T1/T5**

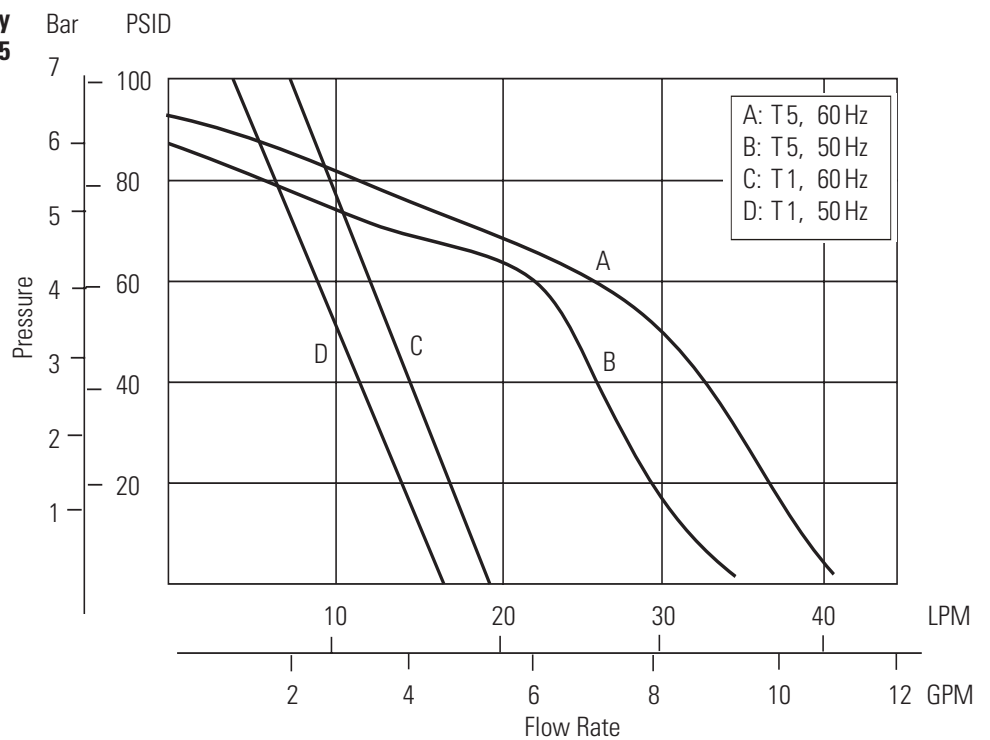

- Pump curves are nominal values. Pressure values for centrifugal and turbine pumps are differential pressures between the inlet and the outlet of the chiller.
- Pump performance results were obtained with no restrictions on the return to the system or with any options installed. For example, utilizing the DI option will result in a 0.5 gpm flow reduction.
- Specifications obtained at sea level using water as the recirculating fluid, at a 20°C process setpoint, 25°C ambient condition, at nominal operating voltage. Other fluids, fluid temperatures, ambient temperatures, altitude or operating voltages will affect performance. See Section 3.
- Thermo Fisher Scientific reserves the right to change specifications without notice.

### Pumping Capacity Turbine Pump T0

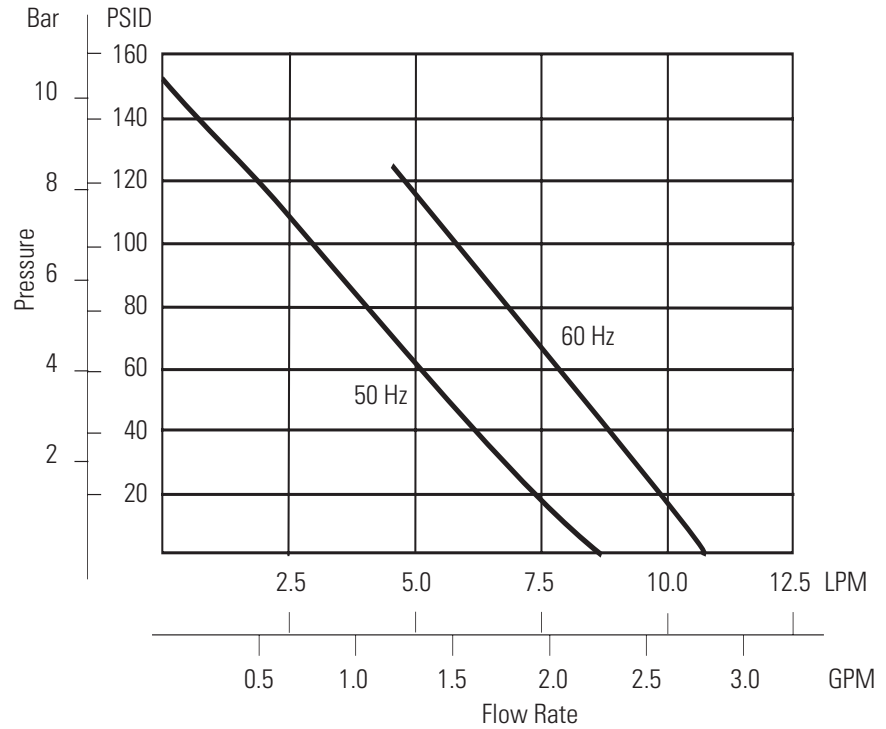

- Pump curves are nominal values. Pressure values for turbine pumps are differential pressures between the inlet and the outlet of the chiller.
- Pump performance results were obtained with no restrictions on the return to the system or with any options installed. For example, utilizing the DI option will result in a 0.5 gpm flow reduction .
- Specifications obtained at sea level using water as the recirculating fluid, at a 20°C process setpoint, 25°C ambient condition, at nominal operating voltage. Other fluids, fluid temperatures, ambient temperatures, altitude or operating voltages will affect performance. See Section 3.
- Thermo Fisher Scientific reserves the right to change specifications without notice.

**ThermoFlex900/1400**  
**Dimensions**  
 (inches/centimeters)

Front View

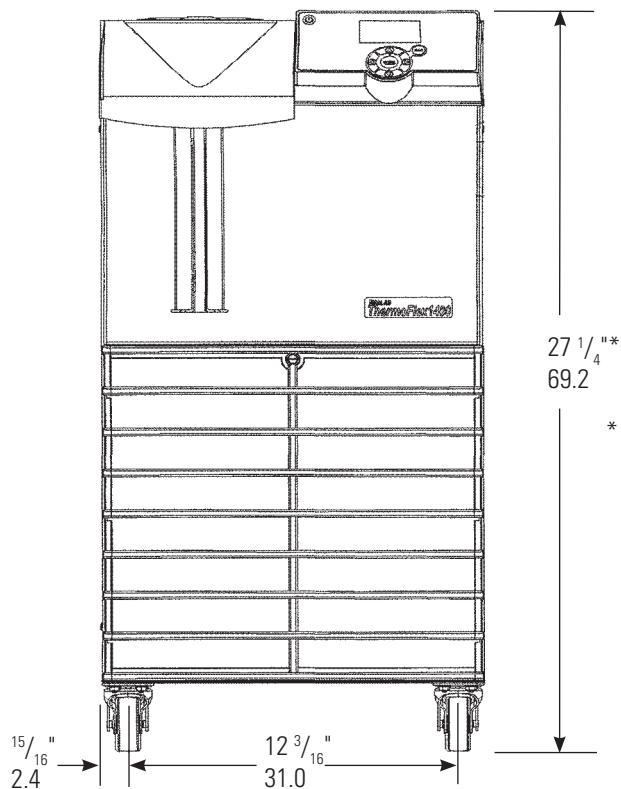

Side View

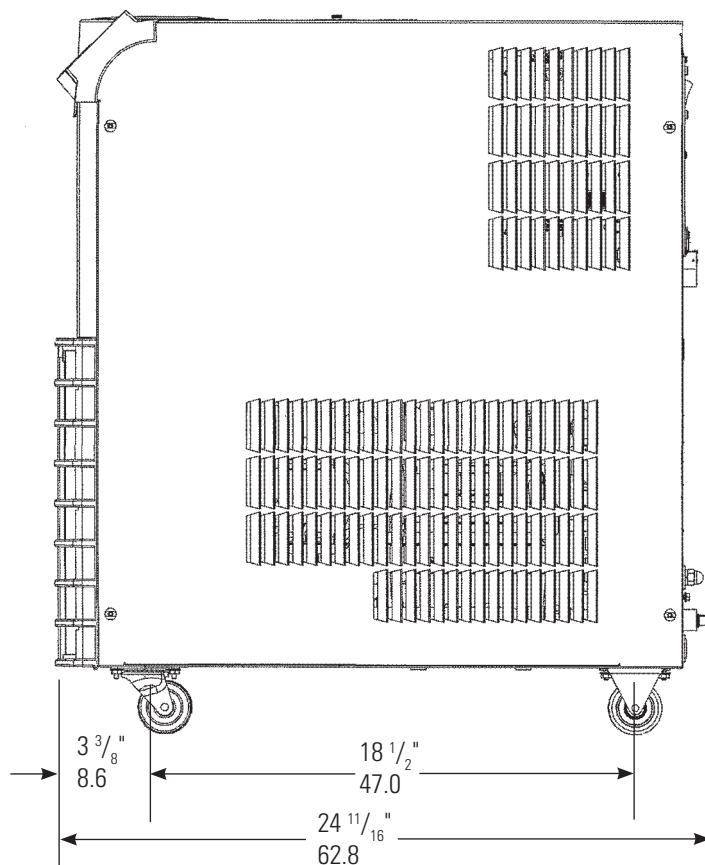

• Thermo Fisher Scientific reserves the right to change specifications without notice.



**ThermoFlex900/1400**

Process discharge for chillers with optional flow transducer or Internal pressure regulator adjustment (Optional)  
1/2" FNPT Stainless Steel 

Rear View

Process discharge fluid connection  
1/2" FNPT Cast Bronze 

Process fluid return connection  
1/2" FNPT Stainless Steel 

See Section 3 for additional plumbing information.



Process fluid drain  
(1/4" FNPT) Riton

Optional 1/2" Auxiliary and 1/4" Auto-Refill Ports

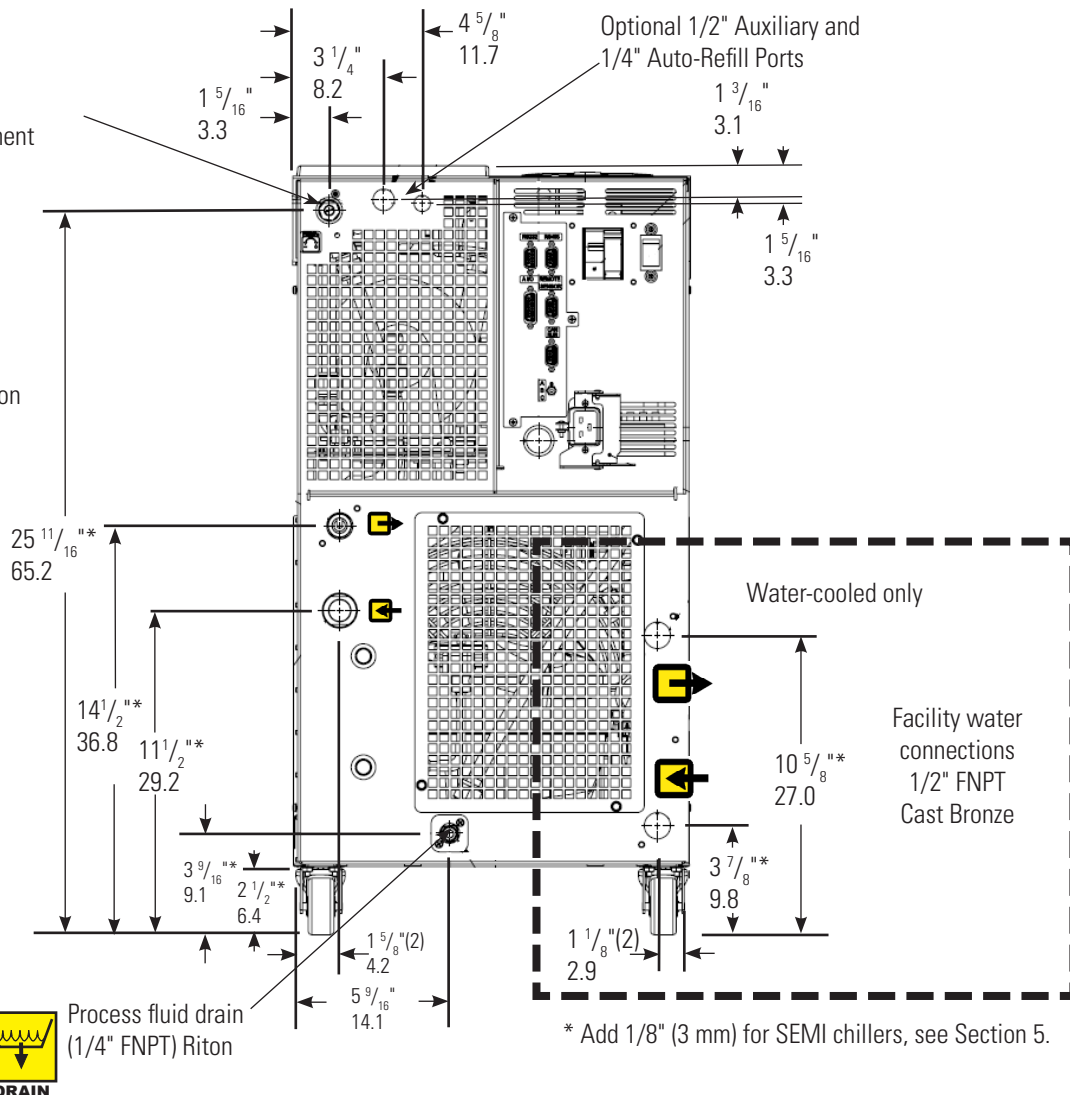

\* Add 1/8" (3 mm) for SEMI chillers, see Section 5.

Top View

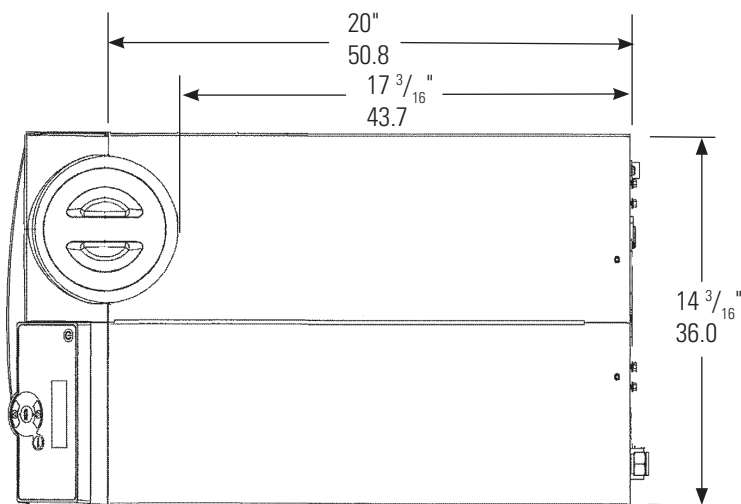

Shipping crate dimensions (approximate):

- 21" (53 cm) wide
- 35" (89 cm) tall
- 40" (102 cm) deep

• Thermo Fisher Scientific reserves the right to change specifications without notice.

**ThermoFlex2500**  
**Dimensions**  
 (inches/centimeters)

Front View

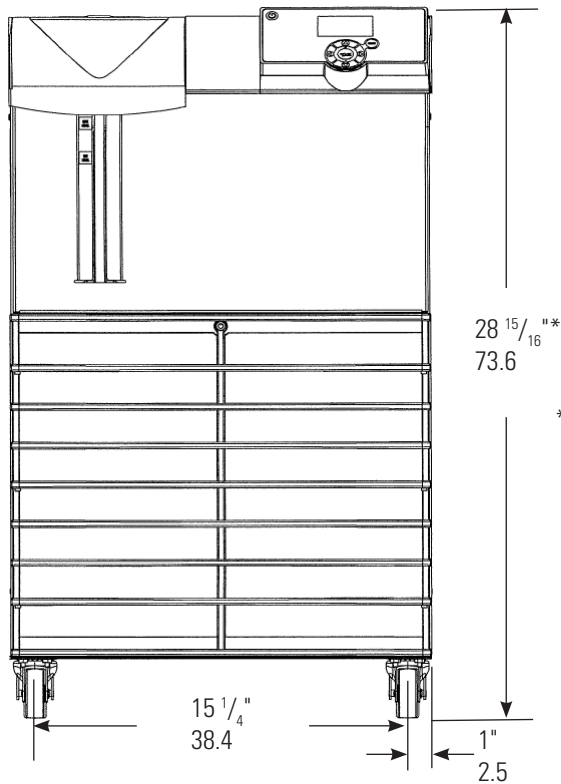

\* Add 1/8" (3 mm) for SEMI chillers, see Section 5.

Side View

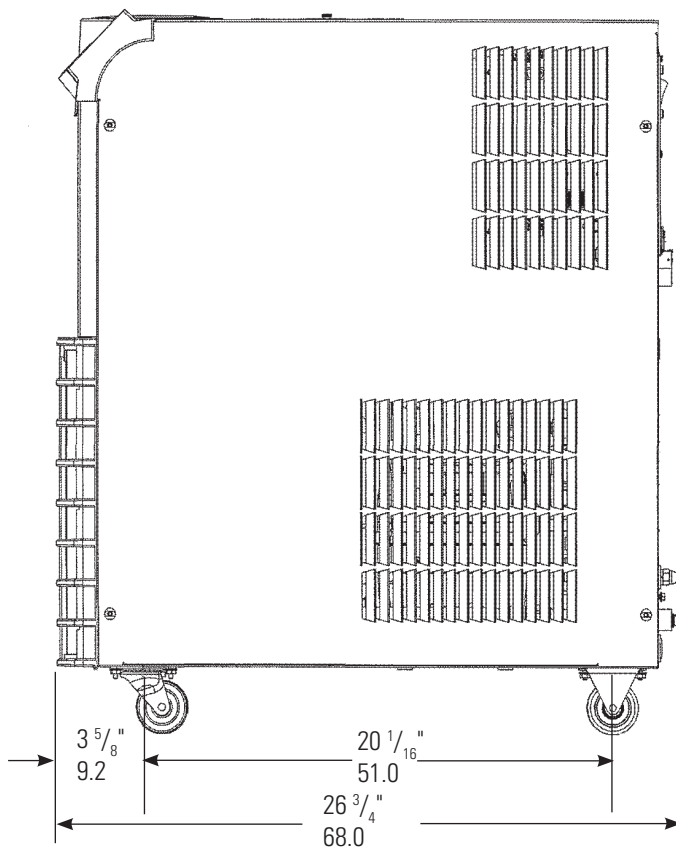

• Thermo Fisher Scientific reserves the right to change specifications without notice.

**ThermoFlex2500**

Process discharge for chillers with optional flow transducer or Internal pressure regulator adjustment (Optional)  
1/2" FNPT Stainless Steel

Process discharge fluid connection  
1/2" FNPT Cast Bronze

Process fluid return connection  
1/2" FNPT Stainless Steel

Optional 1/2" Auxiliary and 1/4" Auto-Refill Ports

Rear View

See Section 3 for additional plumbing information.



Process fluid drain (1/4" FNPT) Riton

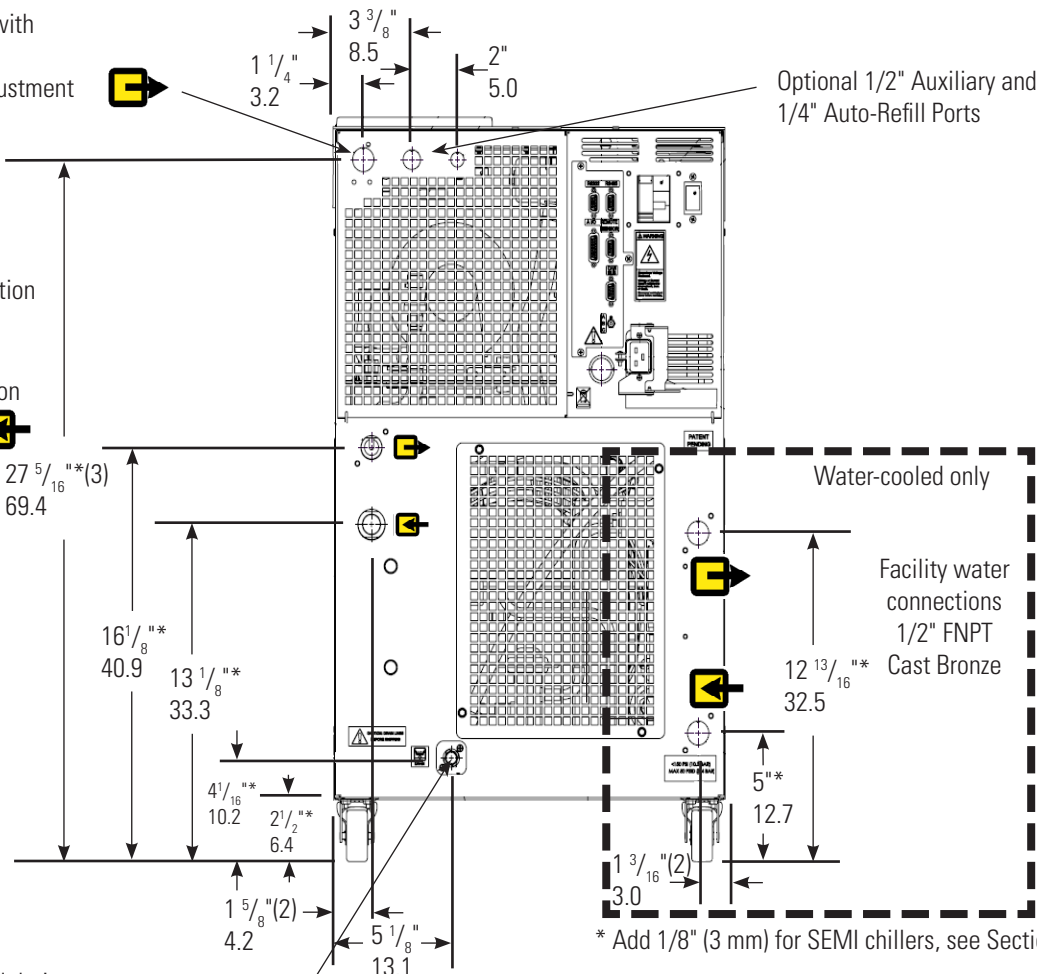

Top View

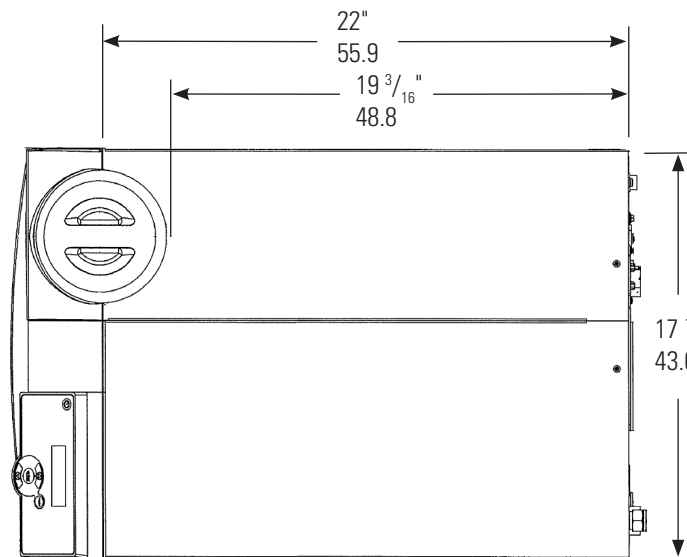

Shipping crate dimensions (approximate):  
23" (58 cm) wide  
36" (91 cm) tall  
40" (102 cm) deep

- Thermo Fisher Scientific reserves the right to change specifications without notice.

**ThermoFlex3500/5000**  
**Dimensions**  
 (inches/centimeters)

Front View

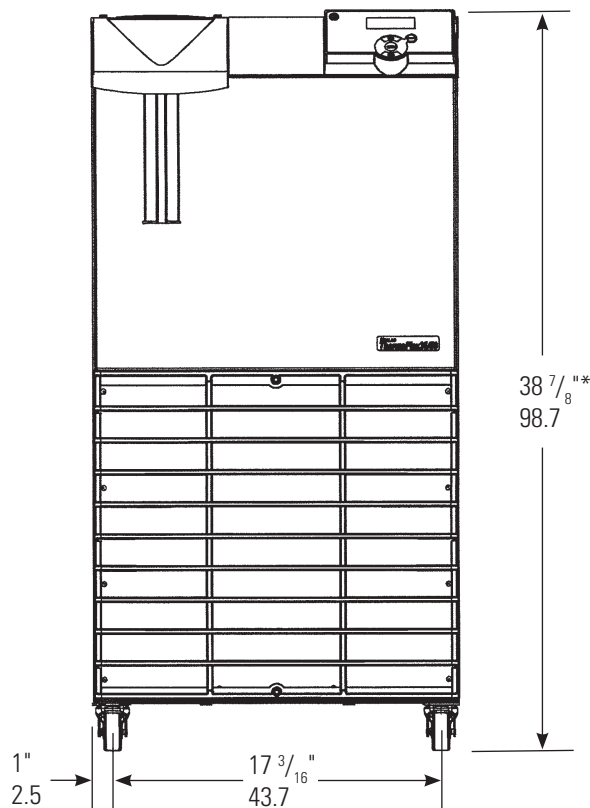

\* Add 1/8" (3 mm) for SEMI chillers, see Section 5.

Side View

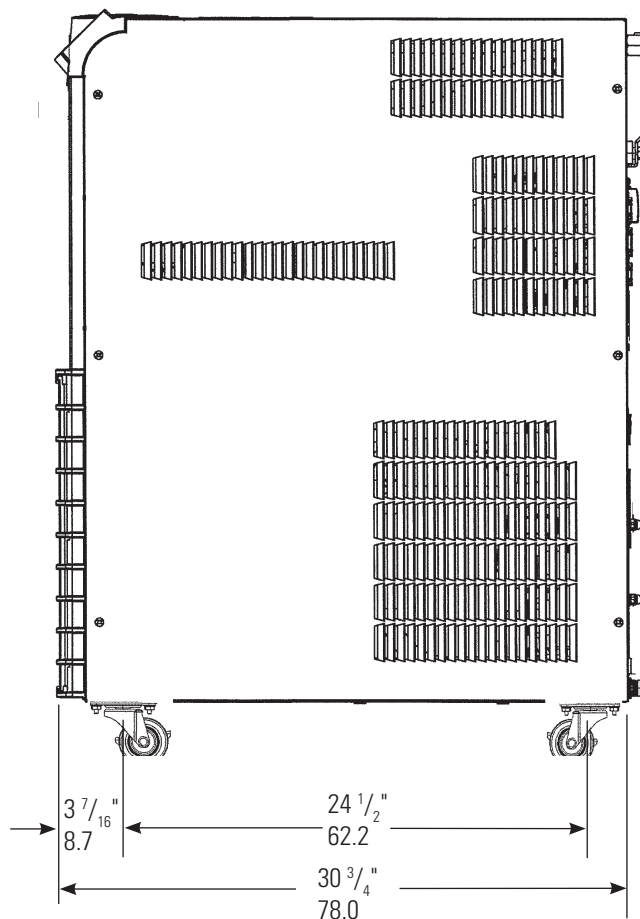

• Thermo Fisher Scientific reserves the right to change specifications without notice.

**ThermoFlex3500/5000**

Process discharge for chillers with optional flow transducer and P1, P2 & T1 pumps  
or  
Internal pressure regulator adjustment (Optional P1/MD1, P2/MD2 & T1 only)

1/2" FNPT Stainless Steel

Process discharge connection  
Cast Bronze

A P3, P4 pumps 3/4" FNPT  
B P1/MD1, P2/MD2, T1 pumps  
1/2" FNPT

Process return connection  
Stainless Steel  
P3, P4 pumps 3/4" FNPT  
P1/MD1, P2/MD2, T1 pumps  
1/2" FNPT

See Section 3 for additional plumbing information.

Rear View

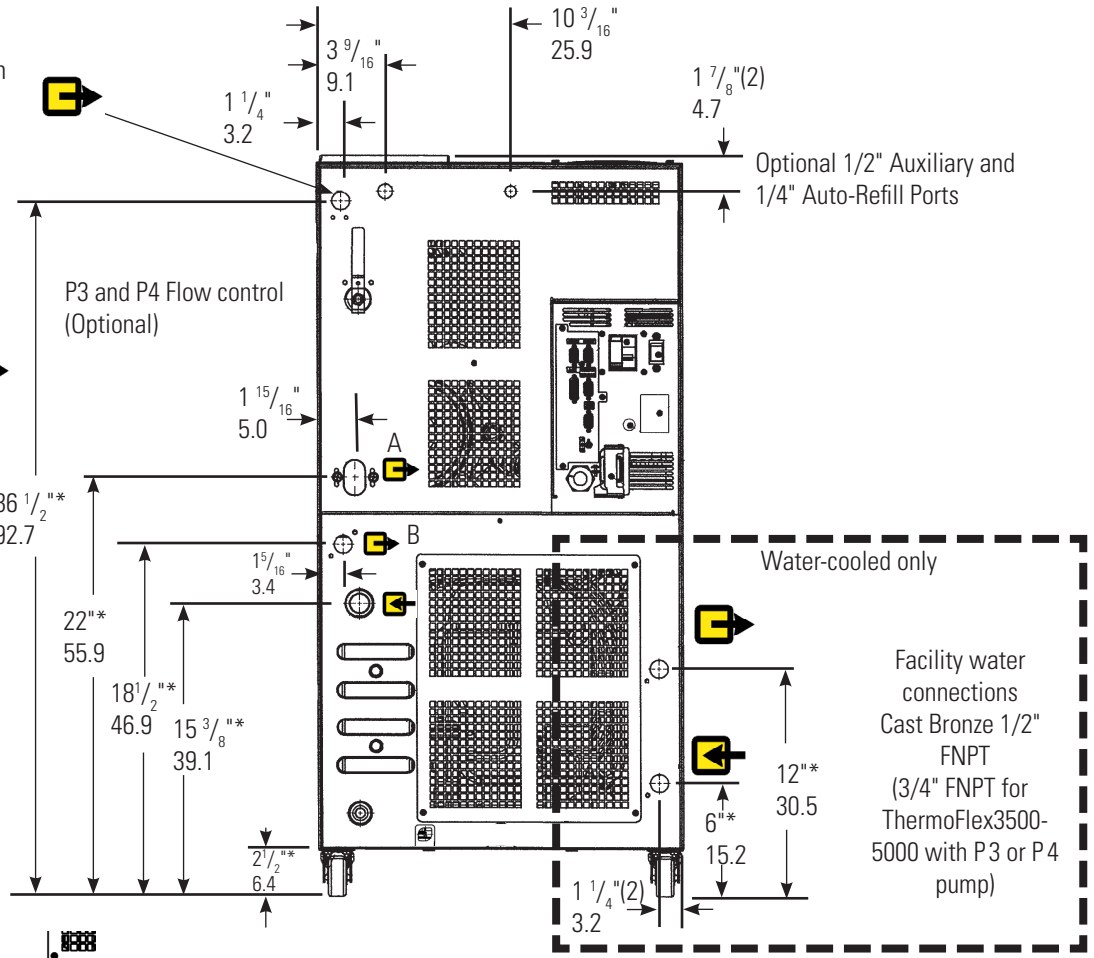

\* Add 1/8" (3 mm) for SEMI chillers, see Section 5.

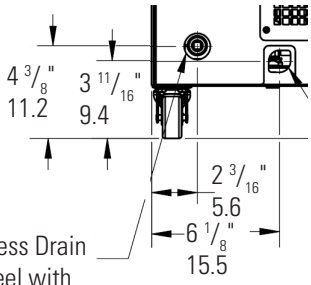

1/4" MPT Riton connector (P1/MD1, P2/MD2 and TU1 pumps only)

1/4" FPT Process Drain  
Stainless Steel with  
Brass plug  
(P3, P4 pumps only)

Top View

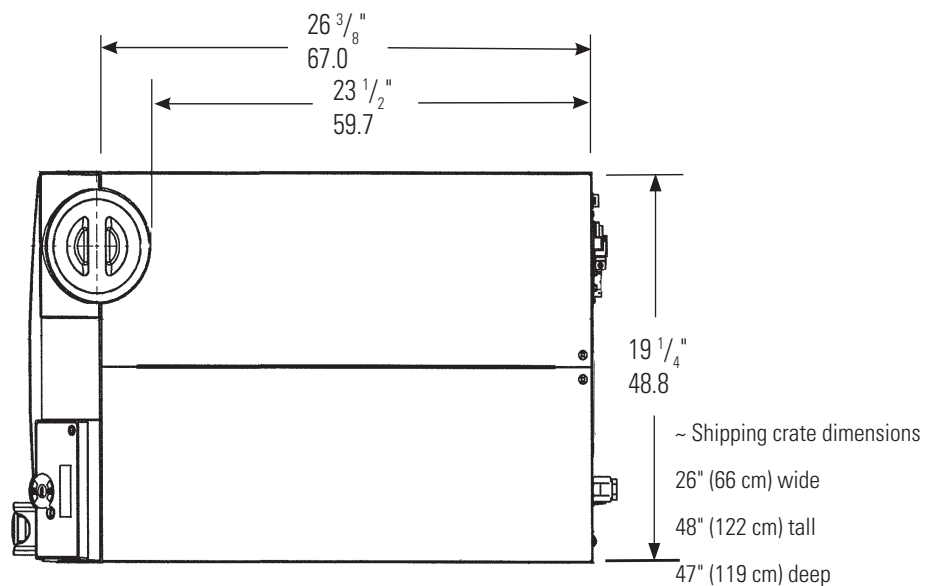

• Thermo Fisher Scientific reserves the right to change specifications without notice.

**ThermoFlex7500/10000**  
**Dimensions**  
 (inches/centimeters)

Side View

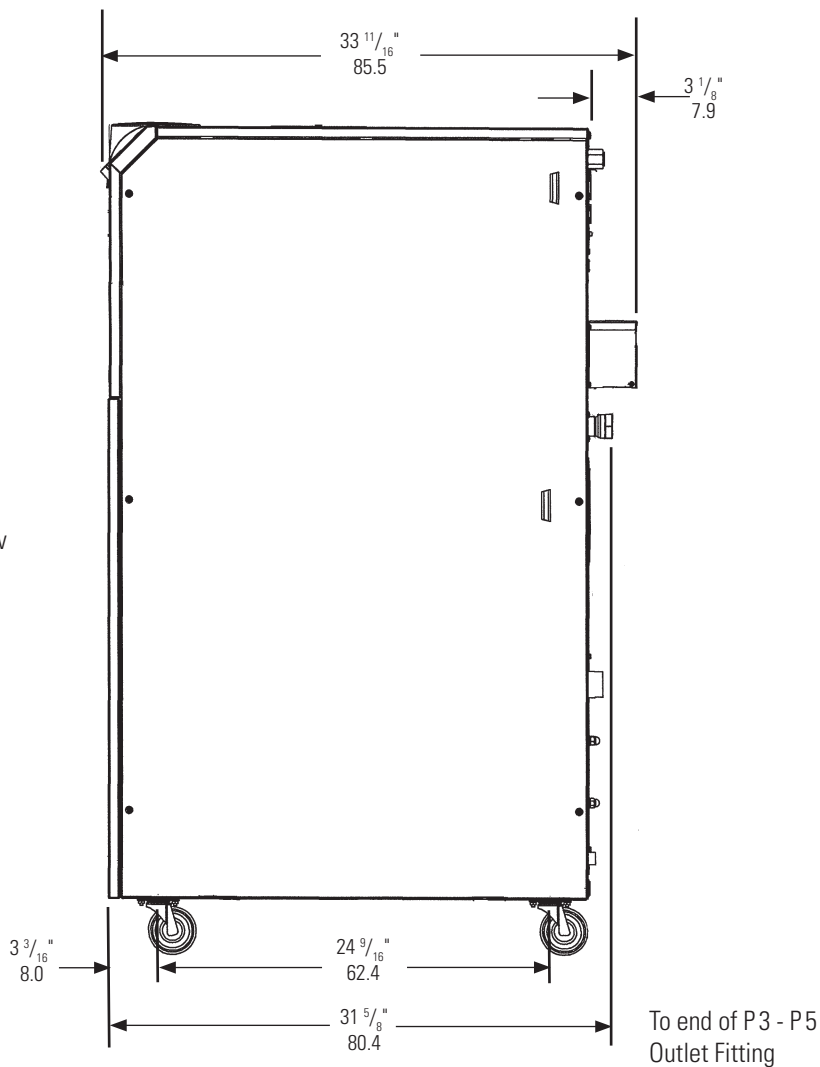

Top View

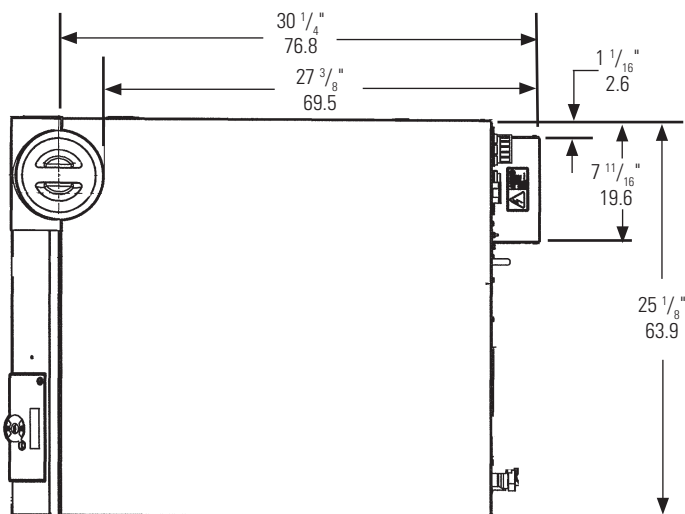

Air-cooled shipping crate dimensions (approximate):

35 3/4" (91 cm) wide

61 1/2" (156 cm) tall

46 3/8" (118 cm) deep

Water-cooled shipping crate dimensions (approximate):

35 3/4" (91 cm) wide

55 1/2" (141 cm) tall

46 3/8" (118 cm) deep

- Thermo Fisher Scientific reserves the right to change specifications without notice.

**ThermoFlex7500/10000**

Rear View  
(Air-Cooled)

Process Discharge   
P2/MD2 = 1/2" FNPT  
Cast Bronze  
P3 - P5, T5= 1" FNPT  
Wrought Copper

Process Return  
Stainless Steel  
P2/MD2 = 1/2" FNPT  
P3 - P5, T5 = 1" FNPT 

See Section 3 for  
additional plumbing  
information.

Process fluid drain (1/4" FNPT)  
Stainless Steel with Brass plug or  
a Riton connector



Rear View  
(Water-Cooled)

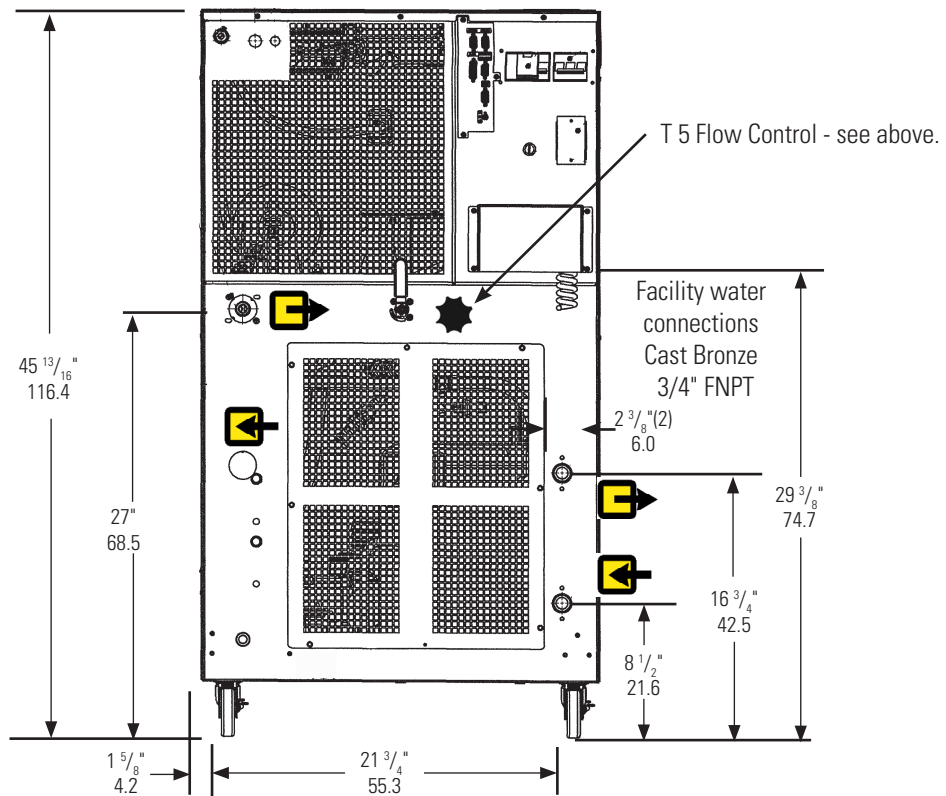
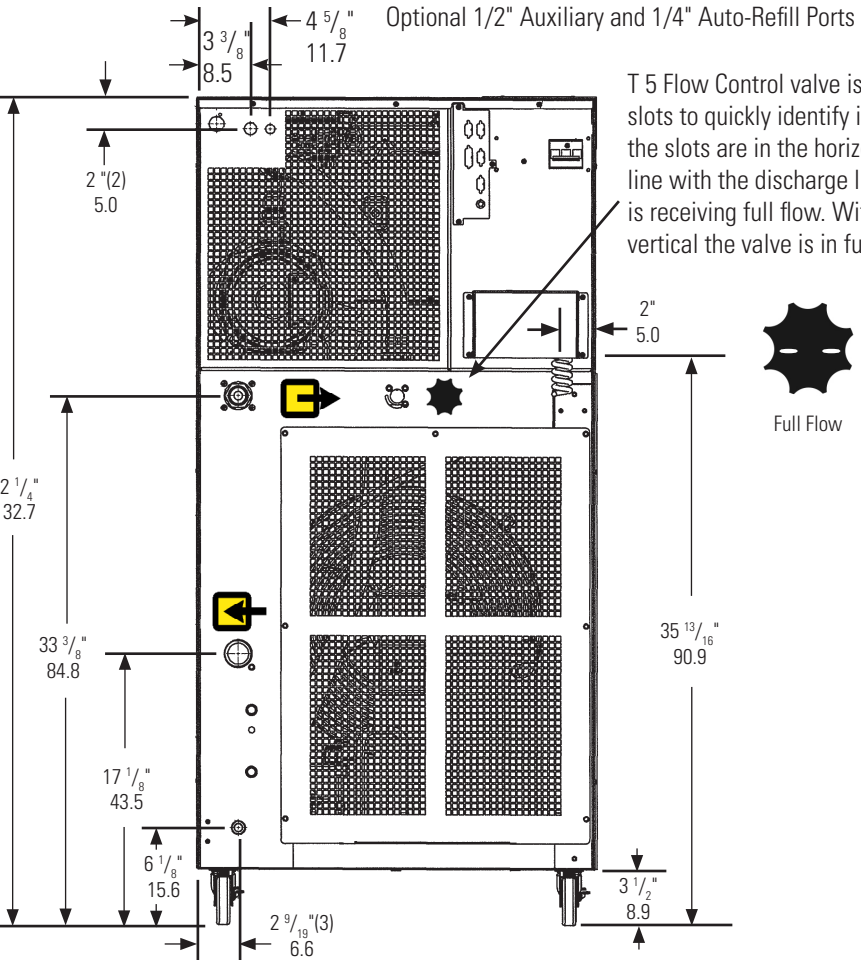

**ThermoFlex15000/20000/24000**

**Dimensions**

(inches/centimeters)

Front View

For ThermoFlex24000

Air-Cooled Chillers

58 <sup>5</sup>/<sub>8</sub>"

148.9

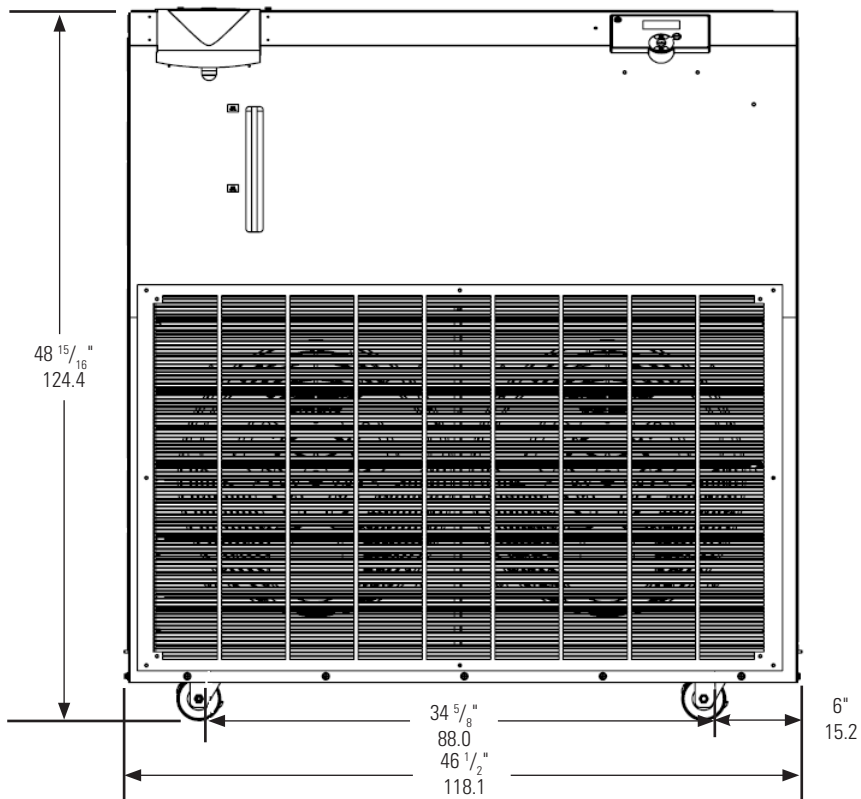

Side View

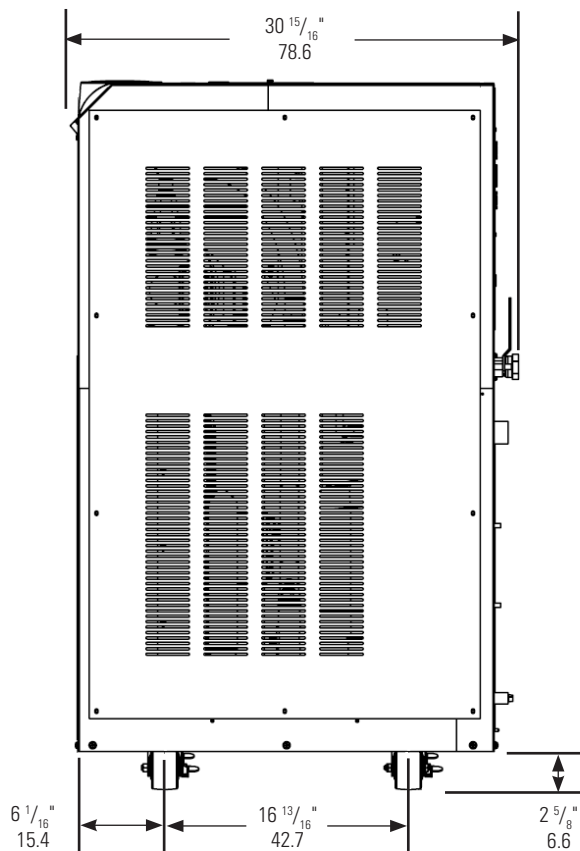

- Thermo Fisher Scientific reserves the right to change specifications without notice.



**ThermoFlex15000/20000/24000**

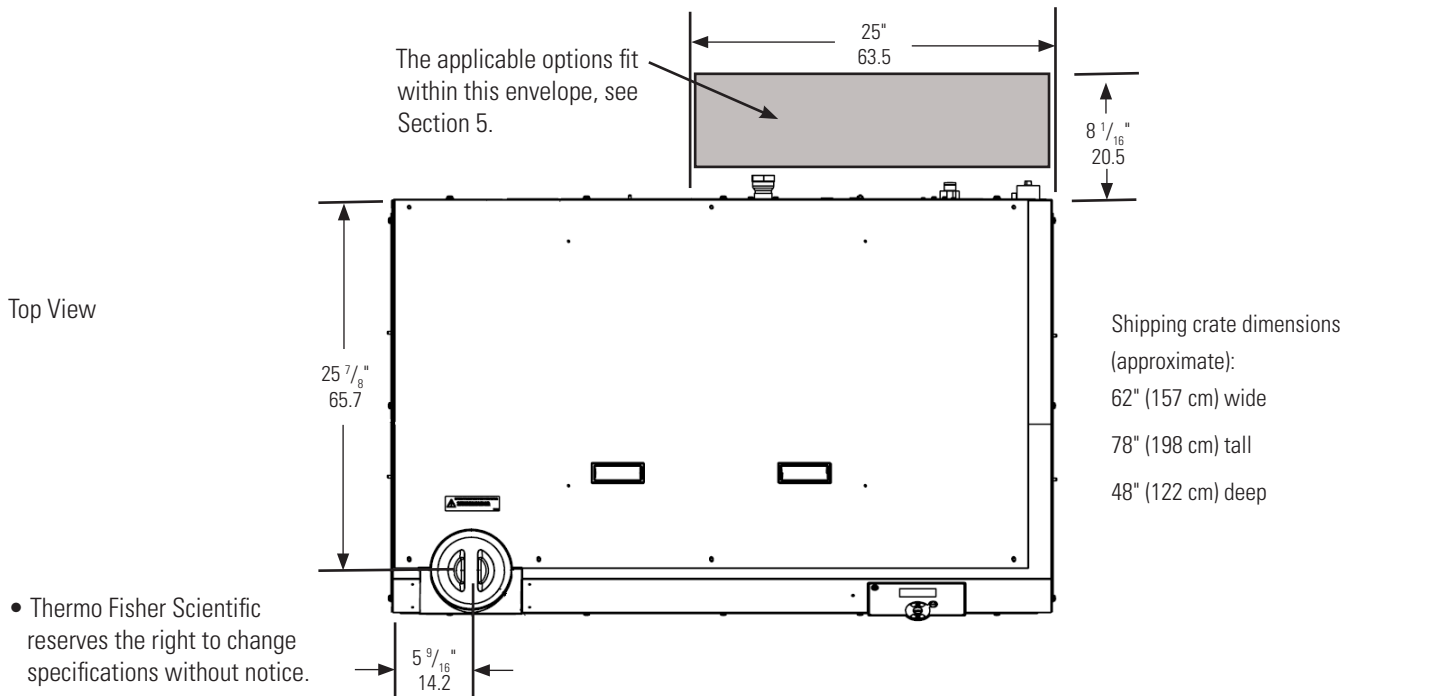
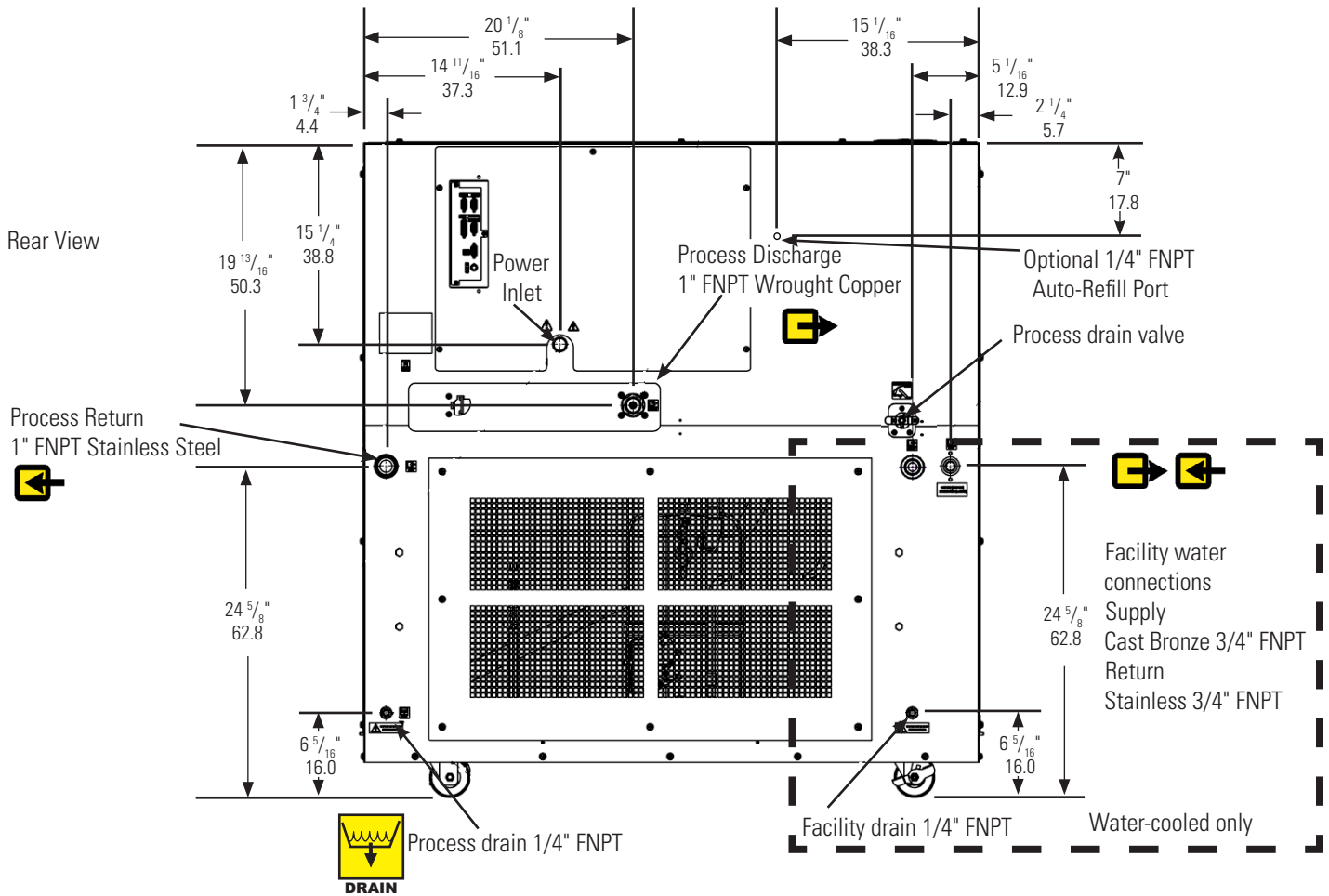

• Thermo Fisher Scientific reserves the right to change specifications without notice.



## Section 3 Installation

### Site Requirements

Ambient Temperature Range*	10°C to 40°C (50°F to 104°F)
Relative Humidity Range	10% to 80% (non-condensing)
Operating Altitude*	Sea Level to 8000 feet (2438 meters)
Overvoltage Category	II
Pollution Degree	2
Degree of Protection	IP 20

\*Because of the decrease in air density, maximum temperature for the air entering an air-cooled ThermoFlex is reduced by 1°C per 1,000 feet above sea level. In addition, cooling capacity is reduced 1.2% per 1,000 feet above sea level.



**Never place the chiller in a location where excessive heat, moisture, inadequate ventilation, or corrosive materials are present. ▲**

**Note** Refer to the nameplate information on the rear of the chiller. ▲

Air-cooled chillers retain their full rated capacity at 20°C setpoint in ambient temperatures up to 25°C (77°F). For ambient temperatures above 25°C please de-rate the cooling capacity 3% for every 1°C above 25°C (77°F), up to a maximum ambient temperature of 40°C (104°F). Note that when operating at a process temperature lower than 20°C the de-rate percentage may increase due to additional gains from losses to ambient.

**Note** Depending on the setpoint and ambient temperatures, there may be a heat gain or loss through the plumbing resulting in a variation from setpoint temperature at the application inlet. Applications with large temperature variations between ambient and setpoint temperatures, and/or long plumbing lengths, may require additional insulation. ▲

ThermoFlex2500 air-cooled chillers have a two-speed fan. Should the chiller's internal ambient temperature reach 50°C for 30 seconds, or reach 53°C, the fan speed will switch from slow speed to high speed to maintain internal temperatures within acceptable limits. When the temperature reaches 44°C or below for at least 15 minutes the speed will return to low. When in high speed the chiller's decibel level increases significantly.

**Note** High speed is required for the chiller to achieve its 2500 watt cooling capacity. At high-end operating conditions the fan can be set to run at high speed all the time using the controller's Setup Loop, see Section 4. ▲

Chillers installed below the end-user application may enable system fluid to drain back into the chiller and cause spillage. Thermo Fisher offers an anti-drainback kit to prevent any spillage, see Section 5.

Air-cooled chillers can be installed with both sides blocked, or one side and the rear. See Figure 3-1. The front of the chiller needs a minimum clearance of 24". Air will enter the front and exit through the sides and rear.

Having two sides blocked can impact the chiller's performance due to changes in air flow. If your installation requires two blocked sides please ensure that the following requirements are met:

Process Setpoint Temperature: Below 30°C (86°F)

Ambient: Below 40°C (104°F)

Before operating the chiller in conditions outside any of those listed on this page please contact Thermo Fisher Scientific's Sales, Service and Customer Support to review your installation.

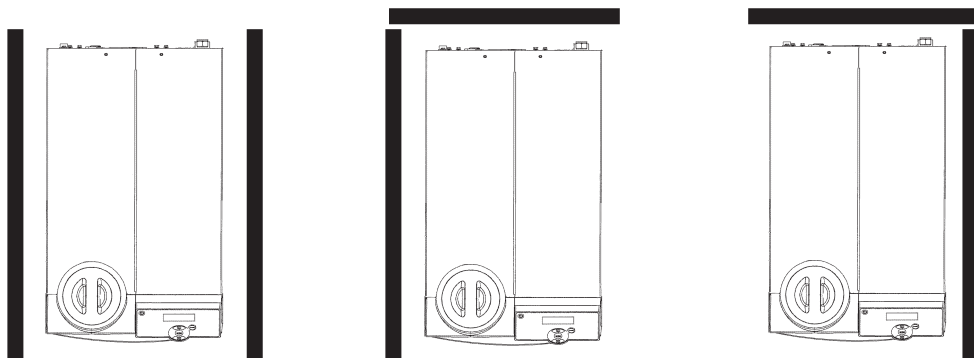

**Figure 3-1** Minimum Clearance

## Electrical Requirements



The chiller's construction provides protection against the risk of electrical shock by grounding appropriate metal parts. The protection will not function unless the power cord is connected to a properly grounded outlet. It is the user's responsibility to assure a proper ground connection is provided. ▲

The chiller must be installed in accordance with the National Electrical Code and the with reference to the information on the chiller's nameplate located on the rear.

Locate the chiller so it is near, and has easy access to, its disconnecting device.

The user is responsible to ensure that the line cord provided meets local electrical codes. If not, contact qualified installation personnel.

The chiller is intended for use on a dedicated outlet. The ThermoFlex has an internal circuit protection that is equivalent (approximately) to the branch circuit rating. This is to protect the ThermoFlex, and is not intended as a substitute for branch circuit protection.

Electrical Service Requirements (Standard chillers):

<b>ThermoFlex900</b>	<b>Voltage ±10%</b>	<b>Frequency</b>	<b>Phase</b>	<b>Branch Circuit Requirements</b>	<b>Line Cord Plug</b>
	100 VAC	50 Hz	1Ø	15A	5-15P
	115 VAC	60 Hz	1Ø	15A	5-15P
	200 VAC	50 Hz	1Ø	15A	6-15P
	208-230 VAC	60 Hz	1Ø	15A	6-15P
	230 VAC	50 Hz	1Ø	*16A <sup>1</sup> , 15A <sup>2</sup> , 13A <sup>3</sup>	-
<b>ThermoFlex1400</b>	<b>Voltage ±10%</b>	<b>Frequency</b>	<b>Phase</b>	<b>Branch Circuit Requirements</b>	<b>Line Cord Plug</b>
	100 VAC	50 Hz	1Ø	20A	5-20P
	115 VAC	60 Hz	1Ø	20A	5-20P
	200 VAC	50 Hz	1Ø	15A	6-15P
	208-230 VAC	60 Hz	1Ø	15A	6-15P
	230 VAC	50 Hz	1Ø	*16A <sup>1</sup> , 15A <sup>2</sup> , 13A <sup>3</sup>	-
<b>ThermoFlex2500</b>	<b>Voltage ±10%</b>	<b>Frequency</b>	<b>Phase</b>	<b>Branch Circuit Requirements</b>	<b>Line Cord Plug</b>
	200 VAC P1, P2 Pump	50 Hz	1Ø	15A	6-15P
	208-230 VAC P1, P2 Pump	60 Hz	1Ø	15A	6-15P
	200 VAC T1 Pump	50 Hz	1Ø	20A	6-20P
	208-230 VAC T1 Pump	60 Hz	1Ø	20A	6-20P
	230 VAC	50 Hz	1Ø	*16A <sup>1</sup> , 15A <sup>2</sup> , 13A <sup>3</sup>	-

\* Refer to Appendix A for country specific ratings.

Continued on next page.



## Electrical Service Requirements (Standard chillers):

<b>ThermoFlex3500/5000</b>	<b>Voltage ±10%</b>	<b>Frequency</b>	<b>Phase</b>	<b>Branch Circuit Requirements</b>	<b>Line Cord Plug</b>
	200 VAC P 1, P 2 Pump	50 Hz	1Ø	15A	6-15P
	200 VAC T 1, P 3 Pump	50 Hz	1Ø	20A	6-20P
	200 VAC P 4 Pump	50 Hz	1Ø	30A	6-30P
	208-230 VAC P 1, P 2 Pump	60 Hz	1Ø	15A	6-15P
	208-230 VAC T 1, P 3 Pump	60 Hz	1Ø	20A	6-20P
	208-230 VAC P 4 Pump	60 Hz	1Ø	30A	6-30P
	230 VAC P 1 - P 4 Pump	50 Hz	1Ø	*16A <sup>1</sup> , 15A <sup>2</sup> , 13A <sup>3</sup>	-

<b>ThermoFlex7500/10000 (Air-cooled)</b>	<b>Voltage ±10%</b>	<b>Frequency</b>	<b>Phase</b>	<b>MCA</b>	<b>MOPD</b>	<b>Line Cord Plug</b>
	200 VAC P 2 Pump	50 Hz	3Ø	16.5	30	L15-20P
	200 VAC P 3 Pump	50 Hz	3Ø	18.7	30	L15-30P
	200 VAC P 5 Pump	50 Hz	3Ø	22.3	35	L15-30P
	200 VAC T 5 Pump	50 Hz	3Ø	17.3	30	L15-20P
	208-230 VAC P 2 Pump	60 Hz	3Ø	16.5	30	L15-20P
	208-230 VAC P 3 Pump	60 Hz	3Ø	18.7	30	L15-30P
	208-230 VAC P 5 Pump	60 Hz	3Ø	22.3	35	L15-30P
	208-230 VAC T 5 Pump	60 Hz	3Ø	17.3	30	L15-20P
	400 VAC P 2 Pump	50 Hz	3Ø	10.9	20	IEC309
	400 VAC P 3 Pump	50 Hz	3Ø	9.6	15	IEC309
	400 VAC P 5 Pump	50 Hz	3Ø	11.8	15	IEC309
	400 VAC T 5 Pump	50 Hz	3Ø	8.7	15	IEC309

<b>ThermoFlex7500/10000 (Water-cooled)</b>	<b>Voltage ±10%</b>	<b>Frequency</b>	<b>Phase</b>	<b>MCA</b>	<b>MOPD</b>	<b>Line Cord Plug</b>
	200 VAC P 2 Pump	50 Hz	3Ø	16.2	30	L15-20P
	200 VAC P 3 Pump	50 Hz	3Ø	18.4	30	L15-30P
	200 VAC P 5 Pump	50 Hz	3Ø	22.0	35	L15-30P
	200 VAC T 5 Pump	50 Hz	3Ø	17.0	30	L15-20P
	208-230 VAC P 2 Pump	60 Hz	3Ø	16.2	30	L15-20P
	208-230 VAC P 3 Pump	60 Hz	3Ø	18.4	30	L15-30P
	208-230 VAC P 5 Pump	60 Hz	3Ø	22.0	35	L15-30P
	208-230 VAC T 5 Pump	60 Hz	3Ø	17.0	30	L15-20P
	400 VAC P 2 Pump	50 Hz	3Ø	10.6	20	IEC309
	400 VAC P 3 Pump	50 Hz	3Ø	9.3	15	IEC309
	400 VAC P 5 Pump	50 Hz	3Ø	11.5	20	IEC309
	400 VAC T 5 Pump	50 Hz	3Ø	8.4	15	IEC309

**MCA** = Minimum Current Ampacity

**MOPD** = Maximum Overcurrent Protective Device

Values reflect those on the nameplate located on the rear of the chiller.

Continued on next page.

<b>ThermoFlex15000/20000 (Air-cooled)</b>	<b>Voltage ±10%</b>	<b>Frequency</b>	<b>Phase</b>	<b>MCA</b>	<b>MOPD</b>	<b>Line Cord Plug</b>
	208-230 VAC P 3 Pump	60 Hz	3∅	32.2	60	Hard wire
	208-230 VAC P 5 Pump	60 Hz	3∅	35.8	60	Hard wire
	400 VAC P 3 Pump	50 Hz	3∅	15.9	30	Hard wire
	400 VAC P 5 Pump	50 Hz	3∅	18.1	30	Hard wire

<b>ThermoFlex15000/20000 (Water-cooled)</b>	<b>Voltage ±10%</b>	<b>Frequency</b>	<b>Phase</b>	<b>MCA</b>	<b>MOPD</b>	<b>Line Cord Plug</b>
	208-230 VAC P 3 Pump	60 Hz	3∅	28.7	50	Hard wire
	208-230 VAC P 5 Pump	60 Hz	3∅	32.3	60	Hard wire
	400 VAC P 3 Pump	50 Hz	3∅	14.5	25	Hard wire
	400 VAC P 5 Pump	50 Hz	3∅	16.7	30	Hard wire

<b>ThermoFlex24000 (Air-cooled)</b>	<b>Voltage ±10%</b>	<b>Frequency</b>	<b>Phase</b>	<b>MCA</b>	<b>MOPD</b>	<b>Line Cord Plug</b>
	208-230 VAC P 3 Pump	60 Hz	3∅	43.9	70	Hard wire
	208-230 VAC P 5 Pump	60 Hz	3∅	52.9	90	Hard wire
	400 VAC P 3 Pump	50 Hz	3∅	20.1	35	Hard wire
	400 VAC P 5 Pump	50 Hz	3∅	22.3	40	Hard wire

<b>ThermoFlex24000 (Water-cooled)</b>	<b>Voltage ±10%</b>	<b>Frequency</b>	<b>Phase</b>	<b>MCA</b>	<b>MOPD</b>	<b>Line Cord Plug</b>
	208-230 VAC P 3 Pump	60 Hz	3∅	37.1	70	Hard wire
	208-230 VAC P 5 Pump	60 Hz	3∅	40.7	70	Hard wire
	400 VAC P 3 Pump	50 Hz	3∅	18.8	35	Hard wire
	400 VAC P 5 Pump	50 Hz	3∅	21.0	35	Hard wire

Electrical Service Requirements (Variable voltage chillers):

<b>ThermoFlex900</b>	<b>Voltage ±10%</b>	<b>Frequency</b>	<b>Phase</b>	<b>Branch Circuit Requirements</b>	<b>Line Cord Plug</b>
	115 VAC	60 Hz	1∅	15A	5-15P*
	100 VAC	50/60 Hz	1∅	15A	5-15P*

<b>ThermoFlex1400</b>	<b>Voltage ±10%</b>	<b>Frequency</b>	<b>Phase</b>	<b>Branch Circuit Requirements</b>	<b>Line Cord Plug</b>
	115 VAC	60 Hz	1∅	20A	-
	100 VAC	50/60 Hz	1∅	20A	-

\* United States and Japan only. All other plugs are country specific.

For installation information on variable voltage chillers refer to Appendix B. Refer to the nameplate label located on the rear of the chiller for specific electrical requirements.

Electrical Service Requirements (Global Voltage chillers):

<b>ThermoFlex900</b>	<b>Voltage ±10%</b>	<b>Frequency</b>	<b>Phase</b>	<b>Branch Circuit Requirements</b>	<b>Line Cord Plug</b>
	200/208/230 VAC	60 Hz	1Ø	15A	-
	200/230 VAC	50 Hz	1Ø	**16A <sup>1</sup> , 15A <sup>2</sup> , 13A <sup>3</sup>	-

<b>ThermoFlex1400</b>	<b>Voltage ±10%</b>	<b>Frequency</b>	<b>Phase</b>	<b>Branch Circuit Requirements</b>	<b>Line Cord Plug</b>
	200/208/230 VAC	60 Hz	1Ø	15A	-
	200/230 VAC	50 Hz	1Ø	**16A <sup>1</sup> , 15A <sup>2</sup> , 13A <sup>3</sup>	-

<b>ThermoFlex2500</b>	<b>Voltage ±10%</b>	<b>Frequency</b>	<b>Phase</b>	<b>Branch Circuit Requirements</b>	<b>Line Cord Plug</b>
	200 VAC T 1 Pump	60 Hz	1Ø	15A	-
	208-230 VAC T 1 Pump	60 Hz	1Ø	20A	-
	230 VAC	50 Hz	1Ø	*16A <sup>1</sup> , 15A <sup>2</sup> , 13A <sup>3</sup>	-

<b>ThermoFlex3500/5000</b>	<b>Voltage ±10%</b>	<b>Frequency</b>	<b>Phase</b>	<b>Branch Circuit Requirements</b>	<b>Line Cord Plug</b>
	200/208-230 VAC P 1 P 3 Pump	50/60 Hz	1Ø	15A	-
	200/208-230 VAC T 1 P 3 Pump	50/60 Hz	1Ø	20A	-
	200/208-230 VAC P 4 Pump	50/60 Hz	1Ø	30A	Hard wired

<b>ThermoFlex7500/10000 (Air-cooled)</b>	<b>Voltage ±10%</b>	<b>Frequency</b>	<b>Phase</b>	<b>MCA</b>	<b>MOPD</b>	<b>Line Cord Plug</b>
	400 VAC P 2 Pump	50 Hz	3Ø	8.8	15	Hard wire
	400 VAC P 3 Pump	50 Hz	3Ø	10.1	20	Hard wire
	400 VAC P 5 Pump	50 Hz	3Ø	12.3	20	Hard wire
	400 VAC T 5 Pump	50 Hz	3Ø	9.1	15	Hard wire
	460 VAC P 2 Pump	60 Hz	3Ø	8.8	15	Hard wire
	460 VAC P 3 Pump	60 Hz	3Ø	10.1	20	Hard wire
	460 VAC P 5 Pump	60 Hz	3Ø	12.3	20	Hard wire
	460 VAC T 5 Pump	60 Hz	3Ø	9.1	15	Hard wire

<b>ThermoFlex7500/10000 (Water-cooled)</b>	<b>Voltage ±10%</b>	<b>Frequency</b>	<b>Phase</b>	<b>MCA</b>	<b>MOPD</b>	<b>Line Cord Plug</b>
	400 VAC P 2 Pump	50 Hz	3Ø	8.4	15	Hard wire
	400 VAC P 3 Pump	50 Hz	3Ø	9.7	20	Hard wire
	400 VAC P 5 Pump	50 Hz	3Ø	11.9	20	Hard wire
	400 VAC T 5 Pump	50 Hz	3Ø	8.8	15	Hard wire
	460 VAC P 2 Pump	60 Hz	3Ø	8.4	15	Hard wire
	460 VAC P 3 Pump	60 Hz	3Ø	9.7	20	Hard wire
	460 VAC P 5 Pump	60 Hz	3Ø	11.9	20	Hard wire
	460 VAC T 5 Pump	60 Hz	3Ø	8.8	15	Hard wire

Continued on next page.

<b>ThermoFlex15000/20000 (Air-cooled)</b>	<b>Voltage ±10%</b>	<b>Frequency</b>	<b>Phase</b>	<b>MCA</b>	<b>MOPD</b>	<b>Line Cord Plug</b>
	400 VAC P 3 Pump	50 Hz	3Ø	16.2	30	Hard wire
	400 VAC P 5 Pump	50 Hz	3Ø	18.4	30	Hard wire
	460 VAC P 3 Pump	60 Hz	3Ø	16.2	30	Hard wire
	460 VAC P 5 Pump	60 Hz	3Ø	18.4	30	Hard wire

<b>ThermoFlex15000/20000 (Water-cooled)</b>	<b>Voltage ±10%</b>	<b>Frequency</b>	<b>Phase</b>	<b>MCA</b>	<b>MOPD</b>	<b>Line Cord Plug</b>
	400 VAC P 3 Pump	50 Hz	3Ø	14.5	25	Hard wire
	400 VAC P 5 Pump	50 Hz	3Ø	16.7	30	Hard wire
	460 VAC P 3 Pump	60 Hz	3Ø	14.5	25	Hard wire
	460 VAC P 5 Pump	60 Hz	3Ø	16.7	30	Hard wire

<b>ThermoFlex24000 (Air-cooled)</b>	<b>Voltage ±10%</b>	<b>Frequency</b>	<b>Phase</b>	<b>MCA</b>	<b>MOPD</b>	<b>Line Cord Plug</b>
	400 VAC P 3 Pump	50 Hz	3Ø	20.1	35	Hard wire
	400 VAC P 5 Pump	50 Hz	3Ø	22.3	40	Hard wire
	460 VAC P 3 Pump	60 Hz	3Ø	20.1	35	Hard wire
	460 VAC P 5 Pump	60 Hz	3Ø	22.3	40	Hard wire

<b>ThermoFlex24000 (Water-cooled)</b>	<b>Voltage ±10%</b>	<b>Frequency</b>	<b>Phase</b>	<b>MCA</b>	<b>MOPD</b>	<b>Line Cord Plug</b>
	400 VAC P 3 Pump	50 Hz	3Ø	18.8	35	Hard wire
	400 VAC P 5 Pump	50 Hz	3Ø	21.0	35	Hard wire
	460 VAC P 3 Pump	60 Hz	3Ø	18.8	35	Hard wire
	460 VAC P 5 Pump	60 Hz	3Ø	21.0	35	Hard wire

\*\* Chillers selected for 230 VAC operation have a range of -10% to +7%. Refer to Appendix A for country specific ratings.

For installation information on global voltage chillers refer to Appendix B. Refer to the nameplate label located on the rear of the chiller for specific electrical requirements.

**MCA** = Minimum Current Ampacity

**MOPD** = Maximum Overcurrent Protective Device

Values reflect those on the nameplate located on the rear of the chiller .

# Hard Wire Installation



For personal safety and equipment reliability, only a qualified technician should perform the following procedure. ▲

**Note** The technician is responsible for installing circuit protection for incoming power. Before wiring consult the nameplate on the rear of the chiller. Ensure installation is in accordance with the National Electrical Code and any other applicable country and local codes. ▲

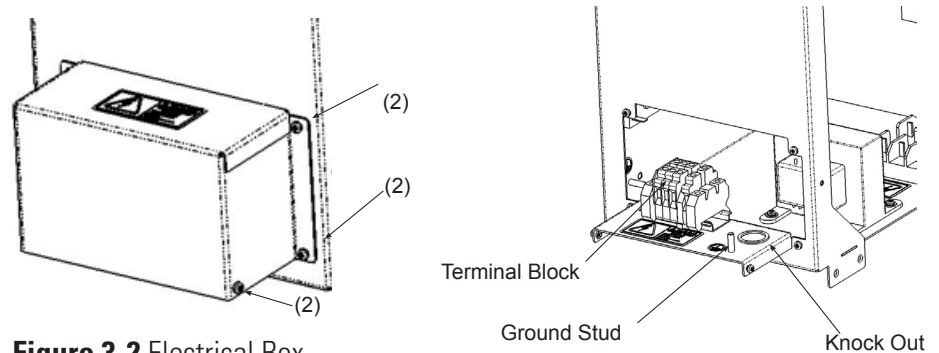

**Figure 3-2** Electrical Box

### For ThermoFlex900 through 10000 chillers

- Remove the six screws securing the electrical box cover to the chiller.
- Remove the double knock out ( $\frac{7}{8}$ " and  $1\frac{3}{32}$ ").
- Insert the cable through the hole.
- Refer to the label in the electrical box to configure your chiller, see Figure 3-3.
- Secure the cable's ground wire to the ground stud.
- Reinstall the cover.

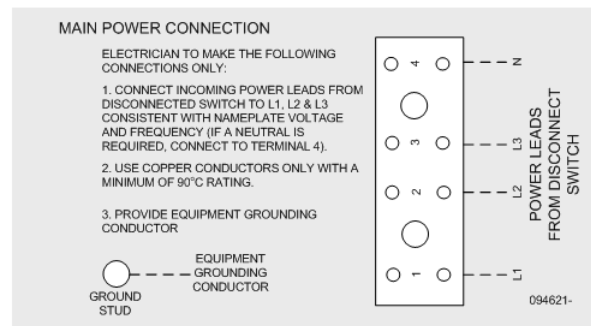

**Figure 3-3** Sample Label

### For ThermoFlex15000, 20000 and 24000 chillers

- Remove the five screws securing the electrical panel to the chiller.
- Refer to the label in the electrical box to configure your chiller, see Figure 3-3.
- Secure the cable's ground wire to the ground stud.
- Reinstall the panel.

## Plumbing Requirements



Ensure that all shipping plugs are removed before installation.



Never connect the process fluid lines to your facility water supply or any pressurized liquid source. ▲



To prevent damage to the chiller's plate exchanger, centrifugal pumps require a 4.0 gpm (15.1 lpm) minimum flow rate. ▲

P1 and P2 pumps are capable of producing 185 psig. Ensure your plumbing is rated to withstand this pressure at your operating temperature. An external pressure relief valve is available, see Section 5. ▲

**Note** Ensure your plumbing installation develops a back pressure to the ThermoFlex greater than 3 PSIG. Lower pressure will shut down the chiller. ▲

The process fluid connections are located on the rear of the chiller and are labeled (PROCESS OUTLET) and (PROCESS INLET).

### Process Fluid Connections (FNPT)

#### Outlet

ThermoFlex900 - 10000	P 1 P 2 T 0 T 1	1/2" cast bronze
ThermoFlex3500 - 5000	P 3 P 4	3/4" cast bronze
ThermoFlex7500 - 24000	P 3 P 5 T 5	1" wrought copper
Inlet - Same size as outlet		all connections stainless steel

### Supplied Adapters

P 1 P 2 T 0 T 1	1/2" x 3/8" polyethylene and 1/2" x 1/2" nylon
P 3 P 4	3/4 MPT x 1/2 barb PVC
P 3 P 5 T 5	1" MPT x 1" barb PVC and 1" MPT x 3/4" barb PVC

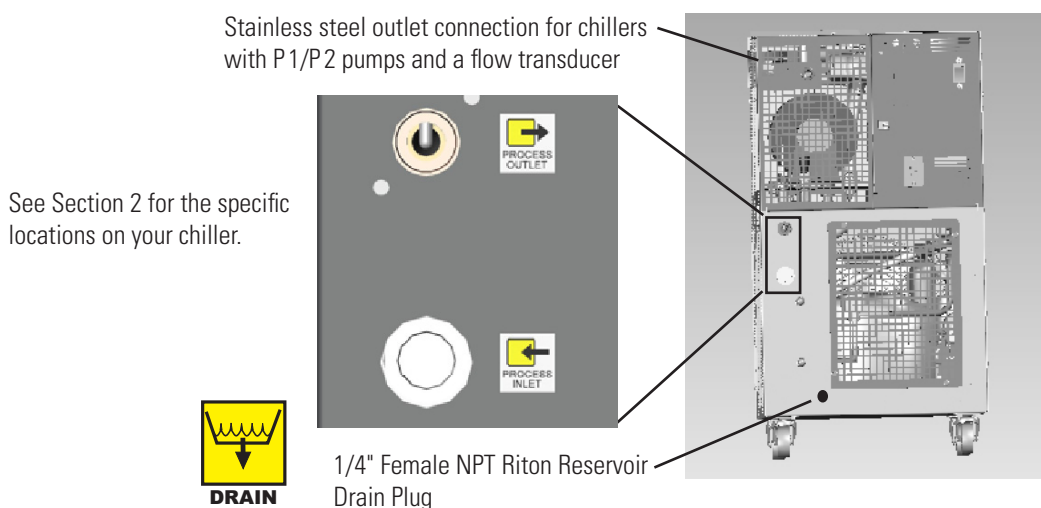



**Figure 3-4** Typical Plumbing Connections (1 of 2)

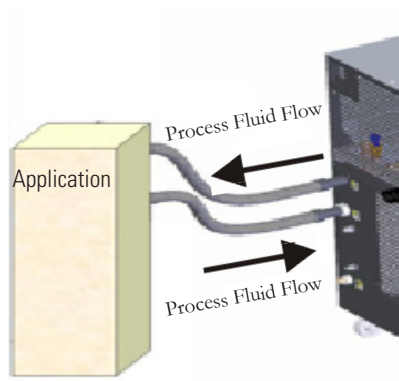







**Figure 3-4** Typical Plumbing Connections (2 of 2)

Connect the PROCESS OUTLET  to the fluid inlet on your application. Connect the PROCESS INLET  to the fluid outlet on your application. Ensure all connections are secure and that the proper sealant/lubricant for the fitting material is used. (If Teflon<sup>®</sup> tape is used, ensure the tape does not overhang the first thread as it could shred and get into the fluid.) Keep the distance between the chiller and the instrument being cooled as short as possible. Ensure tubing is straight and without bends. If diameter reductions are required, make them at the inlet and outlet of your application, not at the ThermoFlex.

**Water-cooled Chillers only**

The facility water plumbing connections are also located on the rear and are labeled  FACILITY INLET and  FACILITY OUTLET. The connections are 1/2" Female NPT for ThermoFlex900 - 5000, 3/4" Female NPT for ThermoFlex7500 - 24000. Both connections for ThermoFlex900 to 10000 are cast bronze. The supply connections for ThermoFlex15000 to 24000 are cast bronze, the return connections are stainless steel.

Connect the  FACILITY INLET to your facility water supply. Connect the  FACILITY OUTLET to your facility water return or drain. Ensure all connections are secure and that the proper sealant/lubricant for the fitting material is used. (If Teflon<sup>®</sup> tape is used, ensure the tape does not overhang the first thread as it could shred and get into the fluid.)

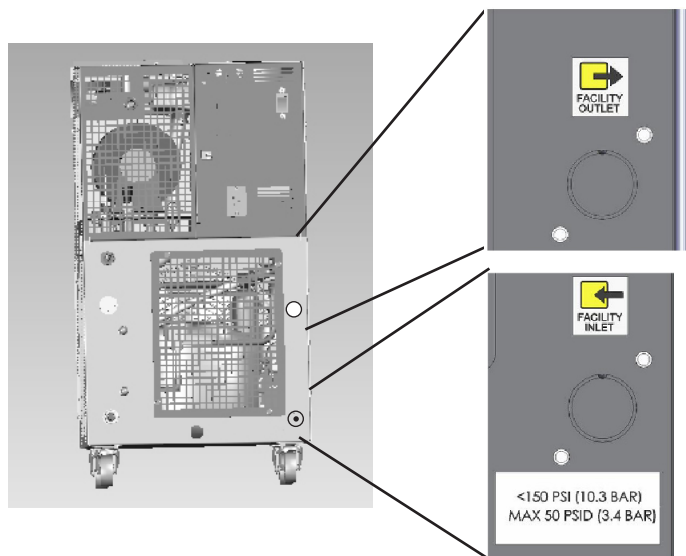

See Section 2 for the specific locations on your chiller.

**Figure 3-5** Typical Plumbing Connections, Water-cooled Chillers

## Process Fluid Requirements



Do not use automotive antifreeze. Commercial antifreeze contains silicates that can damage the pump seals. Use of any fluid not listed below will void the manufacturer's warranty. ▲

Approved fluids are:

- Filtered/Single Distilled water
- 0 - 75% Laboratory Grade Ethylene Glycol/Water
- 0 - 75% Laboratory Grade Propylene Glycol/Water
- Deionized water (3 MΩ-cm max, compensated)

For applications requiring resistivity greater than 1 meg-Ohm/cm please call and speak to an applications engineer for additional information.



Ethylene glycol (EG) is poisonous and flammable. Before using any fluid or performing maintenance where contact with the fluid is likely refer to the manufacturer's most current MSDS for handling precautions. ▲



EG is also hygroscopic, it will absorb water from its environment. This can affect the freezing point and boiling point of the fluid over time and may result in system failure. ▲



To prevent freezing/glazing of the plate exchanger, ThermoFlex7500 through 24000 chillers require the use of 50/50 EG/water or 50/50 PG/water below 10°C process temperature. ▲



When using a process fluid mixture of ethylene glycol and water or propylene glycol and water, check the fluid concentration and pH on a regular basis. Changes in concentration and pH can impact system performance. ▲



When using EG/water or PG/water, top-off with plain water. After top-off check the fluid concentration. ▲



Do not use a Deionization (DI) filter cartridge with Inhibited EG or Inhibited PG. A DI filter will remove inhibitors from the solution rendering the fluid ineffective against corrosion protection. Also, inhibitors increase fluid conductivity. ▲

## Compatibility with Approved Fluids

### Filtered/Single Distilled Water

Filtered drinking water and single distilled water are good choices for recirculating chillers because the filtering/distilling process used removes microorganisms that could create biological fouling as well as harmful particulates and excessive minerals that could cause deposits and scaling.

### Chlorine

Short term usage of tap water may not cause any adverse affects on the chiller or your application, but in the long term problems may arise. To help alleviate these problems Thermo Fisher Scientific recommends the use of chlorine.

The duration of time that chlorine remains in solution depends on factors such as water temperature, pH and availability of direct sunlight. We recommend maintaining chlorine levels at proper levels using chlorine test strips, generally 1 to 5 ppm is adequate.

For best results, maintain the pH of the fluid between 6.5 and 7.5. Do not add additional chlorine without first determining the concentration ratio that already exists in the fluid supply. Corrosion and degradation of the circulation components can result from concentration ratios that are too high. Contact our customer support for additional information.

### Deionized Water

Deionized water is water that has had its mineral ions removed using ion exchange resins. The purpose of this process is to remove the ions that allow electrical current to flow more easily through water. This helps to prevent electrical leaks to ground through the recirculating fluid. Deionized water is classified by the electrical resistance of the water, usually measured in  $M\Omega\text{-cm}$ , with pure water having a resistance of 18  $M\Omega\text{-cm}$ .

Deionized water is in an unbalanced state and will leach the missing ions from the materials it comes in contact with. The aggressive nature of this leaching can cause pitting on metal surfaces. Note that the deionizing process does not remove microorganisms. Because of this, we recommend deionized water only with applications that have it as a specified requirement.

In any case, only deionized water with 3  $M\Omega\text{-cm}$  resistivity maximum is approved for use in Thermo Fisher Scientific recirculating chillers.

### Recommended Biocides and Inhibitors

Thermo Fisher Scientific offers a biocide and inhibitor package Thermo 200 (Nalco) premixed with 5 gallons of water or as a kit to be added to water. No other biocide or inhibitor is recommended for use in our recirculating chillers.



**Biocides are corrosive and can cause irreversible eye damage and skin burns. They are harmful if inhaled, swallowed or absorbed through the skin. Refer to the manufacturer's most current MSDS. ▲**



**To prevent freezing/glazing of the plate exchanger, ThermoFlex7500 through 24000 chillers require the use of 50/50 EG/water or 50/50 PG/water below 10°C process temperature. ▲**

#### **Uninhibited Ethylene Glycol/Water**

Ethylene glycol is used to depress the freezing point of water and should only be used at temperatures where freeze point suppression is required. Ethylene glycol does not improve heat transfer and is not recommended for use as a biocide. Because glycols lower the surface tension of water and do not evaporate as readily as water, they may cause visible weepage past the pump seals. If weepage cannot be tolerated, seal-less, use magnetically driven pumps where available.

Uninhibited simply means that the glycol does not contain any additives to prevent corrosion. While uninhibited ethylene glycol is acceptable for use, the pH level must be closely monitored and the fluid may need to be replaced more often. Since all glycols produce acids in the presence of air and the fluid, change the glycol if the pH falls below 8. Note that litmus paper will not work to test the pH of ethylene glycol/water.

#### **Inhibited Ethylene Glycol/Water and Inhibited Propylene Glycol/Water**

Inhibited glycol can help protect the wetted metals within the cooling circuit from corrosion caused by poor water quality, ethylene glycol oxidation (low pH) and mixed metals (electrolysis). The inhibitor works by either leaving a barrier coating on metal surfaces to buffer them from the corrosive fluid or by creating an oxidized layer that protects the underlying metal (passivating).

Inhibited automotive glycols are never acceptable. They use either silicates or Organic Acid Technology (OAT) as the inhibitor and these components are not compatible with the polymers used in recirculating chillers including the pump seals and internal hoses.

Inhibitors may also accelerate pump seal wear and seal-less, Use magnetically driven pumps where available.

#### **Uninhibited Propylene Glycol/Water**

Propylene glycol does not transfer heat as well as ethylene glycol, but can be used when freeze point suppression is required as well as lower toxicity.

Propylene glycol does not function as a biocide and the pH needs to be maintained the same as with ethylene glycol as it also produces acid when oxidized.

## Additional Fluid Information

When using the ThermoFlex chiller to circulate through aluminum, use a compatible corrosion inhibitor to prevent galvanic corrosion.

Ensure fluid viscosity is 50 cSt or less at the lowest temperature used.

Visible pump weepage may occur when compatible glycols, oils or other additives are used. Pump weepage is considered as a normal operating condition of mechanical seal pumps.

## Process Water Quality and Standards

Process Fluid	Permissible (PPM)	Desirable (PPM)
<b>Microbiologicals</b> (algae, bacteria, fungi)	0	0
<b>Inorganic Chemicals</b>		
Calcium	<25	<0.6
Chloride	<25	<10
Copper	<1.3 0.020 ppm if fluid in contact with aluminum	<1.0
Iron	<0.3	<0.1
Lead	<0.015	0
Magnesium	<12	<0.1
Manganese	<0.05	<0.03
Nitrates\Nitrites	<10 as N	0
Potassium	<20	<0.3
Silicate	<25	<1.0
Sodium	<20	<0.3
Sulfate	<25	<1
Hardness	<17	<0.05
Total Dissolved Solids	<50	<10
<b>Other Parameters</b>		
pH	6.5-8.5	7-8
Resistivity	0.01*	0.05-0.1*

\* MΩ-cm (compensated to 25°C)

Unfavorably high total ionized solids (TIS) can accelerate the rate of galvanic corrosion. These contaminants can function as electrolytes which increase the potential for galvanic cell corrosion and lead to localized corrosion such as pitting. Eventually, the pitting will become so extensive that refrigerant will leak into the water reservoir.

As an example, raw water in the United States averages 171 ppm (of NaCl). The recommended level for use in a water system is between 0.5 to 5.0 ppm (of NaCl).

Recommendation: Initially fill the reservoir with distilled or 3 MΩ-cm deionized water. (It is acceptable to have the fluid drop to the other levels

over-time.) Do not use untreated tap water as the total ionized solids level may be too high. This will reduce the electrolytic potential of the water and prevent or reduce the galvanic corrosion observed.

## Facility Water Quality and Standards (water-cooled chillers)

Facility Water	Permissible (PPM)	Desirable (PPM)
<b>Microbiologicals</b> (algae, bacteria, fungi)	0	0
<b>Inorganic Chemicals</b>		
Calcium	<40	<0.6
Chloride	<250	<25
Copper	<1.3 0.020 ppm if fluid in contact with aluminum	<1.0
Iron	<0.3	<0.1
Lead	<0.015	0
Magnesium	<12	<0.1
Manganese	<0.05	<0.03
Nitrates/Nitrites	<10 as N	0
Potassium	<20	<0.3
Silicate	<25	<1.0
Sodium	<20	<0.3
Sulfate	<250	<50
Hardness	<17	<0.05
Total Dissolved Solids	<50	<10

**Note** A corrosion inhibitor is recommended if mixed metals are in the facility water loop. ▲



# Facility Water Requirements (water-cooled chillers)



Facility Water Maximum Inlet Pressure must not exceed 150 PSIG. ▲

Facility Water Maximum Pressure Differential must not exceed 50 PSID. ▲

(Pressure Differential = Inlet Pressure - Outlet Pressure)

**Note** Before using facility water that is above 35°C contact Thermo Fisher Scientific. ▲

The facility water must meet the following conditions for the chiller to maintain its full rated capacity.

### ThermoFlex1400

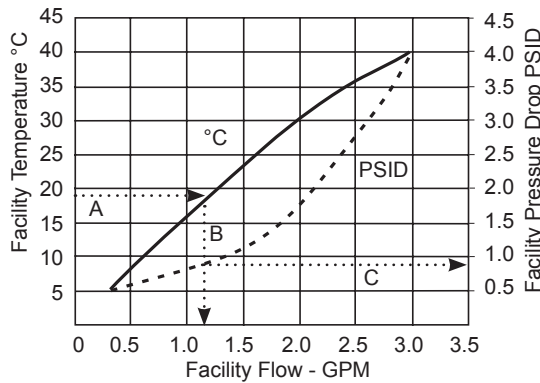

Example:  
Follow the .....► lines.  
Start with a known, e.g., facility water temperature.  
A - go across to temperature curve  
B - drop down to determine the minimum required facility flow.  
C - Where B crosses the PSID curve, go across to determine the minimum required PSID.

### ThermoFlex2500

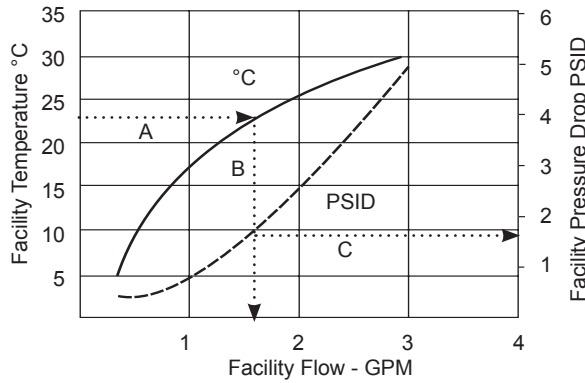

Example: See above.

### ThermoFlex3500/5000

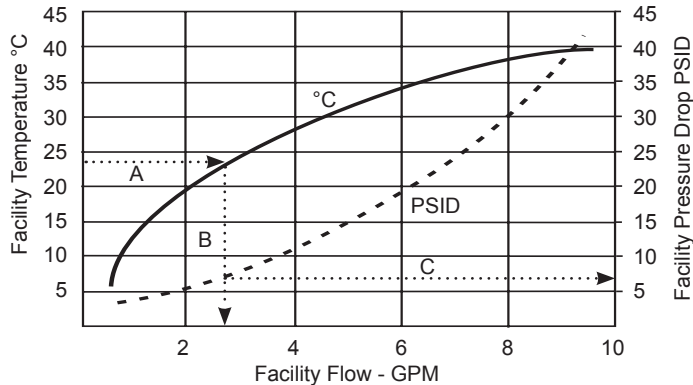

Example: See above.

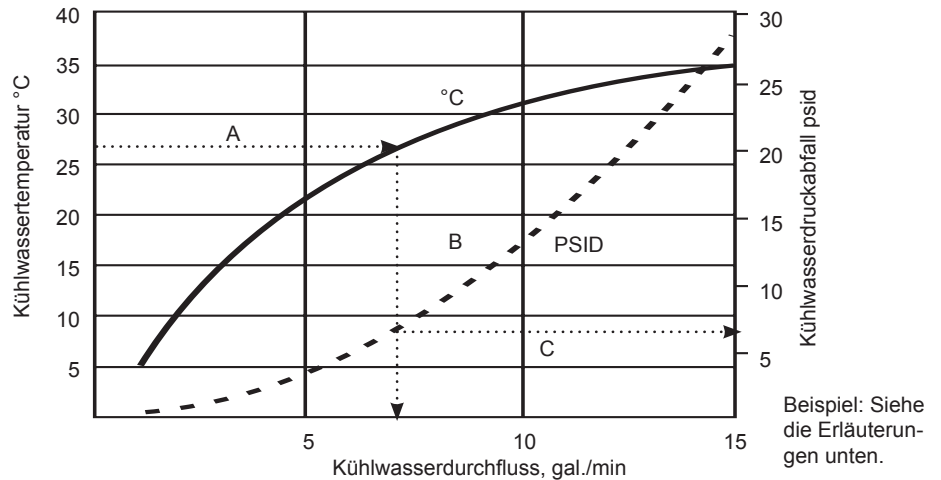
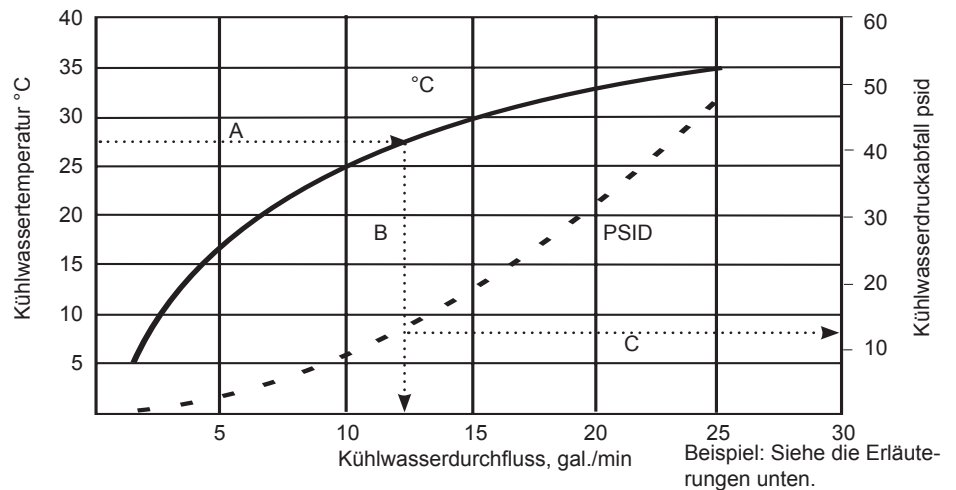
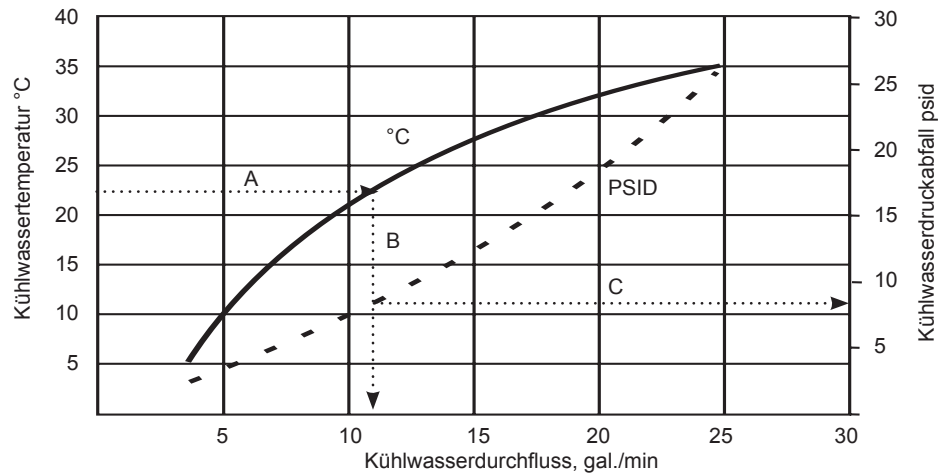
**ThermoFlex7500/10000****ThermoFlex15000/20000****ThermoFlex24000**

Beispiel:

Folgen Sie den ..... gepunkteten Pfeillinien.

Beginnen Sie mit einer bekannten Größe, z. B. mit der Kühlwassertemperatur.

A – Ermitteln Sie den Schnittpunkt mit der Temperaturkurve.

B – Ermitteln Sie auf der horizontalen Achse den zugehörigen minimal erforderlichen Kühlwasserfluss.

C – Gehen Sie vom Schnittpunkt der Linie B mit der PSID-Kurve zur rechten vertikalen Achse, um den minimal erforderlichen Druckabfall in psid zu ermitteln.

## Fluid Filter Bag



The reservoir has a fluid bag filter designed to prevent the introduction of particulates into the system.

**Install the filter bag before starting the chiller. ▲**

Place your fingers below the front of the housing and push up on the housing to remove it.

Fluid Bag Filter



Install the bag.

Replace the housing. Slide its back edge under the lip of the chiller's top panel and then press down until the housing snaps into place.

**Figure 3-6** Fluid Filter Bag

## Priming

If able, pre-fill the process fluid lines. The chiller is designed to shut down if not properly primed.

Ensure that there is enough fluid prepared to fill both the chiller and your application. If able, pre-fill the process fluid lines to reduce the setup time.

Fill the reservoir to the max fill line on the reservoir sight tube. To prevent the introduction of particulates into the system, fill the chiller with the reservoir bag filter in place.

Start the chiller using the power button  on the control panel.

As the pump fills your application add fluid to the reservoir to maintain the fluid level.

Repeat this process until the fluid level no longer drops in the reservoir.

If you need to pause priming use the power button to turn the chiller off.



**Not completely filling the chiller and process fluid lines could damage the chiller's pump. ▲**

## Initial Filling

Ensure the reservoir drain plug on the back of the chiller is in place, or the Riton fitting is closed, and that all plumbing connections are secure.



Before using any fluid refer to the manufacturer's MSDS for handling precautions. ▲

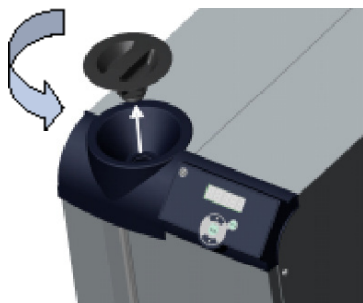

Locate and remove the reservoir cap by unscrewing it counterclockwise.

To prevent the introduction of particulates into the system, fill the chiller with the reservoir bag filter in place.

**Figure 3-7** Reservoir Cap

The reservoir has a sight tube and ball for easy fluid level monitoring. *Slowly* fill the reservoir with clean process fluid through the funnel only, failure to comply may result in internal spillage.

**Note** Filling the reservoir above **MAX LEVEL** fill line will result in an over flow error (**O FLO**) causing the chiller to shut down. ▲

Since the reservoir capacity may be small compared to your application and air may need to be purged from the lines, have extra cooling fluid on hand to keep the system topped off when external circulation is started.

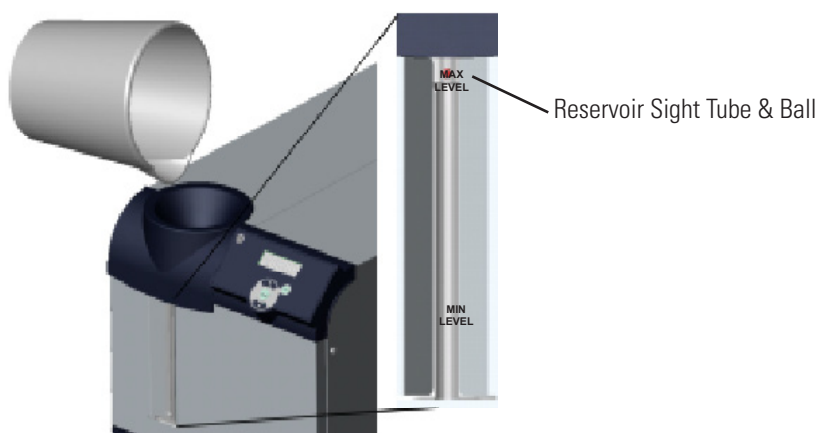

**Figure 3-8** Reservoir Sight Tube & Ball



Before replacing the reservoir cap ensure the reservoir sight tube ball stopper is securely in place, see next page. ▲

Replace the reservoir cap by screwing it clockwise. Cap should be hand tight.

## Fluid Top Off

Remove the reservoir cap by unscrewing it counterclockwise.

To prevent the introduction of particulates into the system, fill the chiller with the reservoir bag filter in place.

The reservoir has a sight tube and ball for easy fluid level monitoring. *Slowly* fill the reservoir with clean process fluid through the funnel only, failure to comply may result in internal spillage.

**Note** Filling the reservoir above MAX LEVEL fill line will result in an over flow error (**O FLO**) causing the chiller to shut down. Also, fluids expand when heated. ▲

**Note** Adding fluid that has a temperature differential with the fluid already in the reservoir will temporarily affect the chiller's stability performance. ▲



**Before replacing the reservoir cap ensure the reservoir sight tube ball stopper is securely in place. ▲**

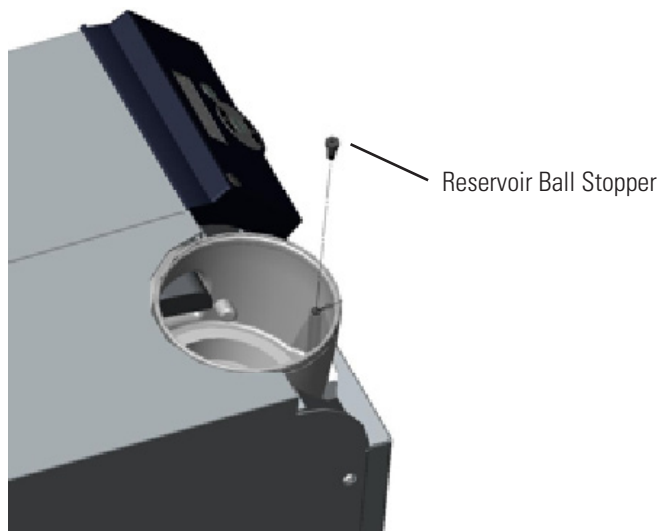
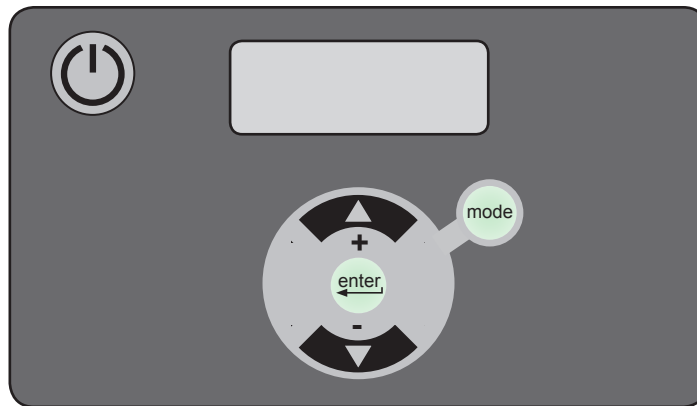

**Figure 3-9** Reservoir Ball Stopper

## Section 4 Operation

### Basic Controller

The controller controls temperature using a Proportional-Integral-Derivative (PID) algorithm. It is designed with an easy to use operator interface.



**Figure 4-1** Basic Controller



This key is used to start and stop the chiller.



This key is used to navigate through the controller displays, to make changes and to save changes once they are made. It is also used to clear error codes.



This key is also used to navigate through controller displays.



The up arrow key is used to navigate through the controller displays and to increase adjustable values.



The down arrow key is used to navigate through the controller displays and to decrease adjustable values.





## Setup

**Note** For first time use, please refer to the quick start instructions included with your chiller or the copy in this manual. The manual's version follows the Table of Contents. ▲

Before starting the chiller, double check all electrical and plumbing connections. Have extra recirculating fluid on hand. If the chiller will not start refer to Section 7 Troubleshooting.

If the chiller is equipped with a deionization filter cartridge refer to Section 5 for installation.

## Start Up

- Place the optional GFCI breaker located on the rear to the up position.
- For ThermoFlex900 through 10000s, place the circuit protector located on the rear to the on (I) position. The display will indicate a series of upward scrolling bars (☐ ☐).
- For ThermoFlex15000 and 24000s, the display will indicate a series of upward scrolling bars (☐ ☐) as soon as power is supplied.
- The bars will scroll upward indicating the controller is initializing. The initialization takes approximately 15 seconds.
- When the bars disappear the controller display will go blank.
- Press the  key on the controller. The controller will show the process fluid temperature. The pump and refrigeration system will also start. **Note** You can press the  key anytime after placing the circuit protector to the on position. ▲



**If the auto restart is enabled and the chiller shuts down as a result of a power failure, when power is restored the chiller will automatically restart. Auto restart is enabled using the Setup Loop, see Setup Loop in this Section. ▲**

**Note** After initial start up, check your plumbing for leaks. ▲

If desired, press the  key to display the pump's discharge pressure - **P1**. The display will alternate between **P1** and the pump's discharge pressure value.

If the chiller is equipped with an optional flow transducer, pressing  again will display the flow rate - **FLo**. The display will alternate between **FLo** and the flow rate value.

After displaying **P1** or **FLo** for 60 seconds, if the  key is not depressed the display will automatically revert to the process fluid temperature.

Press  again to display the process fluid temperature.

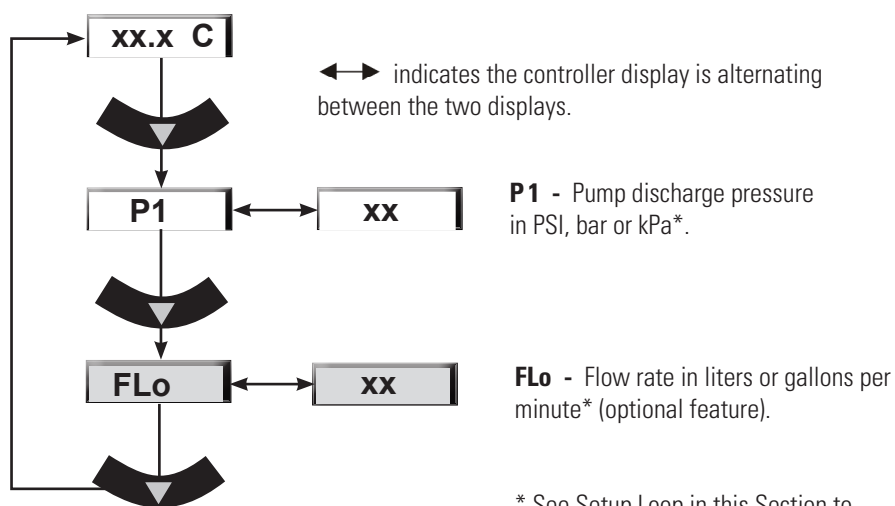

**Figure 4-2** Main Loop

\* See Setup Loop in this Section to change displayed scales.

## Controller Loops

The controller has the capability to display various loops which indicate operating conditions and parameters. The loops are selected and changed by pressing the appropriate keys.

When the controller is first powered up it goes through a short initialization (~15 seconds) and then displays the process fluid temperature. Use the key combination shown below to scroll through the loops.

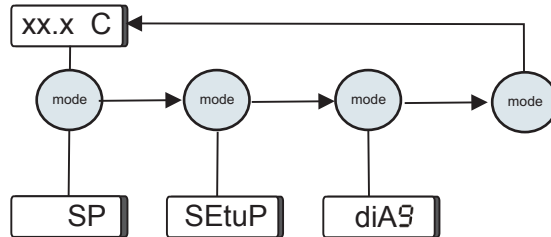

**Figure 4-3** Controller Loops (Chiller running)

**SP** is the Setpoint Loop and is used to display and change the setpoint. The setpoint is the desired process fluid temperature needed for your application. The Setpoint Loop is accessed by pressing the  key, see next page.

**SEtuP** is the Setup Loop. The Setup Loop allows you to display and/or alter different parameters of the controller. The Setup Loop is accessed from the **SP** display by pressing the  key.

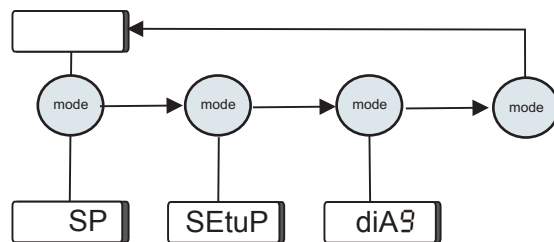

**diA9** is the Diagnostic Loop. The Diagnostic Loop allows you to display the operating times for various components. The Diagnostic Loop is accessed from the **Setup** display by pressing the  key, see Section 6 for more details.

**Note** The loops can be accessed and changed without the chiller running as long as the circuit protector (ThermoFlex900-10000s) is in the on (I) position. ▲





**Figure 4-4** Controller Loops (Chiller not running)

## Setpoint Loop (SP)

- Ensure the controller is either a blank screen or displaying the process fluid temperature.
- Press the  key and the controller display will alternate between **SP** and the setpoint value.
- If no change is required press the  key to return the controller to the previous display.
- If a setpoint change is required, use the  keys.

The setpoint range is +5°C to +40°C (41°F to 104°F).

**Note** If the  are not used within one minute the controller will time out and return to the previous display, any changes will not be saved. ▲

- Once the desired value is displayed press the  key to confirm the change.
- The controller will return to the process fluid temperature display or a blank screen.

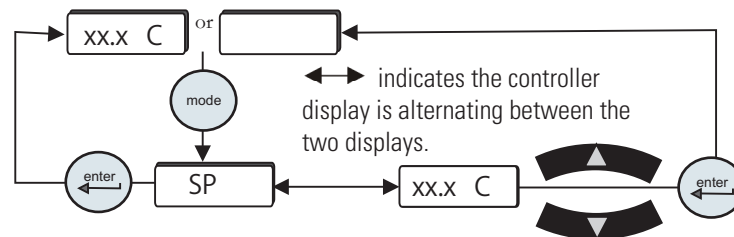

**Figure 4-5** Setpoint Loop

## Setup Loop (SEtUP)



Use the Setup Loop to adjust/verify the following controller settings.



- Scales: temperature in °C or °F, flow in liters per minute or gallons per minute (only chillers with an optional flow transducer), and pressure in PSI, bar or kPa
- High and low temperature alarm limits
- High and low pump discharge pressure alarm limits and time delays
- Chiller reaction to a temperature, pressure or flow (optional) alarm limit (continue to run or shut down)
- Audible alarm enabled/disabled
- View/change the fan speed (ThermoFlex2500 air-cooled only)
- Auto restart feature enabled/disabled
- Preventive care cleaning frequency reminder for air and fluid filters

### Optional Features:



- Global voltage
- Analog I/O
- Auto refill alarm
- DI filter cartridge preventive maintenance interval
- High/low flow alarm limits
- Serial communications
- Anti drainback valve position
- **Save or not save *all* changes**

To enter the Setup Loop ensure the controller display is either a blank screen (chiller off) or displaying the process fluid temperature. Press the  key and the display will indicate **SP**, press it again to display **SEtuP**.

Press the  key to continue, or press  twice to return to the process fluid temperature or blank display.

Use  to sequence down through the loop. Use  to sequence back through the loop up to the **Hi t** display, see next page.

To change any parameter:

- Press the  key.
- Use the  keys to change a displayed value.
- Press  key to confirm the change and bring up the next display.

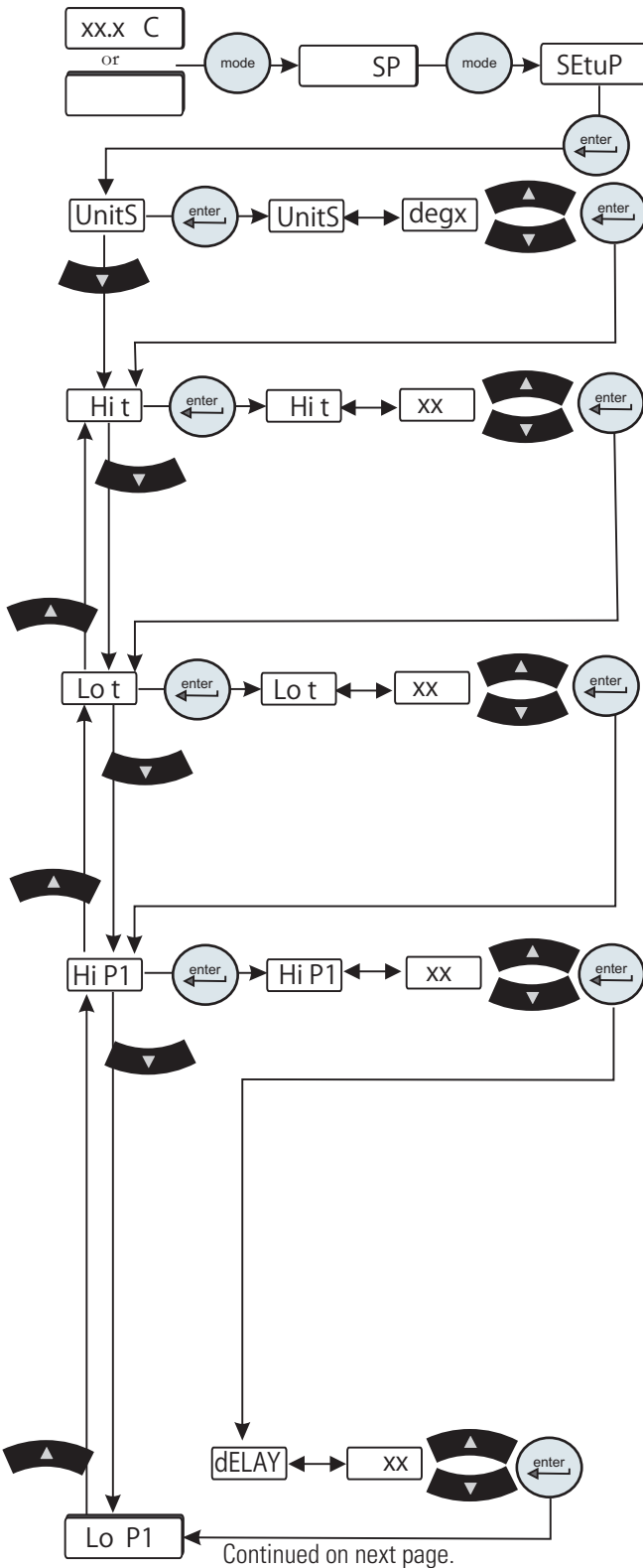

• **UnitS** are the temperature, fluid flow (only chillers with an optional flow transducer) and pressure display scales.  
**Scales:** °C or °F                      **Defaults:** °C  
 GPM or LPM                              GPM  
 PSI, Bar or kPa                          PSI

• **Hi t** is the fluid's High Temperature alarm limit.  
**Range:** +3°C to +42°C              **Default:** +42°C  
 Exceeding this limit flashes **Hi t** and, if enabled, sounds the alarm. The chiller reaction depends on the alarm configuration (see **ALr** on next page).

• **Lo t** is the fluid's Low Temperature alarm limit.  
**Range:** +3°C to +42°C              **Default:** +3°C  
 Falling below this limit flashes **Lo t** and, if enabled, sounds the alarm. The chiller reaction depends on the alarm configuration (see **ALr** on next page).

• **Hi P1** is the pump's High Pressure discharge alarm limit.  
 T1 T0 Pump **Range:** 3 to 100 PSI    **Default:** 100 PSI  
 T5 Pump **Range:** 2 to 105 PSI    **Default:** 105 PSI  
 P1 P2 Pump **Range:** 3 to 100 PSI    **Default:** 100 PSI  
 P3 Pump 60Hz **Range:** 3 to 46 PSI    **Default:** 46 PSI  
 P3 Pump 50Hz **Range:** 3 to 32 PSI    **Default:** 32 PSI  
 P4 Pump 60Hz **Range:** 3 to 85 PSI    **Default:** 85 PSI  
 P4 Pump 50Hz **Range:** 3 to 60 PSI    **Default:** 60 PSI  
 P5 Pump 60Hz **Range:** 3 to 87 PSI    **Default:** 87 PSI  
 P5 Pump 50Hz **Range:** 3 to 56 PSI    **Default:** 56 PSI

Exceeding this limit flashes **Hi P1** and, if enabled, sounds the alarm (see **Sound** on next page).

• **dELAY** is the length of time the pump can exceed the **Hi P1** alarm limit. **Note** This feature is only active if the chiller is configured to shut down with a pressure alarm. ▲  
**P1, P2, T0 and T1 Range:** 0 to 30 seconds  
**Default:** 0 seconds

**P3 - P5, T5 Range:** 0 to 60 seconds    **Default:** 0 seconds  
 Exceeding this limit flashes **Hi P1** and, if enabled, sounds the alarm. The chiller reaction depends on the alarm configuration (see **ALr** on next page).

Continued on next page.

**Figure 4-6** Setup Loop (All Chillers)



Continued from previous page

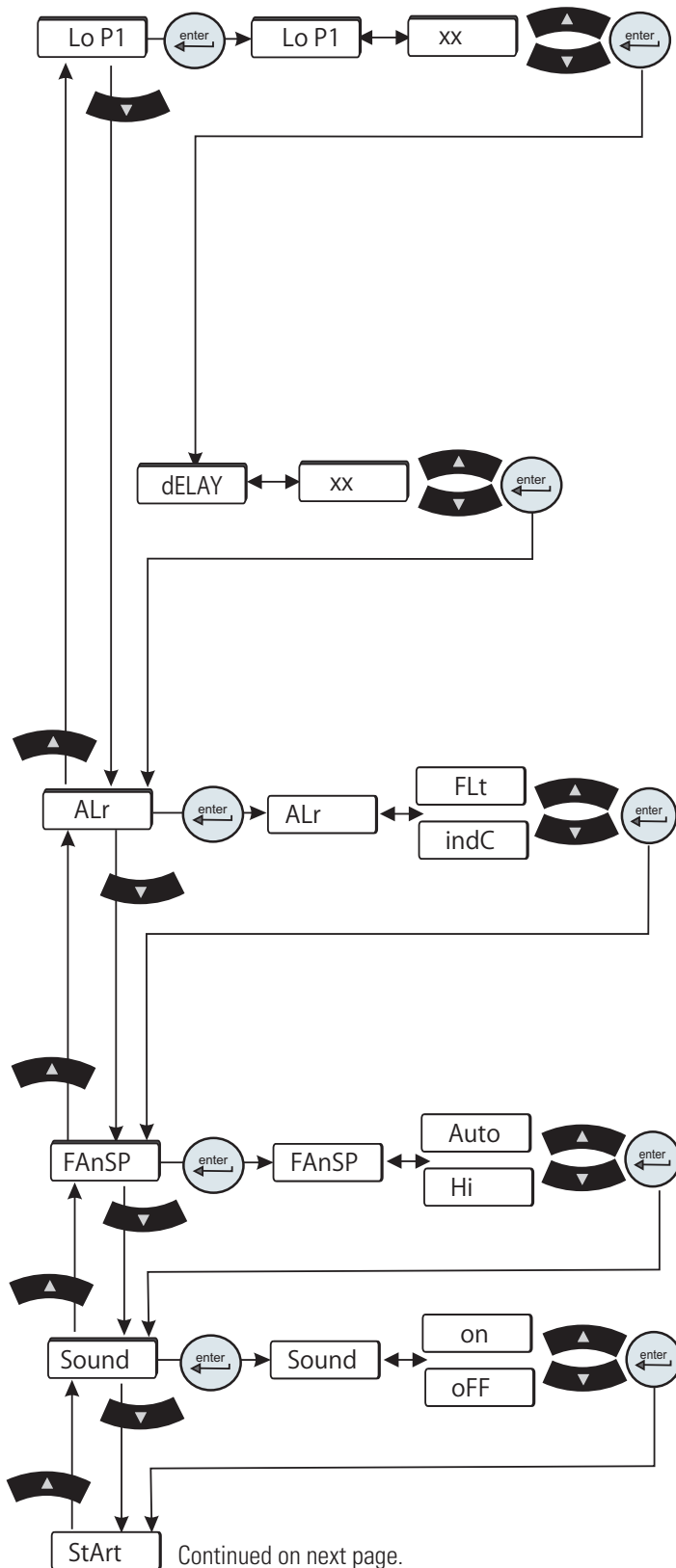

Continued on next page.

Figure 4-6 Setup Loop (All Chillers)

• **Lo P1** is the pump's Low Pressure discharge alarm limit.

- T0 T1 Pump **Range:** 3 to 100 PSI **Default:** 4 PSI
  - T5 Pump **Range:** 4 to 105 PSI **Default:** 4 PSI
  - P1 P2 Pump **Range:** 3 to 100 PSI **Default:** 4 PSI
  - P3 Pump 60Hz **Range:** 3 to 46 PSI **Default:** 4 PSI
  - P3 Pump 50Hz **Range:** 3 to 32 PSI **Default:** 4 PSI
  - P4 Pump 60Hz **Range:** 3 to 85 PSI **Default:** 4 PSI
  - P4 Pump 50Hz **Range:** 3 to 60 PSI **Default:** 4 PSI
  - P5 Pump 60Hz **Range:** 3 to 87 PSI **Default:** 4 PSI
  - P5 Pump 50Hz **Range:** 3 to 56 PSI **Default:** 4 PSI
- Going below this limit flashes **Lo P1** and, if enabled, sounds the alarm.

• **dELAY** is the length of time the pump can exceed the **Lo P1** alarm limit. **Note** This feature is only active if the chiller is configured to shut down with a pressure alarm. ▲

**Range:** 0 to 30 seconds **Default:** 10 seconds  
Exceeding this limit flashes **Lo P1** and, if enabled, sounds the alarm. The chiller reaction depends on the **ALr** alarm configuration set below.

• **ALr** is used to configure the chiller's reaction for exceeding an alarm limit (temperature, pressure and optional flow). The chiller will either shut down (**FLt**) or continue to run (**indC**). In each configuration, the controller will display the error code and sound the audible alarm, if enabled.

**Range:** FLt or indC **Default:** FLt

• **FAnSP** is used to control the fan speed (air-cooled 2500 only). **Auto** allows the fan to run under the conditions listed in Section 3. Selecting **Hi** allows the fan to run at high speed all the time. **Note Hi** is required for chillers to achieve a ThermoFlex2500 watt cooling capacity. ▲

**Range:** Auto or Hi **Default:** Auto

• **Sound** is used to enable/disable the audible alarm.  
**Range:** on or oFF **Default:** on

Continued from previous page

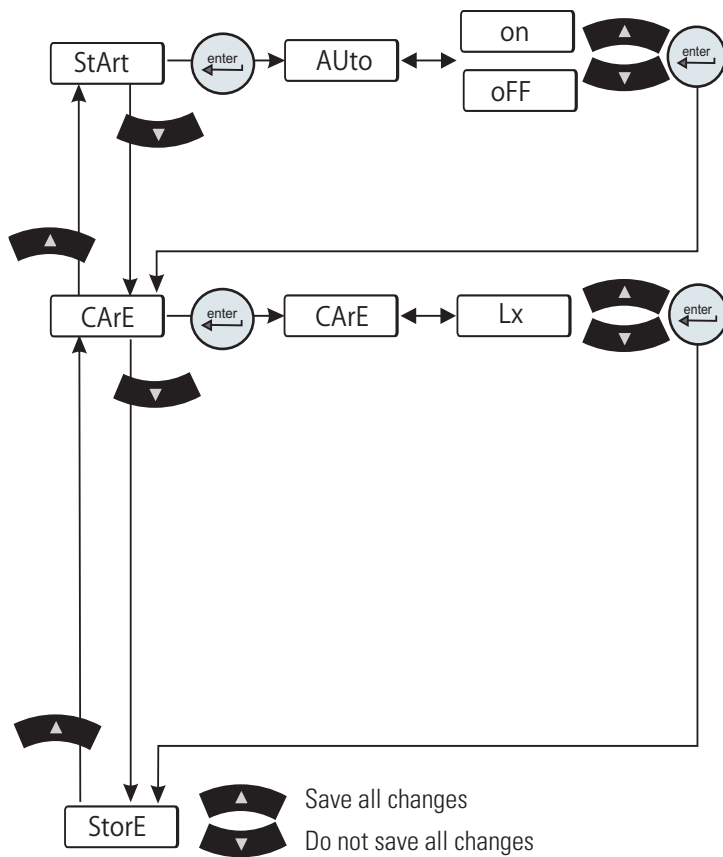

**Figure 4-6** Setup Loop (All Chillers)

• **StArt** is used to enable/disable the auto restart function. When enabled the chiller will automatically restart after a power failure or power interruption condition.

**Range:** on or oFF

**Default:** oFF

**NOTE** Consider any possible risks before enabling this mode of operation. ▲

• **CArE** is used to set the preventive care cleaning frequency reminder for the chiller's air and fluid filters, in hours. The time selected is based on your operating environment, see Section 6.

**Range:** off

**Default:** L1



L1 (1000 hours)

L2 (2000 hours)

L3 (3000 hours)

Off disables the reminder. Exceeding this limit flashes **FLtrS**, see Section 6.

**Note** If your chiller is equipped with any of the **Optional Features** refer to the next page. ▲

When the display indicates **StorE** press  to save *all* changes or press  to not save *all* changes. The display will return either the process fluid temperature or, if the chiller was off when you entered the loop, a blank screen.

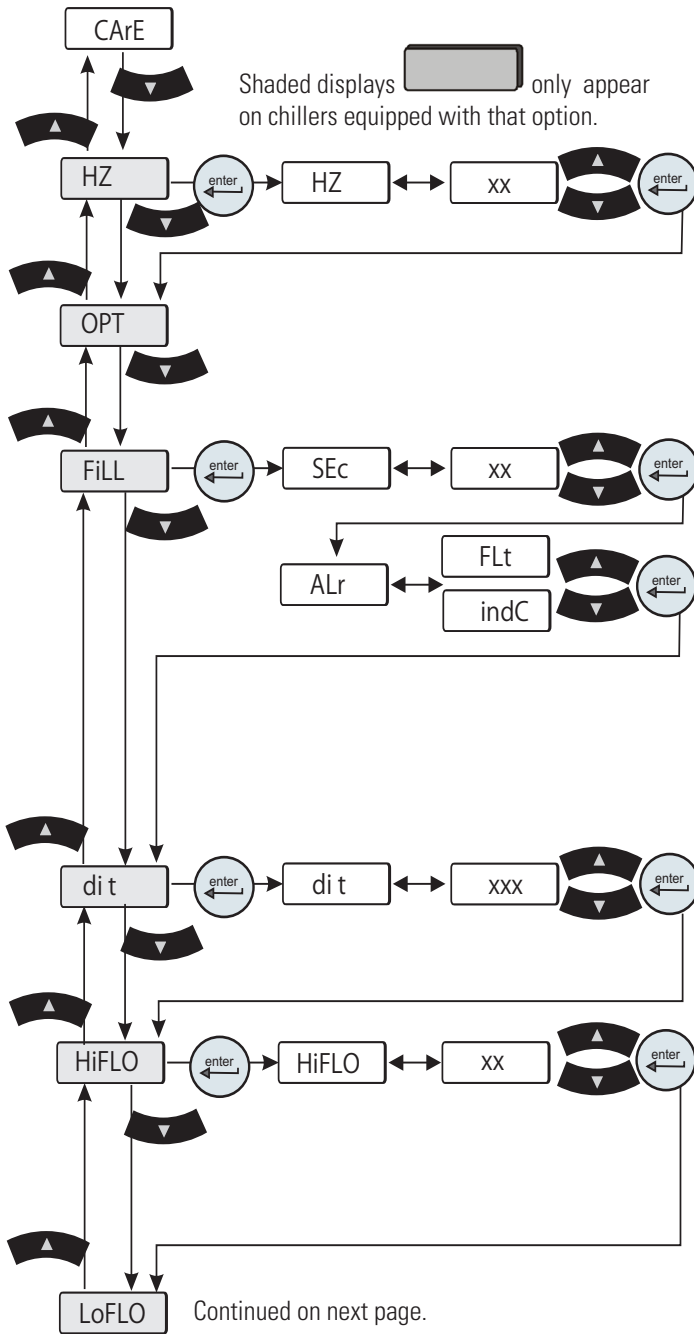

• **HZ** is used to identify the incoming frequency for chiller's with P3 - P5 pumps *and* the capability to run on either 50 Hz or 60 Hz. The selected frequency automatically adjusts the firmware's *fixed* high pressure default setting.  
**Range:** 50 Hz or 60 Hz      **Default:** 60 Hz

• **OPt** is used to configure the analog in/out mode of operation. See Appendix C.

• **FiLL** is used to set the time limit the auto refill has for filling the reservoir to the normal operating level.

**Range:** 0 to 900 seconds

**Default:** 45 seconds ThermoFlex900 - 5000

80 seconds ThermoFlex7500 - 24000

Exceeding the time limit flashes **REFiL** and the auto refill will shut off. The chiller's reaction depends on the alarm **ALr** setting, **FLt** is shut down, **indC** is continue to run.

**Note** Setting the time limit to 0 disables the auto refill option. ▲ See Section 5 for additional information.

• **di t** is used to set the preventive care cleaning frequency reminder for the chiller's DI filter cartridge.

**Range:** 0 to 9999 hours      **Default:** 448 hours

Exceeding the limit flashes **di**, see Section 6.

• **HiFLO** is used to set the high flow alarm limit.

T0 T1 **Range:** 0.0 to 10.5 GPM      **Default:** 0.0 GPM

T5 Pump **Range:** 0.0 to 15.0 GPM      **Default:** 0.0 GPM

P1 Pump **Range:** 0.0 to 10.5 GPM      **Default:** 0.0 GPM

P2 Pump **Range:** 0.0 to 10.5 GPM      **Default:** 0.0 GPM

P3 Pump **Range:** 0.0 to 30.0 GPM      **Default:** 0.0 GPM

P4 Pump **Range:** 0.0 to 30.0 GPM      **Default:** 0.0 GPM

P5 Pump **Range:** 0.0 to 30.0 GPM      **Default:** 0.0 GPM

Exceeding a high limit flashes **HiFLO** and, if enabled, sounds the alarm. The chiller's reaction depends on the alarm (**ALr**) setting.

**Note** This feature is not enabled until the value is changed to something other than 0.0. ▲

**Figure 4-7** Setup Loop (Optional Features)

Continued from previous page

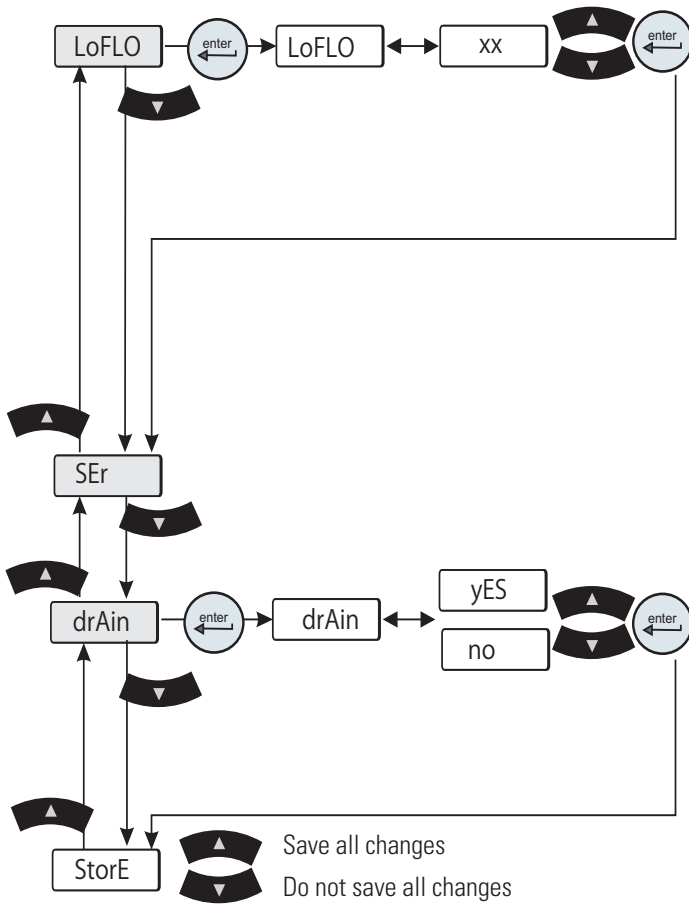

**Figure 4-7** Setup Loop (Optional Features)

• **LoFLO** is used to set the low flow alarm limit.

T0 Pump	<b>Range:</b> 0.0 to 10.5 GPM	<b>Default:</b> 0.0 GPM
T1 Pump	<b>Range:</b> 0.0 to 10.5 GPM	<b>Default:</b> 0.0 GPM
T5 Pump	<b>Range:</b> 0.0 to 15.0 GPM	<b>Default:</b> 0.0 GPM
P1 Pump	<b>Range:</b> 0.0 to 10.5 GPM	<b>Default:</b> 0.0 GPM
P2 Pump	<b>Range:</b> 0.0 to 10.5 GPM	<b>Default:</b> 0.0 GPM
P3 Pump	<b>Range:</b> 0.0 to 30.0 GPM	<b>Default:</b> 0.0 GPM
P4 Pump	<b>Range:</b> 0.0 to 30.0 GPM	<b>Default:</b> 0.0 GPM
P5 Pump	<b>Range:</b> 0.0 to 30.0 GPM	<b>Default:</b> 0.0 GPM

Going below the low limit flashes **LoFLO** and, if enabled, sounds the alarm. The chiller's reaction depends on the alarm (**ALr**) setting.

This feature is not enabled until the value is changed to something other than 0.0. If the feature is not enabled and the flow rate drops below the flow rate listed below the chiller will continue to run and the controller will flash between **FLo** and **LoFLo**.

P1, T0, T1 and T5 Pump	0.3 GPM
P2 Pump	1.0 GPM
P3, P4 and P5 Pump	4.0 GPM



• **SEr** is used to configure the serial communications mode of operation. See Appendix D.

**Note** Keypad operation is still available with serial communications enabled. ▲

• **drAin** is used to open and close the chiller's anti drainback valve for draining, see Section 5.

**Range:** yes or no                      **Default:** no

**Note** The chiller must be off to drain the valve. The valve automatically closes when you exit the **drAin** display. ▲

When the display indicates **StoreE** press  to save *all* changes or press  to not save *all* changes. The display will return either the process fluid temperature or, if the chiller was off when you entered the loop, a blank screen.

## Shut Down

Press the  key on the controller.

**Note** To protect the chiller's compressor, the chiller will enter a 5 to 20 second shut down cycle (colder process fluids take longer) before the refrigeration system and pump shut down. During this time the display will indicate . The bars will scroll downward indicating the controller is in the shut down cycle. ▲

Using any other means to shut the chiller down can reduce the life of the compressor.

For ThermoFlex900 - 10000 chillers, when the display goes blank it is safe to place the circuit protector located on the rear to the off ( **0** ) position.



**Always turn the chiller off and disconnect it from its supply voltage before moving.** ▲



**For ThermoFlex900 - 10000s, the circuit protector located on the rear is not intended to act as a disconnecting means.** ▲

## Section 5 Options/Accessories

### Auto Refill

The Auto Refill provides makeup fluid to replace any fluid lost to evaporation, etc. It requires a pressurized fluid source connection to the 1/4" Female Pipe Thread fitting on the rear of the chiller. (If Teflon® tape is used, ensure the tape does not cover the connection's starting-end thread.)

**Note** ThermoFlex7500 through 24000s with a P3 or P5 or ThermoFlex7500s and 10000s with a T5 pump have a 1/4" Male brass plug installed in the connection, remove the plug before connecting the makeup fluid. ▲



**Figure 5-1** Auto Refill Fitting

The auto refill fluid must also meet water quality standards or the valve may fail to operate as designed, see Section 3.

The auto refill valve input pressure must be < 80 PSI to ensure the valve functions properly.

The auto refill operates when all of the following conditions are met:

- Fluid is available
- The chiller is turned on
- The fluid reaches a low level condition.

The auto refill shuts off when:

- The fluid reaches the correct operating level.
- The delay timer exceeds user fill time entered in the Setup Loop, see Section 4. If **FLt** is selected in the Setup Loop the chiller also shuts down. (If **indC** is selected the chiller continues to run.) In either case the controller will display **rEFIL**.
- The chiller shuts down for any reason.

Setting the fill time to 0 disables auto refill. If a low level condition occurs the chiller will:

- If **Indc** is selected, continue to run and the controller displays **Add**.
- If **FLt** is selected, shut down and the controller displays **LLF**.



## Internal DI Cartridge

A partial flow DI filter cartridge is designed to maintain water resistivity between 1 and 3 MΩ-cm.

**Note** The DI option results in a 0.5 gpm reduction of available flow. ▲



**Do not use a Deionization (DI) filter cartridge with Inhibited EG or Inhibited PG. A DI filter will remove inhibitors from the solution rendering the fluid ineffective against corrosion protection. Also, inhibitors increase fluid conductivity. ▲**

The Puralite sensor on the back of the chiller turns red when the cartridge needs changing (< 1 MΩ-cm), see Section 6. **Note** The Puralite sensor that comes with the DI cartridge requires a separate power source. ▲

Remove the two thumbscrews securing the DI access panel. Remove the new cartridge from the shipping bag. The cartridge has a blue and a white connector. Lower the cartridge into the chiller with the blue connector facing downward. Press down on the cartridge lightly to engage and then rotate it ¼ turn clockwise (do not over rotate) or until you feel the filter click into place.

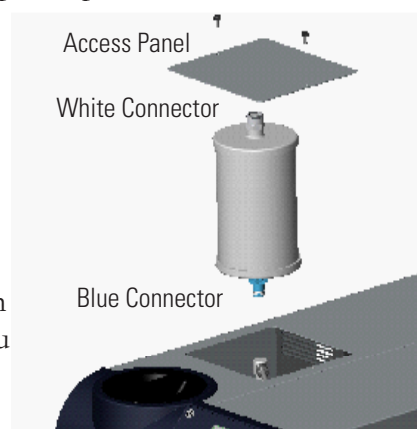
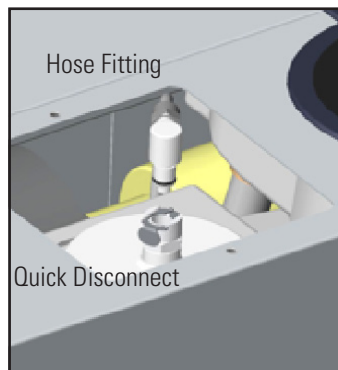

**Figure 5-2** Internal DI Cartridge

If there is a cartridge in place, first undo the hose fitting by pressing on the quick disconnect located on the top white connection.



**The DI Cartridge will overpressurize if it is removed from the chiller before removing the hose fitting. ▲**



**Figure 5-3** DI Fittings

Next rotate the cartridge ¼ turn counter-clockwise and then pull the cartridge straight up to remove it.

Push the hose fitting into the quick disconnect located on the white end of the cartridge.

Replace the access panel and thumbscrews.

**Note** The cartridge can be changed with the chiller running, however, since the cartridge runs in a parallel arrangement, disconnecting the cartridge adds 0.5 gpm to the main flow. The additional flow will cause an increase in system pressure which may cause a high fluid pressure fault. ▲

## P1 P2 T0 T1 Pump Pressure Relief Valve (Internal Configuration)

Use the pressure relief valve, located on the top left rear of the chiller, to set the desired system back pressure to your application. The valve is factory preset to  $80 \pm 5$  psi ( $5.5 \pm 0.4$  bar).

*If the chiller is not plumbed to an application, set the pressure by installing a loop of hose equipped with a shut-off valve between the supply and return fittings. Start the chiller and allow it to prime, then close the valve.*

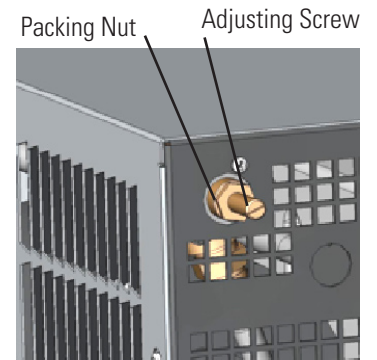

**Figure 5-4** Nut and Screw

Use the controller's  to display P1, it should display  $80 \pm 5$  psi.

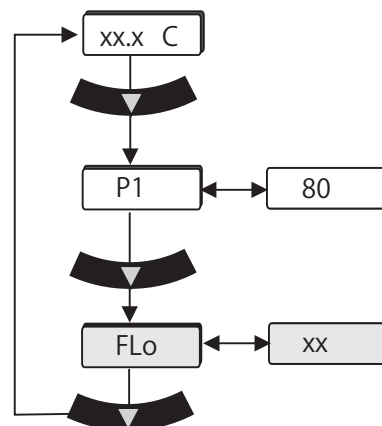

**Figure 5-5** Main Loop

Use a screwdriver to turn the adjusting screw (counterclockwise to reduce pressure) until the controller displays the desired setting. 

**Note** Due to internal back pressure, the minimum pressure setting for a deadheaded P2 pump is 32 psi (2.2 bar), and 8 psi (0.6 bar) for a P1 (these settings prohibit external flow from the chiller). ▲

*If the chiller is plumbed to an application, ensure the chiller is off. Then back out the adjusting screw counterclockwise to reduce pressure. Turn the chiller on. Ensure that there is back pressure in the system. Turn the adjusting screw until the controller displays the desired setting.*



**Do not exceed 100 psi (6.9 bar).** ▲

When complete, inspect the area around the  $\frac{5}{8}$ " packing nut for fluid leaks. If fluid is present, slightly tighten the nut and reinspect.

**Note** Should the chiller start to vibrate the valve setting may be the cause. Changing the pressure setting  $\pm 5$  psi (0.3 bar) will eliminate the vibration. ▲

# P1 P2 T0 T1 Pump Pressure Relief Valve (External Configuration)

Use the pressure relief valve to set the desired system back pressure (P1) to your application. The valve is factory preset to  $80 \pm 5$  psi ( $5.5 \pm 0.4$  bar).

The valve's inlet/outlet connections are  $\frac{1}{2}$ " FNPT.

*If the chiller is not plumbed to an application, set the pressure by installing a loop of hose equipped with a shut-off valve between the supply and return fittings. Start the chiller and allow it to prime, then close the valve.*

Adjusting Screw  
Packing Nut

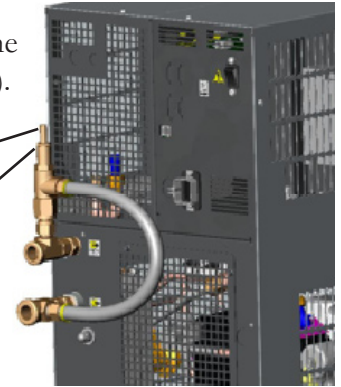

**Figure 5-6** Nut and Screw

Use the controller's  to display P1, it should display  $80 \pm 5$  psi.

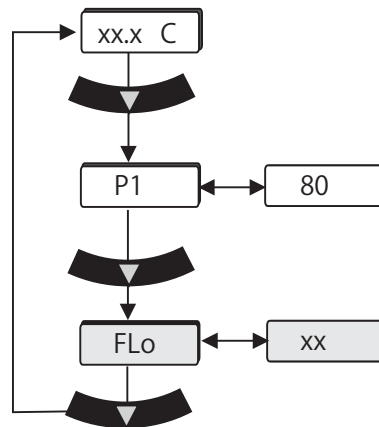

**Figure 5-7** Main Loop

Use a screwdriver to turn the adjusting screw (counterclockwise to reduce pressure) until the controller displays the desired setting.



**Note** Due to internal back pressure, the minimum pressure setting for a deadheaded P2 pump is 40 psi (2.8 bar), and 22 psi (1.5 bar) for a P1 (these settings prohibit external flow from the chiller). ▲

*If the chiller is plumbed to an application, ensure the chiller is off. Then back out the adjusting screw counterclockwise to reduce pressure. Turn the chiller on. Ensure that there is back pressure in the system. Turn the adjusting screw until the controller displays the desired setting.*



**Do not exceed 100 psi (6.9 bar). ▲**

When complete, inspect the area around the  $\frac{5}{8}$ " packing nut for fluid leaks. If fluid is present, slightly tighten the nut and reinspect.

## Flow Control with Flow Readout

Flow control for P1, P2, T0 and T1 pumps on ThermoFlex900 - 5000s is achieved using a 3-way valve plumbed between the standard process outlet and the process inlet on the rear of the chiller. Use the auxiliary process outlet at the top left of the rear of the chiller as a connection point. The connections are 1/2" FNPT. See Figure 5-8.

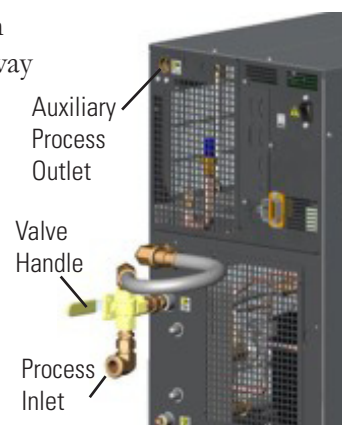

**Figure 5-8** Flow Control

ThermoFlex3500 and 5000s with P3 and P4 pumps use a 2-way valve located on the rear of the chiller. The connections are 3/4" FNPT. See Figure 5-9.

ThermoFlex7500 and 24000s with P2 - P5 and T5 pumps (see next page) use a valve located on the rear of the chiller. The connections are 1/2" FNPT for P2, 1" FNPT for P3 and P5. See Figure 5-9.

Press the controller's down arrow  twice to display the controller's **FLO** display, see previous page. Turn the valve handle until the desired rate is displayed.



**Figure 5-9** Flow Control Handle (Typical)

**Note** The valve is sensitive to slight adjustments. ▲

## P1 P2 T0 T1 Pump Pressure Relief with Flow Readout

The Pressure Relief with Flow Readout works just like the Pressure Relief Valve discussed on the previous page. It allows you to control the pressure going to your application.

This valve is plumbed between the standard process outlet and the process inlet on the rear of the chiller. Use the auxiliary process outlet at the top left of the rear of the chiller as a connection point, allowing you to also monitor the flow rate to your application using the controller's **FLO** display, see previous page.

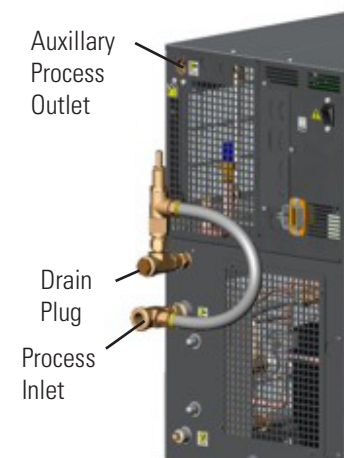
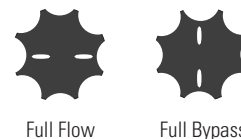

**Figure 5-10** Pressure Relief

The valve's outlet connection is 1/2" FNPT. See Figure 5-10.

## T5 Pump Flow Control

T5 Flow Control valve is designed with slots to quickly identify its position. When the slots are in the horizontal position (in line with the discharge line) the application is receiving full flow. With the slots are vertical the valve is in full bypass.



## Anti-Drainback

Chillers installed below the end-user application may allow system fluid to drain back into the chiller and cause spillage. The anti-drainback valve is designed to prevent any such spillage.

The valve opens just before the pump is turned on and it closes just after the pump shuts off.

This option is required if your chiller is more than 24 feet below your application, or if there is a possibility of drain back due to the opening of the process lines for either application swaps or chiller servicing.

## Semiconductor Equipment and Materials International (SEMI) Chillers

(ThermoFlex900-10000 only)

### Compliance

SEMI chillers are compliant with:

**SEMI S2-0703 Product Safety Assessment**

**SEMI S8-0705 Ergonomic Assessment**

**SEMI S14-0704 Fire Risk Assessment**

**SEMI F47-0706**

### Emergency Off (EMO)

A guarded red mushroom shaped push-button switch with twist-to-reset is provided on the chiller's front to turn it off in case of an emergency. The button head is engraved with "EMO" in large white filled letters.

**Note** The EMO is controlled by a safety circuit and is not influenced by the chiller's firmware/software. ▲

Activation of the EMO button will remove power from the main contactor coil stopping operation of the chiller. The controller will display **Er 48**.

Resetting the EMO button will not restart the chiller. After all hazards have been removed reset the chiller by pushing the enter key on the controller. In the local mode, the chiller will restart by pressing the START STOP button again. In the serial communications mode, send the appropriate start command. In the analog I/O mode, the chiller starts when the error is cleared.

### Chiller Circuit Breaker Interrupt Rating

The main power circuit breaker located on the rear of the chiller has an Interrupting Capacity (AIC) of 10,000 amps.

### Lockout/Tagout (LOTO)

Before performing Chiller maintenance, the energy sources associated with the Chiller system must be lockedout and tagged out (LOTO). Hazard control features added to the system (e.g., safety interlocks, EMO) are not a substitute for turning off and locking out electrical or fluid energy.

For chillers rated 20 Amps or less, electrical LOTO is accomplished by removing the power cord on the rear of the chiller then closing and locking the power receptacle locking device. For other chillers, electrical LOTO is the responsibility of the user and can be provided by:

- Using the main disconnect (knife switch at system control cabinet).
- Disconnecting main power at the facility power source prior to the system controller cabinet.
- In addition, follow all OSHA and local facility LOTO directives.

### Drip Pan and Drain

The chiller is equipped with a secondary containment (drip pan) in case there is a leak. The drip pan drain is located on the rear of the chiller. Install the supplied nylon 1/4 turn quick disconnect (QD) fitting into the drain fitting. The QD is barbed for a 1/2" ID hose.

Since the drip pan will not hold more than 110% of the reservoir volume, connect the drain to guide the fluid to an appropriate spillage location.

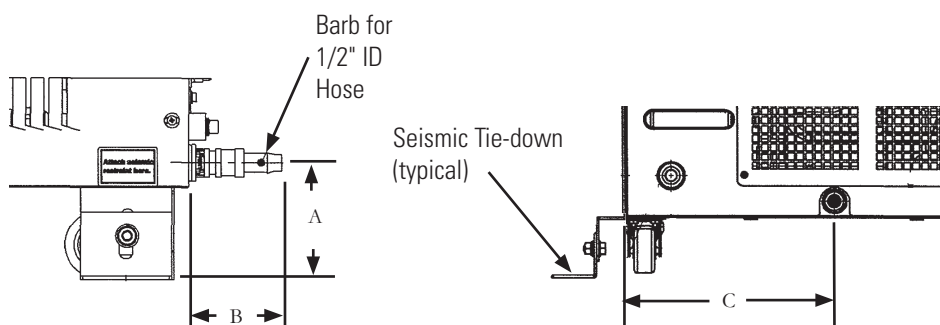

1/4 Turn Quick Disconnect Drip Pan Drain Fitting

**Figure 5-11** Drip Pan Drain

	900/1400		2500		3500/5000		7500/10000	
A	3 1/2"	8.8 cm	4"	10.1 cm	3 3/8"	11.3 cm	4 1/4"	10.8 cm
B	2 3/4"	7.0 cm	2 11/16"	6.8 cm	2 3/4"	7.1 cm	2 5/8"	6.6 cm
C	6 15/16"	17.7 cm	6 9/16"	16.7 cm	9 9/16"	24.3 cm	7 11/16"	19.5 cm

### Seismic Tie-Downs

Install the seismic tie-downs to the chiller as shown below. Then secure the chiller to the floor with user-supplied hardware.

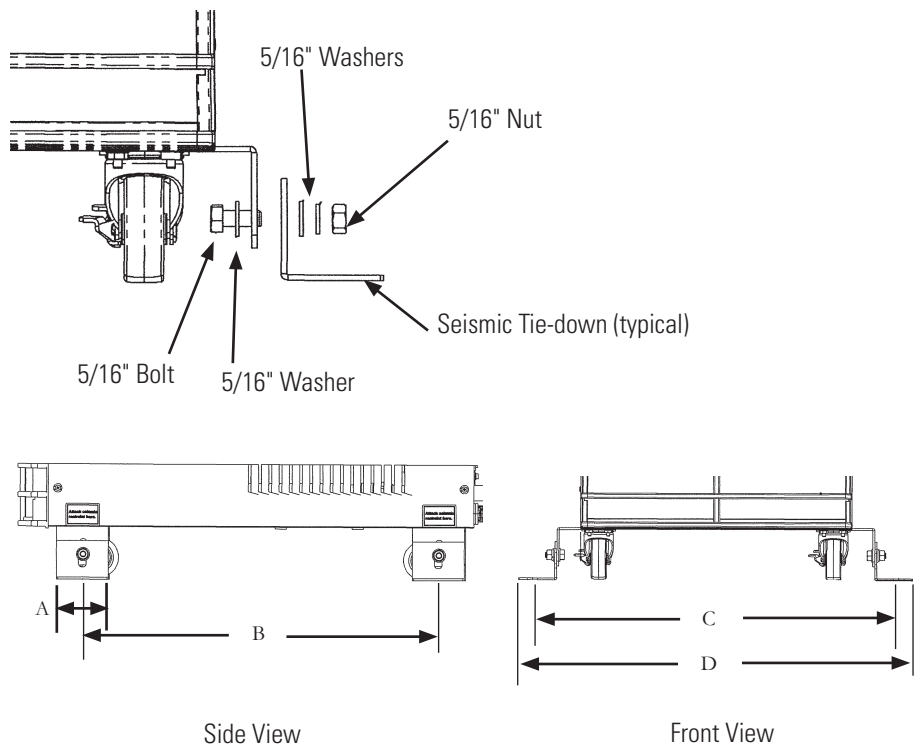

**Figure 5-12** Seismic Tie-Downs

	900/1400		2500		3500/5000		7500/10000	
A	2 11/16"	6.8 cm	2 11/16"	6.8 cm	2 11/16"	6.8 cm	2"	5.1 cm
B*	18 1/2"	47.0 cm	20 1/16"	51.0 cm	24 1/2"	62.2 cm	17"	43.1 cm
C*	19 11/16"	50.0 cm	22 3/4"	57.8 cm	24 3/4"	62.9 cm	27 7/16"	69.6
D	21 3/16"	53.8 cm	24 1/4"	61.5 cm	26 1/4"	66.7 cm	28 15/16"	73.4

\* Distance between Ø.53 Seismic mounting holes



## Center of Gravity

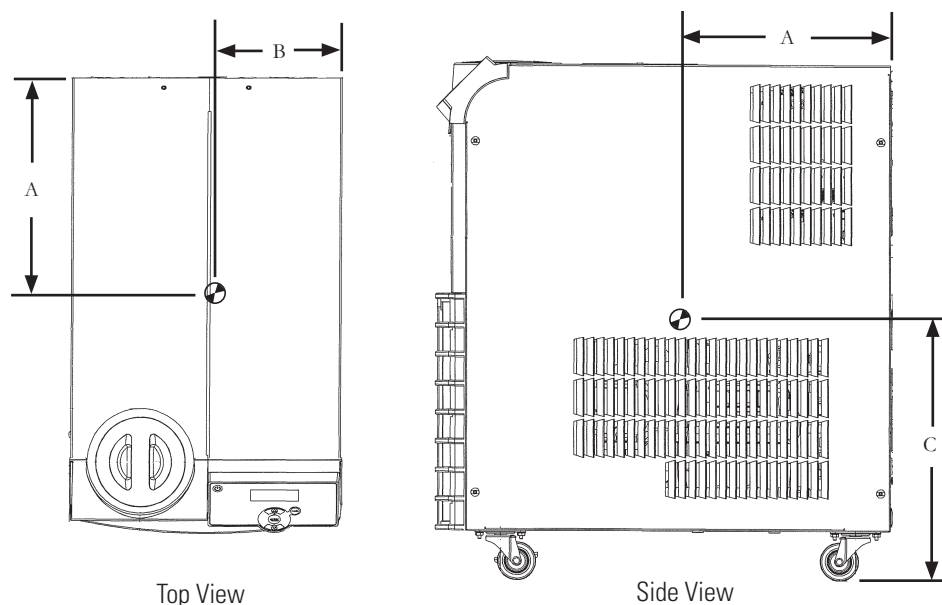

**Figure 5-13** Center of Gravity

Center of Gravity  $\pm \frac{1}{2}$ ", air-cooled chiller, no fluid in tank

	900/1400 P2 Pump		2500 P2 Pump		3500/5000 P2 Pump		7500/10000 P3 Pump	
A	10 <sup>3</sup> / <sub>4</sub> "	27.3 cm	12"	30.5 cm	13 <sup>3</sup> / <sub>8</sub> "	34.0 cm	14 <sup>7</sup> / <sub>8</sub> "	37.8 cm
B	6 <sup>3</sup> / <sub>4</sub> "	17.2 cm	8 <sup>3</sup> / <sub>8</sub> "	21.3 cm	9"	22.9 cm	13 <sup>1</sup> / <sub>8</sub> "	33.3 cm
C	13 <sup>1</sup> / <sub>2</sub> "	34.3 cm	13 <sup>1</sup> / <sub>2</sub> "	34.3 cm	17"	43.2 cm	26"	66.0 cm

	20000 P3 Pump		24000 P3 Pump		3500/5000 P4 Pump Global Voltage	
A	13 <sup>3</sup> / <sub>4</sub> "	34.9 cm	12"	30.5 cm	12 <sup>3</sup> / <sub>8</sub> "	31.4 cm
B	21 <sup>5</sup> / <sub>8</sub> "	54.9 cm	8 <sup>3</sup> / <sub>8</sub> "	21.3 cm	9 <sup>3</sup> / <sub>4</sub> "	24.8 cm
C	21 <sup>1</sup> / <sub>4</sub> "	54.0 cm	13 <sup>1</sup> / <sub>2</sub> "	34.3 cm	19 <sup>1</sup> / <sub>2</sub> "	49.5 cm

Center of Gravity  $\pm \frac{1}{2}$ ", water-cooled chiller, no fluid in tank

	3500/5000 P2 Pump		20000 P3 Pump		24000 P3 Pump	
A	13"	33.0 cm	17"	43.2 cm	12"	30.5 cm
B	9 <sup>1</sup> / <sub>2</sub> "	24.1 cm	22"	55.9 cm	23"	58.4 cm
C	16"	40.6 cm	20 <sup>1</sup> / <sub>2</sub> "	52.1 cm	21"	53.3 cm

Weight Distribution  $\pm 2$  lbs, air-cooled chillers

	900/1400 P2		2500 P2		3500/5000 P2		7500/10000 P3	
Left Front	27.1 lbs	12.3 kg	40.7 lbs	18.5 kg	62.0 lbs	28.1 kg	97.8 lbs	44.4 kg
Left Rear	29.8 lbs	13.5 kg	42.0 lbs	19.1 kg	63.7 lbs	28.9 kg	99.9 lbs	45.3 kg
Right Front	32.9 lbs	14.9 kg	45.7 lbs	20.7 kg	68.2 lbs	30.9 kg	89.2 lbs	40.5 kg
Right Rear	36.2 lbs	16.4 kg	47.1 lbs	21.4 kg	70.0 lbs	31.8 kg	91.1 lbs	41.3 kg

## **Other Accessories**

Installation kit - includes replacement air and fluid filters

Maintenance kit - includes a set of hoses, adaptor fittings and Teflon<sup>®</sup> tape

Fluids

Fluid treatment kit

Please contact Thermo Fisher Scientific's Sales, Service and Customer Support to assist you with questions that you may have regarding accessories for your ThermoFlex, see inside front cover for contact information.

## Section 6 Preventive Maintenance

### Preventive Maintenance Timer (CARE)

Only Thermo Fisher should provide any required replacement parts.

The ThermoFlex chiller has an integrated preventive maintenance timer that will alert you when it is time to perform preventive maintenance. This unique feature will remind you to change your air and fluid filters.

Based on the environment in which your chiller is located, you can choose from four levels of preventive maintenance off, L1, L2, and L3:

- off – Disables the alert
- L1 – 1,000 hours - default setting
  - Heavy manufacturing environment
  - Airborne particulate created during manufacturing process
- L2 – 2,000 hours
  - Typical production environment
- L3 – 3,000 hours
  - Clean environment – filtered air
  - Typically laboratory or research environment

Change/set the level using the Setup Loop, see Section 4. When the chiller exceeds the chosen limit, the controller will flash **Chn9** **FLt5** and, if enabled, an audible alarm will sound.

To clear this message press . This will automatically restart the preventive maintenance timer for your filters. Each time the chiller exceeds the chosen time, the controller will remind you that it is time to change your filters.

If you change your filters before the preventive timer trips, you can clear the timer by using the Diagnostic Loop explained in this Section.

**Note** For air-cooled chillers, both the air and fluid filters in the ThermoFlex can be changed while the chiller is running. For water-cooled chillers, only the fluid filter can be changed while the chiller is running. ▲

## Fluid Filter Bag

The reservoir has a fluid bag filter designed to prevent the introduction of particulates into the system.

**Note** The fluid bag filter can be removed with the chiller operating. ▲



**Before using any fluid or performing maintenance where contact with the fluid is likely refer to the manufacturer's MSDS for handling precautions.** ▲

Fluid Bag Filter



When it is time to replace the bag, gently pull up on the plastic funnel housing to remove it and simply pull the bag out of the chiller. Replacement bags are available from Thermo Fisher Scientific.

**Figure 6-1** Fluid Filter Bag



**Before replacing the reservoir housing ensure the reservoir sight tube ball stopper is securely in place, see next page.** ▲

## Fluid Diffuser

On ThermoFlex900-5000s, when you remove the bag you will notice a wire mesh fluid diffuser inside the reservoir supply line, see Figure 6-2. The diffuser is used to help streamline the flow into the reservoir. After several bag replacements turn the chiller off and remove the diffuser to inspect it for debris/damage.



**The fluid velocity into the reservoir will rapidly increase with the diffuser removed and cause splashing. Turn the chiller off before removing the diffuser. This is especially critical when using ethylene or propylene glycol.** ▲

**Note** To prevent particulates from entering the reservoir, ensure the fluid bag filter is in place before removing the diffuser. ▲



**Do not operate the chiller unless the diffuser is installed.** ▲

## Reservoir Cleaning

The user is responsible for maintaining reservoir fluid quality. Check the fluid on a regular interval. Start with frequent checks until a regular interval (based on your application) is established.

If cleaning is necessary, flush the reservoir with a fluid compatible with the process fluid and the chiller's wetted parts, see Section 8.



**Before using any fluid or performing maintenance where contact with the fluid is likely refer to the manufacturer's MSDS for handling precautions. ▲**

### Reservoir Sight Tube

Clean the sight tube by gently pulling up on the plastic funnel housing to remove it (see illustration on previous page) and then gently pulling out the black sight ball stopper from the tube. Use a long soft-bristle ¼" brush. Use caution not to scratch the glass.



**Before replacing the reservoir housing ensure the reservoir sight tube ball stopper is securely in place. ▲**

For easier replacement, wet the stopper first and then use a twisting motion to install it in the sight tube.

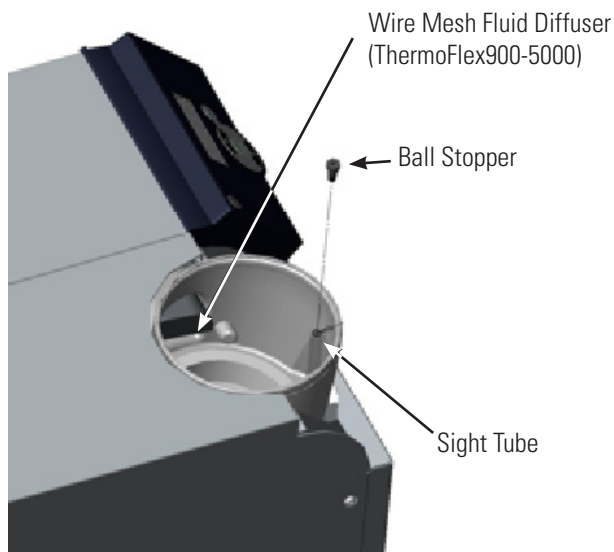

**Figure 6-2** Reservoir Cleaning and Diffuser

## Fluid Maintenance

An effective recommended maintenance plan would include changing the fluid every six months to optimize chiller reliability, see Section 3 for additional information.

## Condenser Filter



Failure to clean/replace the condenser filter will cause a loss of cooling capacity and lead to premature cooling system failure . ▲

### ThermoFlex900 - 5000

Clean the filter through the grill using a vacuum with a soft-bristle brush.

When it is time for a more thorough cleaning, remove the one-piece grill assembly by first pulling the bottom of the assembly away from the chiller and then pulling it away from the top.



The condenser framing and fins located behind the grill assembly are very sharp. Use caution when removing the assembly. ▲

**Note** ThermoFlex900 - 5000 water-cooled chillers have an embedded screw(s) located at the top (and bottom) of the grill. Loosen the screw(s) to remove the grill. ▲



Water-cooled chillers also have a fan with sharp blades, ensure the chiller is off before removing the assembly. ▲

Shake off as much of the excess water as possible before reinstalling. Press the grill back into place.

For water-cooled chillers, tighten the screw(s) at the top (and bottom) of the grill.

Replacement grill assemblies are available from Thermo Fisher.

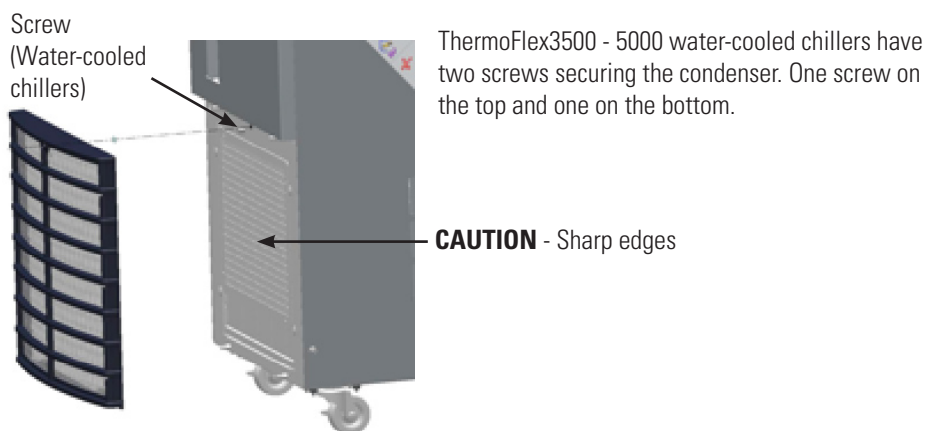

**Figure 6-3** ThermoFlex900 - 5000 Condenser Grill Removal

**ThermoFlex7500 - 10000**

For air-cooled chillers, remove the one-piece grill assembly by pulling the assembly away from the chiller.

Water-cooled chillers do not have a filter.

The filter goes over four studs and plastic "fast nuts" hold it in place.

Replace it or vacuum the old filter with a soft-bristle brush, or wash it. Shake off as much of the excess water as possible before reinstalling.

Tuck the filter around the perimeter of the grill and over the four studs, use the plastic "fast nuts" to hold it in place.

Replacement grills are available from Thermo Fisher.

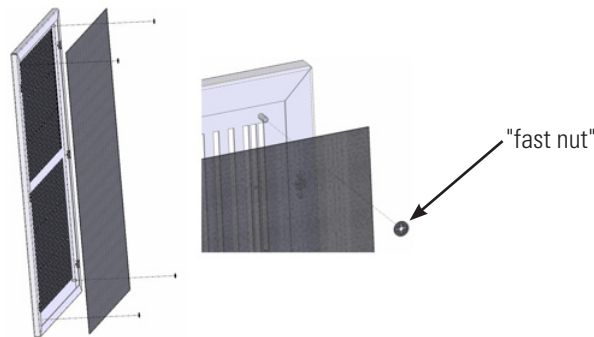

**Figure 6-4** Filter Removal/Replacement ThermoFlex7500 - 10000 Air-Cooled

**ThermoFlex15000 - 24000**

The air-cooled chillers do not have filters but the condenser fins can be cleaned by removing the eight screws securing the lower-front panel.

**Chiller Surface**

Clean the chiller's surface with a soft cloth and warm water only.

**Hoses**

Inspect the chiller's external hoses and clamps on a daily basis.



## DI Filter (Optional)

Establish a preventive maintenance schedule for the DI filter cartridge based on your specific application.

The Puralite sensor located on the back of your chiller will illuminate red when it is time to change the DI filter cartridge ( $< 1 \text{ M}\Omega\text{-cm}$ ).

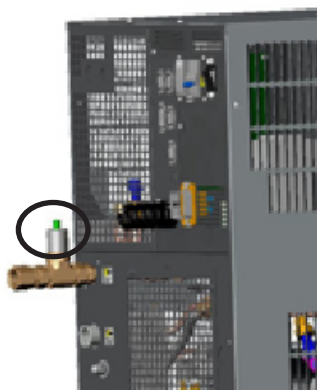

**Figure 6-5** Puralite

**Note** When the chiller is initially powered, or has been sitting idle for a period of time, the sensor may illuminate. The length of time it will be on varies with your application. ▲

Although the Puralite sensor is the primary indicator that the cartridge needs changing, the chiller also has a *separate* integrated alarm that works independently of the Puralite. The alarm is based on chiller run hours that will alert you when it is time to change your filter. The **di t** alarm is enabled using the Setup Loop, see Section 4.

If you already know how often your DI filter needs changing, you can input the number of hours into the Setup Loop's **di t** display. When the time is reached, the controller will flash **di** and the audible alarm, if enabled, will sound.

When alerted, check the Puralite sensor to see if it is illuminated. If it is not illuminated reset the **di t** timer and then check the Puralite periodically.

To clear this message and stop the audible alarm press  .

If the Puralite has turned red and the controller alarm has not gone off, access the Diagnostic Loop **di** display, see next page. Check the system run hours, this will give you an accurate DI replacement time. Adjust the **di t** filter alarm to match the time needed between filter cartridge changes.



This will automatically restart the preventive maintenance timer for your DI filter. If you change the filter before the preventive maintenance timer alerts you, you can clear the timer by again accessing the Diagnostic Loop **di** display, see next page.



**Note** It may be necessary to monitor the Puralite three or four times to establish an accurate changing schedule. Also, filter operating time is reduced every time new fluid is added. ▲



## Diagnostic Loop (d ,R9)

The Diagnostic Loop is used to view or reset the operating times of various chiller components.

To enter the Diagnostic Loop ensure the controller display is either a blank screen (chiller off) or displaying the process fluid temperature.

Press the  key and the display will indicate **SP**, press  again to display **SEtuP**, press  again to display **d ,R9**.

Press  to enter the loop or press  to return to the process fluid temperature or blank display.

Use the  key to sequence down through the loop. Use the  key to sequence up through the loop.

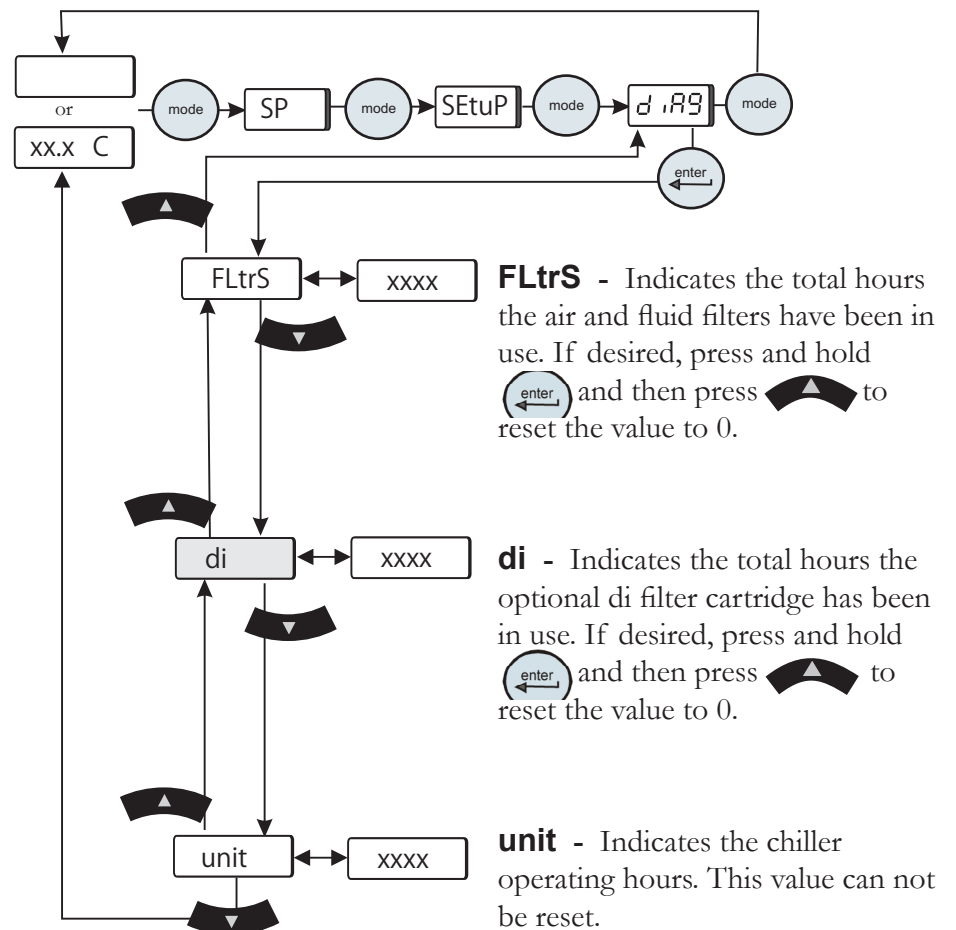

Figure 6-6 Diagnostic Loop

## **Testing the Alarm Features**

Using the Setup Loop, adjust each temperature alarm limit towards the setpoint and ensure the chiller reacts accordingly. Reset each alarm limit to the desired value. See Section 4.

Slowly drain the chiller's reservoir, see Section 8, and ensure the chiller shuts down. For chillers equipped with auto refill switch ensure the auto refill activates.

## Error Codes Section 7 Troubleshooting

The controller can display Error Codes. If the chiller is still running press **enter** to see if the code clears, a limit may have been only temporarily exceeded. If the chiller shut down, the controller will continue to flash the error code. Press **enter** to clear the display and silence any alarm. You can silence the alarm without clearing the code by pressing either the up or down arrow key. Once the cause of the shut down is identified and corrected, start the chiller. If the cause was not corrected the error code will reappear. Contact our Sales, Service and Customer Support.

Error Code	Reaction	Cause	Actions
<b>8888</b> (or blank screen)	Chiller will not start.	Software communication error.	<ul style="list-style-type: none"> <li>•Cycle circuit protector on the rear of the chiller, ThermoFlex900-10000 only.</li> </ul>
<b>Add</b>	Chiller continues to run. Auto refill, if installed, shuts off.	The auto refill time chosen for the customer adjustable <i>fill</i> setting in the Setup Loop is set to 0 and the chiller is configured to keep running, see Section 4.	<ul style="list-style-type: none"> <li>•Check for leaks.</li> <li>•Check <b>reFill</b> settings and adjust if necessary, see Section 4.</li> <li>•Add fluid to the tank.</li> </ul>
<b>di</b>	Chiller continues to run. (Optional display)	The chiller operating time exceeded Setup Loop di t alarm value. The optional DI cartridge <i>may</i> need replacing.	<ul style="list-style-type: none"> <li>•Check the Puralite sensor, see Section 6. If the light is red change the cartridge, see Section 5.</li> <li>•If the Puralite sensor is green, see Section 4 to revise <b>di t</b> alarm value.</li> </ul>
<b>driP</b>	Chiller will shut down. (Optional display)	Fluid in drip pan (SEMI only).	<ul style="list-style-type: none"> <li>•Check for leaks.</li> <li>•Remove the fluid from the drip pan and reset the fault.</li> </ul>
<b>FLO-LoFLO</b>	Chiller continues to run.	The low flow alarm is set to 0.0 and the pump flow rate is below the minimum required, see Section 4.	<ul style="list-style-type: none"> <li>•See <b>LoFLO</b> error code.</li> </ul>
<b>FLtrS</b>	Chiller continues to run.	Air and fluid filters require preventive maintenance/replacement.	<ul style="list-style-type: none"> <li>•Check air and fluid filters. If required, clean/change air and fluid filters, see Section 6.</li> <li>•If your filters do not need cleaning, you may increase the number of hours between preventive care reminders. There are four levels, see Section 6.</li> </ul>

Error Code	Reaction	Cause	Actions
<b>HiFLO</b>	Chiller reaction depends on <b>ALR</b> setting chosen in the Setup Loop, see Section 4. (Chiller equipped with a flow transducer.)	The process fluid flow rate has exceeded the adjustable high flow setting's value.	<ul style="list-style-type: none"> <li>• If the chiller is still running press enter to see if the code clears, the limit may have been only temporarily exceeded.</li> <li>• Verify your <b>HiFLO</b> setting, see Section 4, and adjust setting if necessary.</li> <li>• Check all application and plumbing shut off valves for correct position.</li> <li>• Adjust flow if chiller is equipped with an optional flow control valve, see Section 5.</li> <li>• If flow transducer was recently calibrated double check calibration, see Section 8.</li> </ul>
<b>Hi P1</b>	Chiller reaction depends on <b>ALR</b> setting chosen in the Setup Loop, see Section 4.	The pump's high discharge pressure exceeded Setup Loop high alarm value.	<ul style="list-style-type: none"> <li>• If the chiller is still running press enter to see if the code clears, the limit may have been only temporarily exceeded.</li> <li>• Verify your <b>Hi P1</b> setting, see Section 4.</li> <li>• Check application valves and ensure that they have not changed or closed. <b>Note</b> If routine shut-off of the process flow is required then add an external pressure relief valve, see Section 5. ▲</li> <li>• May occur as a result of changing the internal DI cartridge. Disconnecting the cartridge adds an additional 0.5 gpm to the main flow. See Section 5.</li> <li>• Check for debris in the application or external filters.</li> <li>• Double check fluid lines. Excessive bends, long tubing and diameter reductions can affect the pump's discharge pressure. <b>Note</b> If diameter reductions must be made, make them at the inlet and outlet of your application, not at the chiller. ▲</li> </ul>

Error Code	Reaction	Cause	Actions
<b>Hi t</b>	Chiller reaction depends on <b>ALr</b> setting chosen in the Setup Loop, see Section 4. <b>Note</b> If the chiller does shut down it can be restarted provided the temperature is still within the factory-set high fixed temperature limit. However, the error will reoccur if the temperature goes below the adjustable setting and then again exceeds it. ▲	The process fluid temperature exceeded Setup Loop alarm value.	<ul style="list-style-type: none"> <li>• If the chiller is still running press enter to see if the code clears, the limit may have been only temporarily exceeded.</li> <li>• Verify your <b>Hi t</b> setting, see Section 4.</li> <li>• Ensure the chiller meets all environmental requirements, see Section 3.</li> <li>• Clean the air filter. Dirt and debris on the filter can prevent the chiller from functioning at full capacity, see Section 6.</li> <li>• Ensure that the heat load being applied to the chiller is not too high. Contact Thermo Fisher for assistance on calculating heat loads.</li> <li>• Bring cooler air in from another area or exhaust the hot air into another location using an auxiliary fan.</li> <li>• Verify/adjust controller PID values, see the end of this section.</li> </ul>
<b>HPC</b>	Chiller will shut down.	High refrigeration pressure.	<p><b>Air-cooled chillers</b></p> <ul style="list-style-type: none"> <li>• Ensure that the ambient temperature is not exceeding the recommended range, see Section 3.</li> <li>• Ensure chiller has adequate ventilation, see Section 3.</li> <li>• Clean the air filter. Dirt and debris on the filter can prevent the filter from functioning at full capacity, see Section 6.</li> <li>• Bring cooler air in from another area or exhaust the hot air into another location using an auxiliary fan.</li> </ul> <p><b>Water-cooled chillers</b></p> <ul style="list-style-type: none"> <li>• Ensure the plastic plugs were removed from the facility connections.</li> <li>• Ensure facility water is on and connected.</li> <li>• Check facility water flow rate and pressure.</li> </ul>

Error Code	Reaction	Cause	Actions
<b>LLF</b>	Chiller will shut down.  Optional auto refill shuts down.	Reservoir fluid level too low for normal operation.  The auto refill time chosen for the customer adjustable <i>fill</i> setting in the Setup Loop is set to 0 and the chiller is configured to shut down, see Section 4.	<ul style="list-style-type: none"> <li>•Excessive evaporation. Ensure the chiller is operating with the funnel and cap in place.</li> <li>•Check for leaks.</li> <li>•Check <b>rEFil</b> settings and adjust if necessary, see Section 4.</li> <li>•Add fluid to the tank.</li> </ul>
<b>LoFlo</b>	Chiller reaction depends on <b>ALr</b> setting chosen in the Setup Loop, see Section 4.  (Chillers equipped with a flow transducer.)	The process fluid flow rate has gone below the adjustable setting's value.	<ul style="list-style-type: none"> <li>•If the chiller is still running press enter to see if the code clears, the limit may have been only temporarily exceeded.</li> <li>•Verify your <b>LoFlo</b> setting, see Section 4.</li> <li>•Adjust flow if chiller is equipped with an optional flow control valve, see Section 5.</li> <li>•Check all valves in your application and plumbing lines to ensure that they have not changed or closed.</li> <li>•If flow transducer has recently been calibrated, double check calibration to ensure it was done properly, see Section 8.</li> </ul>
<b>Lo P1</b>	Chiller reaction depends on <b>ALr</b> setting chosen in the Setup Loop, see Section 4.	Pump's low discharge pressure is below Setup Loop low alarm value.	<ul style="list-style-type: none"> <li>•If the chiller is still running press enter to see if the code clears, the limit may have been only temporarily exceeded.</li> <li>•Ensure that chiller reservoir level is not too low.</li> <li>•Verify your <b>LoP1</b> setting, see Section 4.</li> <li>•Chiller requires &gt;3 PSIG application pressure drop. If a bypass valve has been installed, some restriction may need to be added to the bypass line.</li> </ul>



Error Code	Reaction	Cause	Actions
<b>Lo t</b>	Chiller reaction depends on <b>ALr</b> setting chosen in the Setup Loop, see Section 4. <b>Note</b> If the chiller does shut down it can be restarted provided the temperature is still above the factory-set low fixed temperature limit. However, the error will reoccur if the temperature goes above the adjustable setting and then again drops below it. ▲	Process fluid temperature is below Setup Loop alarm value.	<ul style="list-style-type: none"> <li>• If the chiller is still running press enter to see if the code clears, the limit may have been only temporarily exceeded.</li> <li>• Verify your <b>Lo t</b> setting, see Section 4.</li> <li>• Ensure that the ambient temperature is not below the recommended low-range, see Section 3. If your application load is constant and/or the lower temperature can be temporarily tolerated, then continue operation. (The ThermoFlex will control setpoint when sufficient heat is added.)</li> <li>• Verify/adjust controller PID values.</li> <li>• Add insulation to external plumbing lines to reduce the heat-loss to the environment.</li> <li>• For water-cooled chillers check facility water temperature.</li> </ul>
<b>o FLo</b>	Chiller will shut down.	There is an overflow condition in the reservoir.	<ul style="list-style-type: none"> <li>• Ensure the reservoir was not filled above the MAX LEVEL line.</li> <li>• Check for clogged reservoir filter.</li> </ul>
<b>oL</b>	Chiller will shut down. (Chillers equipped with 3-Φ pump motor overload.)	Pump motor overload activated. Pump motor exposed to excessive current due to high pressure, flow or ambient temperature.	<ul style="list-style-type: none"> <li>• Allow pump to cool down.</li> </ul>
<b>oL 2</b>	Chiller will shut down. (Chillers equipped with 3-Φ fan.)	Fan motor overload activated.	<ul style="list-style-type: none"> <li>• Allow chiller to cool down.</li> <li>• For air-cooled chillers, clean the air filter</li> </ul>
<b>PHER</b>	Chiller will shut down. (3-Φ chiller only)	Phase rotation is wrong.	<ul style="list-style-type: none"> <li>• Disconnect chiller from power source and reverse any two line conductors on the line side of the main circuit breaker.</li> </ul>

Error Code	Reaction	Cause	Actions
<b>rEFIL</b>	Auto refill will shut off. Chiller reaction depends on <b>ALR</b> setting chosen in the Setup Loop, see Section 4.  Auto refill will shut off. Chiller will continue to run. (Optional display.)	The fluid level did not reach the minimum operating level within the time chosen for the customer adjustable <i>fill</i> settings, chosen in the Setup Loop, see Section 4.  The auto refill successfully filled within the time frame chosen for the customer adjustable <i>fill</i> setting, but the chiller tried to refill 5 times in 40 hours.	<ul style="list-style-type: none"> <li>•Check auto refill connection.</li> <li>•Check for leaks.</li> <li>•Check the supply pressure on the auto refill supply line. With low pressure the auto refill time span setting may be set too low and the reservoir does not have time to fill.</li> <li>•Check <b>rEFIL</b> settings and adjust if necessary, see Section 4.</li> </ul>
<b>SEr 1</b>	Chiller will continue to run.	Periodic service may be required.	<ul style="list-style-type: none"> <li>•To clear the message see Section 8.</li> </ul>
<b>Er 4</b>	Chiller will not start.	Normal if new software installed and all values in the Setup and Tune Loops were reset to factory defaults.	<ul style="list-style-type: none"> <li>•Clear the error code.</li> </ul>
<b>Er 15</b>	Chiller will continue to run. (Chiller equipped with serial communications.)	Momentary disruption of the internal communications to control board.	<ul style="list-style-type: none"> <li>•Clear the error code</li> </ul> Check the serial communication connection. <ul style="list-style-type: none"> <li>•See serial communication connections in Appendix D.</li> </ul>
<b>Er 16</b>	Chiller continues to run.	Bad sensor calibration detected several seconds after performing a calibration.	<ul style="list-style-type: none"> <li>•Redo calibration, see Section 8.</li> </ul>

Error Code	Reaction	Cause	Actions
<b>Er 22</b>	This error code has priority over <b>HIT</b> . Chiller will shut down.  <b>Note</b> Chiller will not restart until process fluid temperature is below +43°C. ▲	Reservoir fluid temperature exceeded the <i>factory preset</i> value of +43°C.	<ul style="list-style-type: none"> <li>•Ensure the chiller meets all environmental requirements, see Section 3.</li> <li>•Clean the air filter. Dirt and debris on the filter can prevent the chiller from functioning at full capacity, see Section 6.</li> <li>•Ensure that the heat load being applied to the chiller is not too high. Contact Thermo Fisher for assistance on calculating heat loads.</li> <li>•Bring cooler air in from another area or exhaust the hot air into another location using an auxiliary fan.</li> <li>•Verify/adjust controller PID values, see the end of this section.</li> <li>•Contact our Sales, Service and Customer Support.</li> </ul>
<b>Er 23</b>	Chiller will shut down.	Refrigeration temperature sensor shorted.	•Contact our Sales, Service and Customer Support.
<b>Er 24</b>	Chiller will shut down.	Refrigeration temperature sensor open.	•Contact our Sales, Service and Customer Support.
<b>Er 25</b>	Chiller will shut down.	Internal temperature sensor shorted.	•Contact our Sales, Service and Customer Support.
<b>Er 26</b>	Chiller will shut down.	Internal temperature sensor open.	•Contact our Sales, Service and Customer Support.
<b>Er 28</b>	Chiller continues to run.	The process fluid resistivity exceeded the lower adjustable value.	<ul style="list-style-type: none"> <li>•Press enter to see if the code clears, the limit may have been only temporarily exceeded.</li> <li>•Verify controller's settings, see Section 4</li> <li>•Replace process fluid.</li> </ul>
<b>Er 30</b>	Chiller continues to run.	The process fluid resistivity exceeded the higher adjustable value.	<ul style="list-style-type: none"> <li>•Press enter to see if the code clears, the limit may have been only temporarily exceeded.</li> <li>•Verify controller's settings, see Section 4</li> <li>•Replace process fluid.</li> </ul>
<b>Er 32</b>	Chiller will shut down.	Refrigeration suction gas temperature exceeded 50°C.	<ul style="list-style-type: none"> <li>•Make sure supply voltage matches the chiller's nameplate rating <math>\pm 10\%</math>.</li> </ul>

Error Code	Reaction	Cause	Actions
<b>Er 33</b>	This error code has priority over <b>LoT</b> . Chiller will shut down. <b>Note</b> Chiller will not restart until process fluid temperature exceeds +2°C. ▲	Reservoir fluid temperature below the <i>factory preset</i> value of +2°C.	<ul style="list-style-type: none"> <li>• Check ambient temperature. Chiller may not be able to reach setpoint at low ambient temperatures.</li> <li>• Ensure that the ambient temperature is not exceeding the recommended range, see Section 3.</li> <li>• Verify/adjust controller PID values, see Section 7.</li> <li>• Add insulation to external plumbing lines to reduce the heat-loss to the environment.</li> <li>• For water-cooled chillers check facility water temperature.</li> </ul>
<b>Er 35</b>	This error code has priority over <b>Hi P1</b> . Chiller will shut down.	Process pressure (P1) exceeded <i>factory preset</i> value for greater than 30 seconds. Preset Values: T0, T1 and T5- 105 psi P1 and P2 - 105 psi P3 60 Hz - 48 psi P3 50 Hz - 32 psi P4 60 Hz - 85 psi P4 50 Hz - 60 psi P5 60 Hz - 87 psi P5 50 Hz - 56 psi	<ul style="list-style-type: none"> <li>• Check application valves and ensure that they have not changed or been closed. <b>Note</b> If routine shut-off of the process flow is required then add an external pressure regulator accessory - contact Thermo Fisher. ▲</li> <li>• May occur as a result of changing the internal DI cartridge. Disconnecting the cartridge adds an additional 0.5 GPM to the main flow, see Section 5.</li> <li>• Check for debris in the application or clogged external filters.</li> <li>• Double check fluid lines. Excessive bends, long tubing and diameter reductions can affect the pump's discharge pressure. <b>Note</b> If diameter reductions must be made, make them at the inlet and outlet of your application, not at the chiller. ▲</li> </ul>
<b>Er 36</b>	This error code has priority over <b>Lo P1</b> . Chiller will shut down.	Process pressure (P1) below <i>factory preset</i> limit of 2 psi (all pumps) for greater than 15 seconds. Possible pump motor overload.	<ul style="list-style-type: none"> <li>• Ensure that the chiller reservoir is not too low.</li> <li>• Chiller requires &gt;2 PSIG application pressure drop. If a bypass valve has been installed, some restriction may need to be added to the bypass line.</li> <li>• Allow chiller to cool down</li> </ul>

Error Code	Reaction	Cause	Actions
<b>Er 41</b>	Chiller continues to run.	Momentary communication error between display and main control board.	<ul style="list-style-type: none"> <li>•If using Analog I/O ensure your communication cable is properly shielded from electrical noise, see Appendix C.</li> <li>•Cycle circuit protector on rear of chiller off and on, ThermoFlex900-10000 only.</li> <li>•Contact our Sales, Service and Customer Support.</li> </ul>
<b>Er 42</b>	Chiller continues to run.	Momentary internal communications error.	<ul style="list-style-type: none"> <li>•When able, reset the EMO.</li> </ul>
<b>Er 47</b>	Chiller will shut down.	Chiller's optional remote EMO button depressed.	<ul style="list-style-type: none"> <li>•When able, reset the EMO.</li> </ul>
<b>Er 48</b>	Chiller will shut down. (Optional display.)	Chiller's optional EMO button depressed.	<ul style="list-style-type: none"> <li>•When able, reset the EMO.</li> </ul>
<b>Er 59</b>	Chiller will shut down.	Invalid level fault. Chiller sensed both a high level and low level reservoir fluid level.	<ul style="list-style-type: none"> <li>•Contact our Sales, Service and Customer Support.</li> </ul>
<b>Er 62</b>	Chiller will not start. (Chillers equipped with optional Analog I/O.)	Probe not properly connected. Shorted remote temperature probe.	<ul style="list-style-type: none"> <li>•Check connection.</li> </ul>
<b>Er 63</b>	Chiller will not start. (Chillers equipped with optional Analog I/O.)	Probe not properly connected. Open remote temperature probe.	<ul style="list-style-type: none"> <li>•Check connection.</li> </ul>
<b>Er 64</b>	Chiller will continue to run Chiller the last valid setpoint received. (Chillers equipped with optional Analog I/O.)	Analog remote setpoint is enabled and the chiller receives a voltage or current level that is outside the chiller's set point range.	<ul style="list-style-type: none"> <li>•The error can be cleared only after a valid set point is received, or the remote analog setpoint is turned off.</li> </ul>

## Checklist

### Chiller will not start

Check electrical connections.

For first time use, please refer to the quick start instructions included with your chiller or the copy in this manual. The manual's copy follows the Table of Contents.

Check the controller for error codes, see Error Codes in this Section.

Ensure the optional GFCI breaker located on the rear of the chiller is in the up position.

For ThermoFlex900 - 10000 chillers ensure the circuit protector is in the on (I) position.

Make sure supply voltage is connected and matches the chiller's nameplate rating  $\pm 10\%$

### No display on controller or display is 8888

For ThermoFlex900 - 10000 recycle the circuit protector on the rear of the chiller.

### Clearing Error Codes

Note the code in case it clears before you are done troubleshooting.

If desired, silence the alarm by pressing the up or down arrow key.

*If the chiller shut down*, the controller will continue to flash the error code. Press **enter** to clear the display and silence any alarm. Refer to Error Codes in this Section. Once the cause of the shut down is identified and corrected, start the chiller. If the cause was not corrected the error code will reappear.

*If the chiller is still running*, press **enter** to see if the code clears, a limit may have been only temporarily exceeded. If the error code does not clear press  until the display flashes between the error code and the temperature and then press **enter**. If the code still does not clear refer to Error Codes in this Section.

**Chiller shuts down**

Ensure  button wasn't accidentally pressed.

Ensure the optional GFCI breaker located on the rear of the chiller is in the up position.

For ThermoFlex900 - 10000 chillers ensure the circuit protector is in the on ( I ) position.

Check the controller for error codes, see Error Codes in this Section.

The chiller is designed to shut down if not properly primed, refer to Section 3 for priming instructions.

Make sure supply voltage is connected and matches the chiller's nameplate rating  $\pm 10\%$ .

Restart the chiller.

**Inadequate pump pressure**

Ensure any user installed in-line valves are in the desired position.

Ensure the chiller's process fluid outlet is connected to the application's fluid inlet and not the application's fluid outlet, see Section 3.

Ensure all connections are secure and that the proper sealant/lubricant for the fitting material is used.

Keep the distance between the chiller and the instrument being cooled as short as possible.

Ensure tubing is straight and without bends. If diameter reductions are required, make them at the inlet and outlet of your application, not at the chiller.

**Chiller will not circulate process fluid**

Check the reservoir level. Fill, if necessary.

Ensure the reservoir bag filter is not clogged.

Check the application for restrictions in the cooling lines.

Chiller requires  $>3$  PSIG application pressure drop. If a bypass valve has been installed add some restriction to the bypass line.

The pump motor overloaded. The pump's internal overtemperature overcurrent device will shut off the pump causing the flow to stop. This can be caused by low fluid, debris in system, operating chiller in a high ambient temperature condition or excessively confined space. Allow time for the motor to cool down.

Make sure supply voltage matches the chiller's nameplate rating  $\pm 10\%$ .



### **Inadequate temperature control**

Verify the setpoint.

If the chiller is over-cooling, recycle the power.

Make sure the condenser/air filter is free of dust and debris.

Check the fluid concentration, see Section 3.

Ensure chiller installation complies with site requirements, see Section 3.

Make sure supply voltage matches chiller nameplate rating  $\pm 10\%$ .

For ThermoFlex900 - 5000 global voltage chillers ensure the chiller is properly configured, see Appendix B.

If the temperature continues to rise, make sure your application's heat load does not exceed the rated specifications.

Check for high thermal gradients (e.g., the application load is being turned on and off or rapidly changing).

Verify/adjust controller PID values, see next page.

### **Chiller vibration**

The optional pressure relief valve setting may be the cause. Change the pressure setting  $\pm 5$  psi to eliminate the vibration.

Please contact Thermo Fisher Scientific Sales Service and Customer Support if you need any additional information, see this manual's inside cover for contact instructions.

# Verifying/ Adjusting the Controller PID Values (Tune Loop)

The controller controls temperature using a Proportional-Integral-Derivative (PID) algorithm. Should your chiller experience temperature control issues, verifying/adjusting the controller's PID values may correct the condition.

**Note** Thermo Fisher recommends that only a qualified technician adjust the PID values. Incorrect values will hamper chiller performance. ▲

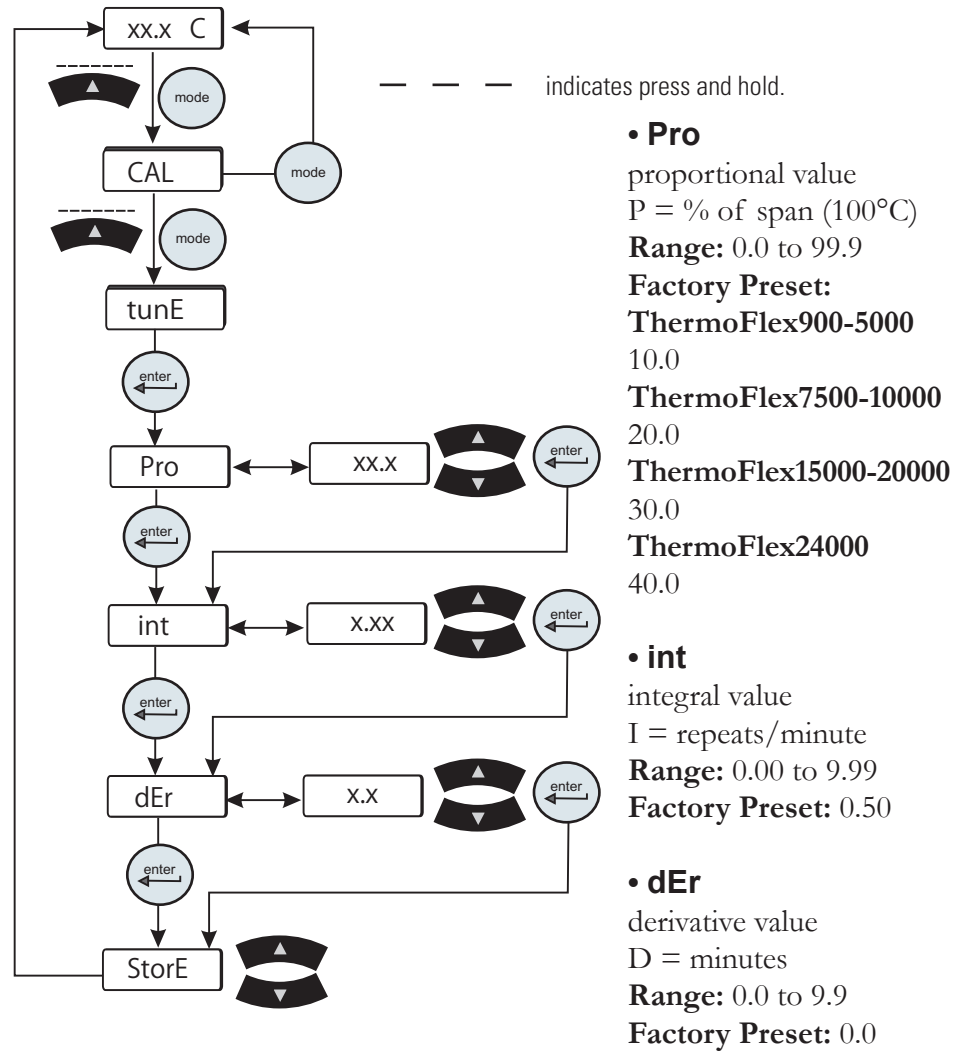

**Figure 7-1** Verifying/Adjusting PID Values



## Draining



# Section 8 Additional Information

Before using any fluid or performing maintenance where contact with the fluid is likely refer to the manufacturer's MSDS. ▲

There are two different types of drain port, a 1/4" brass Male NPT pipe plug or a 1/4" MPT Riton fitting. If your chiller has both use the Riton fitting.

Position a suitable pan beneath the drain port at the rear of the chiller. The drain pan must be shallow (under 3 1/2" in height) and have a volume of approximately 3 gallons (6 gallons for ThermoFlex7500 - 24000). Remove the 1/4" Male NPT pipe plug from drain port or open the Riton fitting by turning either counter clock wise. For ThermoFlex7500-24000, open the drain valve. This will drain the return line, reservoir, plate exchanger, and the suction side of the pump.

To drain the discharge side of the pump disconnect the Female NPT outlet connection on the rear of the chiller.

**Note** Internally the chiller does not contain a large quantity of fluid on the discharge side however take care to contain what fluid does drain, a wet-vac can be employed to minimize the potential for spillage. ▲

If the chiller is equipped with the flow control or pressure relief with flow control option, open the valve or remove the drain plug in order to drain the discharge line, see Section 5.

If the chiller is equipped with the anti drainback option, enter the Setup Loop and utilize the **drAin** display to open the valve, see Section 4. Opening the valve allows the fluid to drain out of the chiller.

Reinstall 1/4" Male NPT pipe plug using a sealant suitable for the wetted materials or close the Riton filling prior to refilling.



**Do not overtighten the fitting.** ▲

For ThermoFlex7500-24000, close the drain valve.

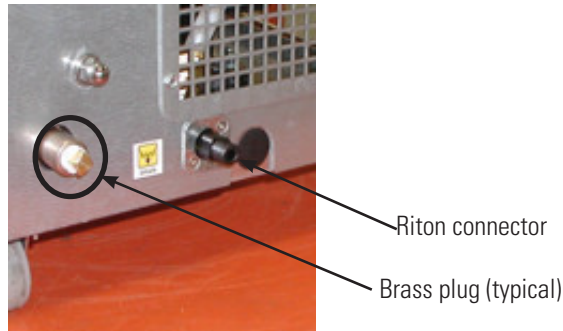

**Figure 8-1** Drains

### Water-Cooled

Draining ThermoFlex1400 - 2500 water-cooled chillers is accomplished by removing the right side panel. Use a Phillips head screwdriver to remove the five screws indicated in the illustration below. Slide the panel back approximately one inch, then lift slightly from the rear to disengage the panel's two tabs from their slots.



The drain for ThermoFlex3500 and 5000 is located behind the condenser filter.

The drain for ThermoFlex7500 and 10000 is located behind the access panel on the lower left front of the chiller. The panel has two ¼ turn fasteners (cross head).

The drain for Thermoflex15000 - 24000 is a ¼" plug located on the rear of the chiller.

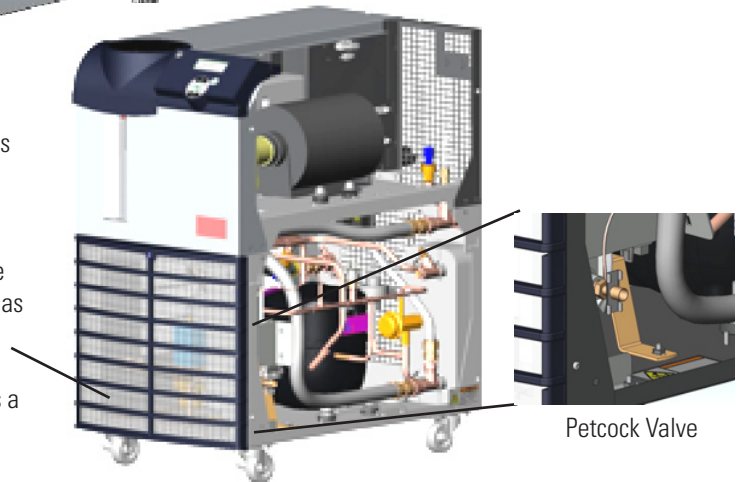

**Figure 8-2** Water-Cooled

Install a  $\frac{7}{16}$ " ID tube on the drain petcock valve located on the lower end of the exchanger. Open the valve to allow fluid to drain into an external device. When draining is complete close the valve and replace the panel.

A wet-vac is needed on the facility water inlet connection to thoroughly drain any remaining fluid from the lines.

**Wetted Materials****P1, P2, MD1 and MD2 Pumps**

303 Stainless Steel

Ultem®

Carbon Graphite

Ceramic

Fluorocarbon (Viton®)

Brass

**P3 Pumps**

316 Series Stainless Steel

Carbon

Silicon Carbide

Fluorocarbon (Viton®)

**P4 Pumps**

304 Stainless Steel

Carbon Ceramic

Fluorocarbon (Viton®)

**P5 Pumps**

304, 316 Series Stainless Steel

Carbon Ceramic

Fluorocarbon (Viton®)

**T0 Pumps**

Stainless Steel AISI 304

Stainless Steel 316, 18-8

Bronze ASTM B62 and B12

Buna N

Buna/Ceramic and Carbon

Fluorocarbon (Viton®)

Silicon Brass

**Filter bag**

Polypropylene

Mono-filament nylon

**Cap and Funnel**

Acetal Copolymer

**T1 Pumps**

Stainless Steel AISI 304

Stainless Steel 316, 18-8

Bronze ASTM B62 and B16

Buna N

Silicon Carbide and Brass

Fluorocarbon (Viton®)

**T5 Pumps**

Silicon Brass

Stainless Steel AISI 304

Stainless Steel 316, 18-8

Bismuth Bronze

Buna N

Carbon/Ceramic

Viton

**Plumbing**

300 Series Stainless Steel

Bronze

Fluorocarbon (Viton®)

Nickel

Polypropylene

EPDM

Brass

Copper

Teflon®

PPS (flow transducer)

Nitrile (Buna-n®)

Riton® (optional drain fitting)

**Tank**

Polyethylene

Brass

EPDM

Pyrex®

## Internal Fluid Temperature Sensor (rdt1) Calibration

The ThermoFlex has been designed to minimize the need for calibration. However, if calibration is desired or recommended by our Sales, Service and Customer Support, please use the following procedure.



This procedure requires a running chiller and a calibrated reference thermometer.





**Note** Uninsulated applications may cause the internal temperature and an external reference temperature to differ and to fluctuate. If inaccurate calibration is suspected, place the reference thermometer as close to the ThermoFlex process outlet as possible. ▲

**Note** If it is more convenient, perform the low-end calibration before doing the high-end. ▲



Do not pick calibration points that are outside the safe operating limits of the fluid in your application. For example with water, 40°C and 5°C are typical high and low calibration points.



Run the temperature to a suitable high-end calibration point. Place a calibrated reference thermometer in the reservoir. Ensure the fluid temperature is stabilized.

To enter the Calibration Loop ensure the controller display is displaying the process fluid temperature, see the diagram on next page. Press and hold the  and then press the  key. The display will indicate **CAL**.

Press the  key and the controller will display **rdt1**. Press  again and the controller will display **r1 H** (high-end calibration). Press  again and the controller will flash between **r1 H** and the temperature. Use  to adjust the temperature to match the reference thermometer.

Press the  key again to accept the value.

Press the  key until **Store** is displayed, press  to save the new value, press  to not save it.

**Note** After pressing the  button at the **Store** prompt wait several seconds before proceeding to ensure that a bad calibration message (**Er 16**) does not appear. Premature use of the keypad after pressing  may cancel the bad calibration error message. ▲

Run the temperature to a suitable low-end calibration point. At the **r1 L** (low-end calibration) display repeat the procedure.



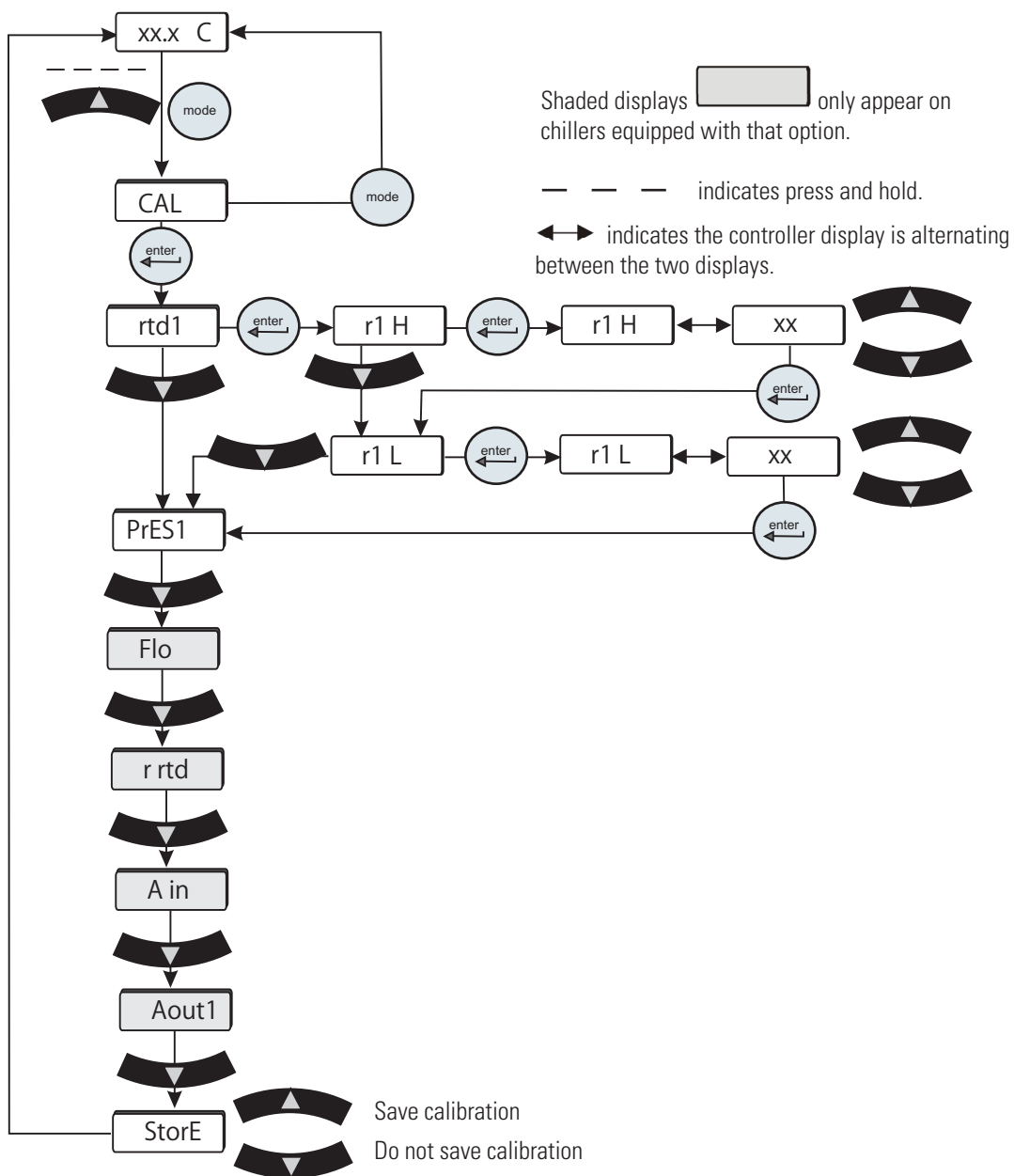

**Figure 8-3** Internal Temperature Sensor Calibration



If you have any questions please contact Thermo Fisher Scientific's Sales, Service and Customer Support.



## Process Fluid Pressure (P1) Transducer Calibration

The ThermoFlex has been designed to minimize the need for calibration. However, if calibration is desired or recommended by our Sales, Service and Customer Support, please use the following procedure.

This procedure requires a running chiller, a calibrated reference pressure gauge and an external flow control valve.

Connect a calibrated reference pressure gauge to the outlet line. Using an external flow control valve, increase the pressure to a suitable high-end calibration point by closing the valve. Ensure the pressure is stabilized.

To enter the Calibration Loop ensure the controller display is displaying the process fluid temperature, see the diagram on the next page. Press and hold the  and then press the  key. The display will indicate **CAL**.

Press the  key and the controller will display **rtd1**. Press  until the controller displays **PrES1**. Press  and the controller will flash between **P1H** and the pressure.



Use  to adjust the rate to match the reference pressure gauge.

Press the  key to accept the value.

Decrease the pressure to a suitable low-end calibration point (avoid a zero pressure). Ensure the pressure is stable.

The controller will flash between **P1L** and the pressure. Use  to adjust the rate to match the reference pressure gauge.

Press the  key and **StorE** is displayed, press  to save both values, press  to not save them.

**Note** After pressing the  button at the **StorE** prompt wait several seconds before proceeding to ensure that a bad calibration message (**Er 16**) does not appear. Premature use of the keypad after pressing  may cancel the bad calibration error message. ▲

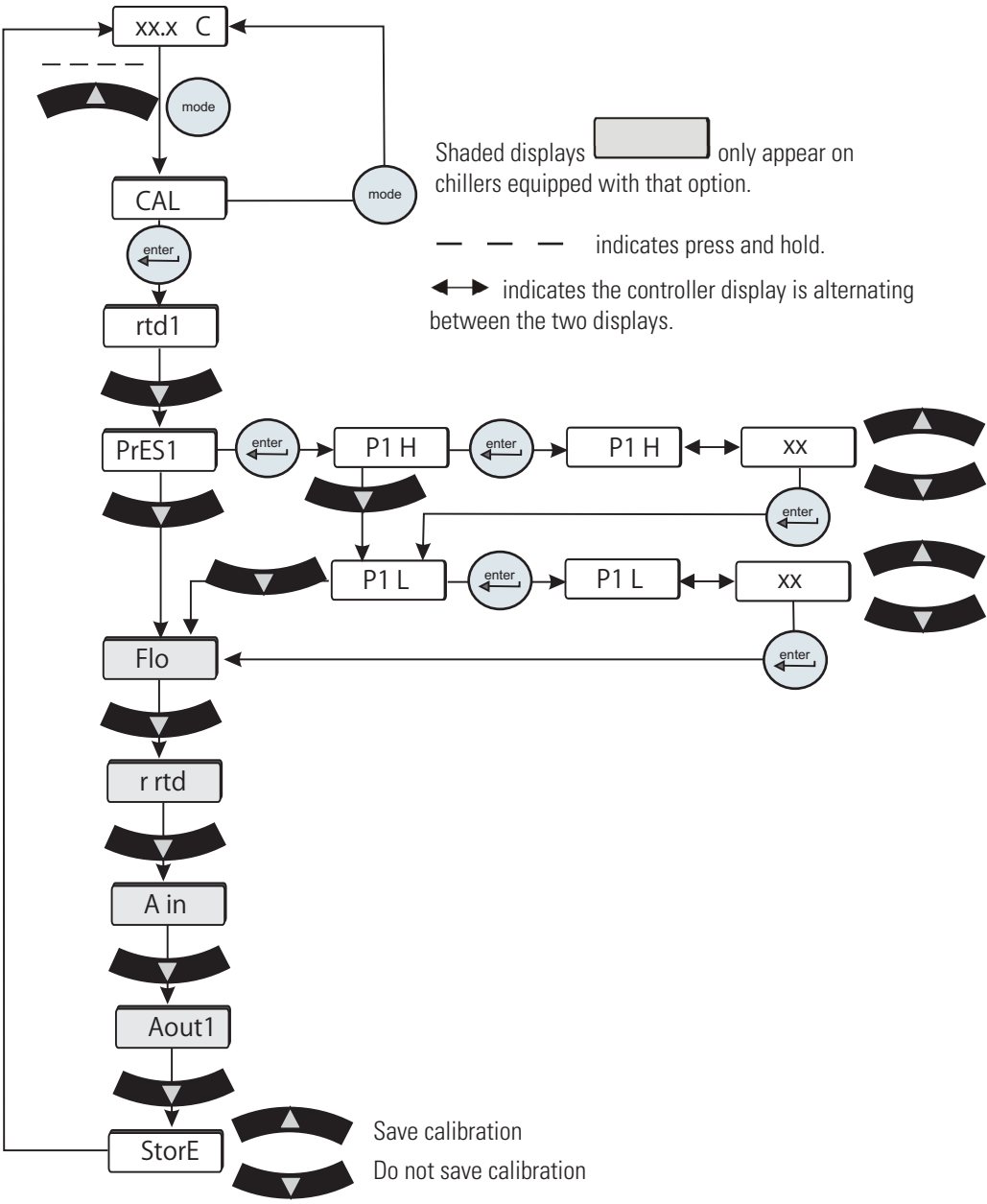

**Figure 8-4** Pressure (P1) Calibration



If you have any questions please contact Thermo Fisher Scientific's Sales, Service and Customer Support.



## Optional Process Fluid Flow Transducer (FLo) Calibration

The ThermoFlex has been designed to minimize the need for calibration. However, if calibration is desired or recommended by our Sales, Service and Customer Support, please use the following procedure.

This procedure requires a running chiller, a calibrated reference flowmeter and an external flow control valve.

Connect a calibrated reference flowmeter to the outlet line. Using an external flow control valve, increase the flow to a suitable high-end calibration point. Ensure the flow is stabilized.

To enter the Calibration Loop ensure the controller display is displaying the process fluid temperature, see the diagram on the next page. Press and hold the  and then press the  key. The display will indicate **CAL**.



Press the  key and the controller will display **rtd1**. Press  until the controller displays **FLo**. Press  and the controller will flash between **HiFLo** and the flow rate.



Use  to adjust the rate to match the reference flowmeter.

Press the  key to accept the value.

Decrease the flow to a suitable low-end calibration point (avoid a zero flow rate). Ensure the flow is stable.

The controller will flash between **LoFLo** and the flow rate. Use  to adjust the rate to match the reference flowmeter.

Press the  key and **StorE** is displayed, press  to save both values, press  to not save them.

**Note** After pressing the  button at the **StorE** prompt wait several seconds before proceeding to ensure that a bad calibration message (**Er 16**) does not appear. Premature use of the keypad after pressing  may cancel the bad calibration error message. ▲

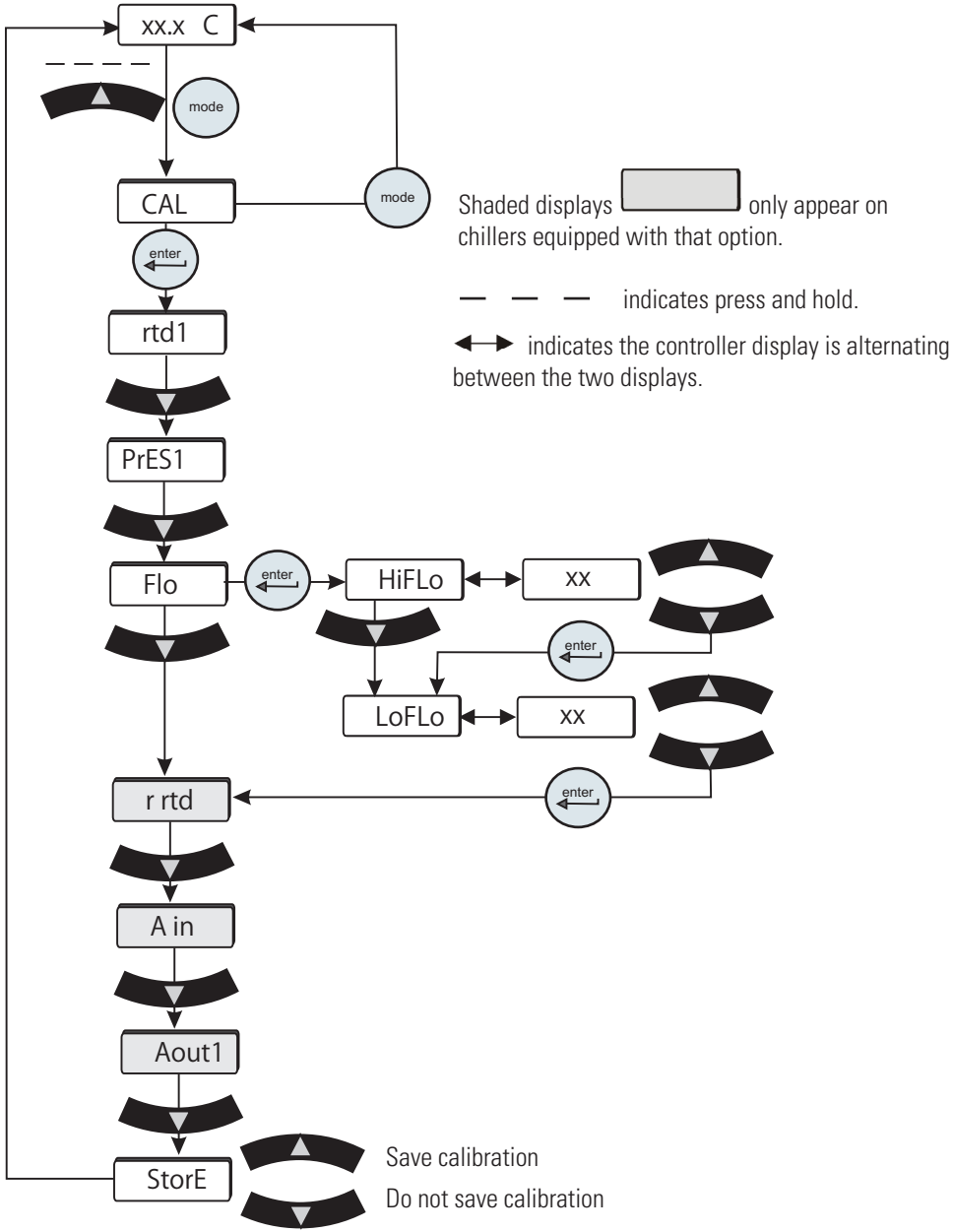

**Figure 8-5** Flow Transducer (FLo) Calibration

If you have any questions please contact Thermo Fisher Scientific's Sales, Service and Customer Support.

## Clearing SEr1 Message

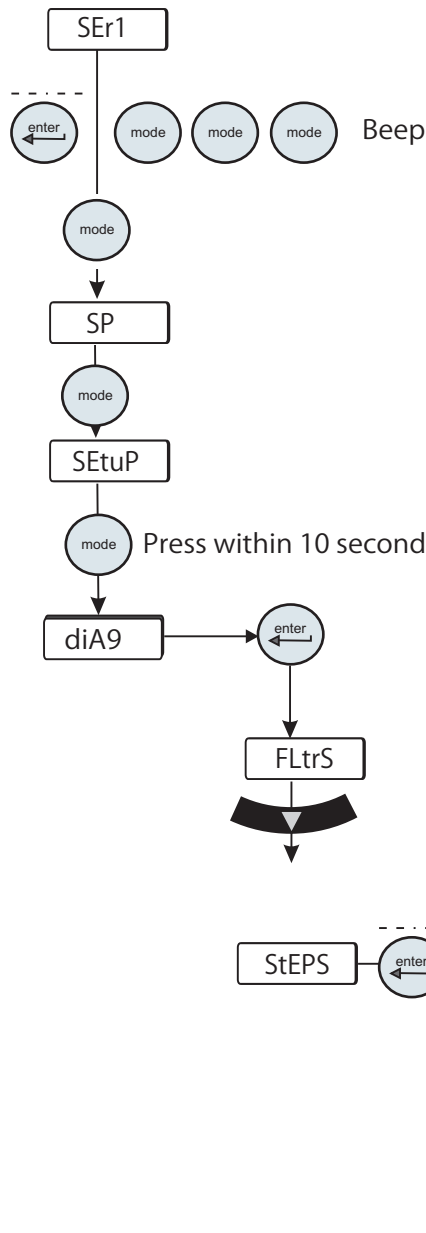

With **SEr1** flashing press and hold enter and then press mode three times, the controller should beep.

Press the mode key until **diA9** is displayed. Press enter.

Press the down arrow (approximately 11 times) until **StEPS** is displayed.

Press and hold enter and then press the up arrow, the display will show **0**.

Press the down arrow to return to the temperature display.

**Figure 8-6** Clearing Service Message

## Decommissioning/ Disposal



Laboratory Grade Ethylene glycol (EG) is poisonous and flammable. Before disposing refer to the manufacturer's most current MSDS for handling precautions. ▲



Decommissioning must be performed only by qualified dealer using certified equipment. All prevailing regulations must be followed. ▲

Consider decommissioning the chiller when:

- It fails to maintain desired specifications
- It no longer meets safety standards
- It is beyond repair for its age and worth

Refrigerant and compressor oil must be recovered from equipment before disposal.

**Note** Keep in mind any impact your application may have had on the chiller. ▲

Direct questions about chiller decommissioning or disposal to our Sales, Service and Customer Support.



Handle and dispose in accordance with the manufacturers specification and/or the MSDS for the material used. ▲

## Shipment Storage



Follow the manufacturer's MSDS instructions if decontamination is required. ▲



Transporting and/or storing the chiller in near or below freezing temperatures requires draining, see **Draining** in this Section. Store the chiller in the temperature range of -25°C to 60°C (with packaging), and <80% relative humidity. ▲



If the chiller is stored for more than 90 days it must be flushed with clean fluid before operating. ▲





# Appendix A Country Specific

## 230 VAC, 50 Hz, 1Ø Requirements

Refer to the nameplate label located on the rear of the chiller for specific electrical requirements.

### 1. Chillers shipped to the following locations require a **16 Amp service**:

Afghanistan, Albania, Algeria, Andorra, Angola, Argentina, Armenia, Austria, Azerbaijan, Belarus, Belgium, Benin, Bolivia, Bosnia and Herzegovina, Brazil, Bulgaria, Burkina Faso, Burundi, Cambodia, Cameroon, Cape Verde, Central African Republic, Chad, Chile, Comoros, Congo, Croatia, Czech Republic, Denmark, Djibouti, DR Congo, Ecuador, Egypt, Eritrea, Estonia, Ethiopia, Finland, France, French Guiana, Gabon, Georgia, Germany, Greece, Guinea, Hungary, Iceland, Indonesia, Iran, Iraq, Israel, Italy, Ivory Coast, Jordan, Kazakhstan, Kyrgyzstan, Latvia, Lebanon, Liberia, Libya, Liechtenstein, Lithuania, Luxembourg, Madagascar, Mali, Mauritania, Moldova, Monaco, Mongolia, Morocco, Mozambique, Namibia, Nepal, Netherlands, Niger, North Korea, Norway, Paraguay, Peru, Poland, Portugal, Romania, Russia, Rwanda, Saint Vincent and the Grenadines, San Marino, Sao Tome and Principe, Saudi Arabia, Senegal, Serbia, Slovakia, Slovenia, Somalia, South Africa, South Korea, Spain, Sweden, Switzerland, Syria, Tajikistan, Thailand, Togo, Tunisia, Turkey, Turkmenistan, Ukraine, Uruguay, Uzbekistan, Vanuatu, Vatican City, Vietnam.

---

### 2. Chillers shipped to the following locations require a **15 Amp service**:

Australia, China, Fiji Islands, Nauru, New Zealand, Papua New Guinea, Solomon Island, Tonga, Tuvalu.

---

### 3. Chillers shipped to the following locations require a **13 Amp service**:

Abu Dhabi, Bahrain, Bangladesh, Botswana, Brunei, Cyprus, Dominica, Gambia, Ghana, Gibraltar, Grenada, Hong Kong, India, Ireland, Kenya, Kiribati, Kuwait, Lesotho, Malawi, Malaysia, Maldives, Malta, Mauritius, Myanmar, Nigeria, Oman, Pakistan, Qatar, Saint Lucia, Seychelles, Sierra Leone, Singapore, Sri Lanka, Sudan, Swaziland, Tanzania, Uganda, United Arab Emirates, United Kingdom, Yemen, Zambia, Zimbabwe.

---

# Appendix B Voltage Configuration Instructions

ThermoFlex 900 and 1400 chillers equipped with the 115V 60Hz, 100v 50/60Hz Variable Voltage option and ThermoFlex 900 to 5000 chillers equipped with 200-230V 50/60Hz Global Voltage option have a voltage configuration panel located on the rear of the chiller behind an access panel, see Figure B-1.

- Use a 1/4” socket to remove the four screws securing the access panel to the chiller.
- The configuration panel has two 3-position toggle switches, one for voltage and one for frequency. All chillers are shipped with the toggle switch in the center **SHIP** position. Place each switch to the settings that match the voltage/frequency supplied to the chiller.

**Note** For ThermoFlex900-2500 global voltage chillers, the compressor and fan will not operate when the switch is in the **SHIP** position. ▲

- Reinstall the access panel.

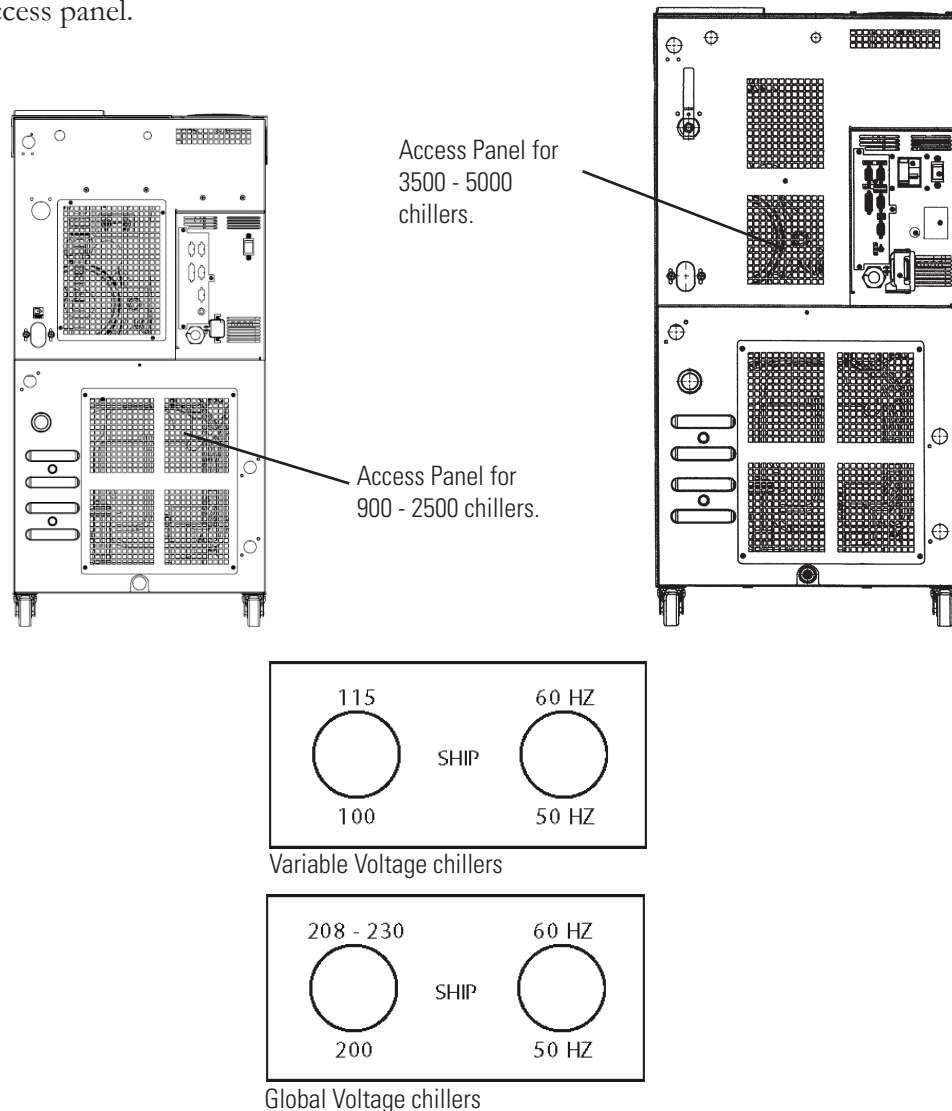

**Figure B-1** Variable/Global Voltage Chillers

# Appendix C Analog I/O and Remote Sensor

## Analog I/O Connector Pinout ♀

Install your analog input/output device to the 15-pin female connector on the rear of the chiller. Analog I/O is activated using the Setup Loop, see page C-3.

PIN	NAME	NOTES	DEFINITION
1	DIGITAL GROUND		Common round connection for pins 12, 13 and 14
2	Not Used		
3	LOW LEVEL (Only if option chosen)	Note 1	<u>Dry Relay Contact</u> : Reference to pin 11. Closes if either level switch is in the "low" position for more than 1 second.
4	CONFIGURABLE RELAY 2	Note 1	<u>Dry Relay Contact</u> : Reference to pin 11. Closes when any configured fault or warning occurs, see Table 2.
5	PUMP ON	Note 1	<u>Dry Relay Contact</u> : Reference to pin 11. Closes when pump is turned on. Opens when pump is turned off.
6	ANALOG GROUND		Common for analog signals (pins 2, 7 and 15)
7	RESERVOIR TEMP OUT <b>OR</b> EXTERNAL SENSOR TEMPERATURE IF EXTERNAL SENSOR ENABLED	Note 2	Analog Voltage Output 0-10VDC, 10mV/°C, or 4-20mA: Reference to pin 6. This voltage output is proportional to the reservoir fluid temperature: Default scale= 0–10V (where: 0V = Low Temp Span, 10V = Hi Temp Span) Optional Range = 10mV/ °C. (Ex: 200mV = 20°C) (Max Load @ 10V = 5mA) or 4-20mA, 4mA = low temp span, 20 mA = high temp span (maximum output current = 5mA @10VDC.
8	LOW FLOW (Only if option chosen)	Note 1	<u>Dry Relay Contact</u> : Reference to pin 11. Closes when a low flow occurs while the pump is on. Note: To allow the pump to get up to speed at startup, the pump runs for 3 - 5 seconds before the low flow sensor is read.
9	CONFIGURABLE RELAY 1 (Normally Open)	Note 1	<u>Dry Relay Contact</u> : Reference to pin 11. Closes when any of the configured faults occur, see Table 1.
10	CONFIGURABLE RELAY 1 (Normally Closed)	Note 1	<u>Dry Relay Contact</u> : Reference to pin 11. Complement of pin 9 (open when pin 9 is closed).
11	RELAY COMMON		Common for all relay contacts (pins 3, 4, 5, 8, 9, 10).
12	REMOTE START ENABLE	Note 3	Connect to pin 1 to allow chiller to be remotely turned on/off through pin 14 REMOTE START.

Note 1: All relay contacts (except for Pin 10) are normally OPEN when power is off. Pin 10 contacts are normally CLOSED when power is off. Relay contacts are rated: 24V AC/DC, 2A, <= 0.08 Ohm maximum each or 5A total for all relays combined, 1mA minimum, switching capacity: 48VA/48W (Resistive load only).

Note 2: Default = 0-10VDC

Note 3: Connect to digital ground (pin 1) using a low resistance connection (gold contact relay).

PIN	NAME	NOTES	DEFINITION
13	REMOTE SETPOINT ENABLE	Note 3	Connect to pin 1 to allow the setpoint to be changed remotely through pin 15 REMOTE SETPOINT.
14	REMOTE START	Note 3	Connect to pin 1 to turn chiller on. Disconnect to turn chiller off. Note: Pins 1 and 12 must be connected to allow operation from this pin.
15	REMOTE SETPOINT	Note 2, 4	Analog Voltage Input 0-10VDC, 10mV/°C, or 4-20mA: Reference to pin 6. Apply a DC voltage to this pin to adjust the chiller's setpoint: Default Range = 0 – 10V (where: 0V = Low Temp Span, 10V = Hi Temp Span) (Input Impedance > 600K) Optional Range = 10mV/ °C. (Ex: 200mV = 20°C) (Max Input Voltage = 10VDC, or 4-20mA, 4mA = low temp span, 20 mA = high temp span.

Note 1: All relay contacts (except for Pin 10) are normally OPEN when power is off. Pin 10 contacts are normally CLOSED when power is off. Relay contacts are rated: 24V AC/DC, 2A, <= 0.08 Ohm maximum each or 5A total for all relays combined, 1mA minimum, switching capacity: 48VA/48W (Resistive load only).

Note 2: Default = 0-10VDC

Note 3: Connect to digital ground (pin 1) using a low resistance connection (gold contact relay).

Note 4: Remote setpoint must be enabled, pin 13

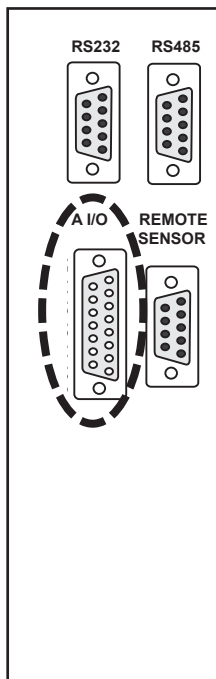

**WARNING** Never apply line voltage to any of the connections. ▲

When making your connection to the ThermoFlex Analog I/O connector, in order to comply with the EMC directive:

- Use a shielded I/O cable
- Connect the remote end of the cable shield to earth ground.
- Connect cable shield to ThermoFlex end connector.

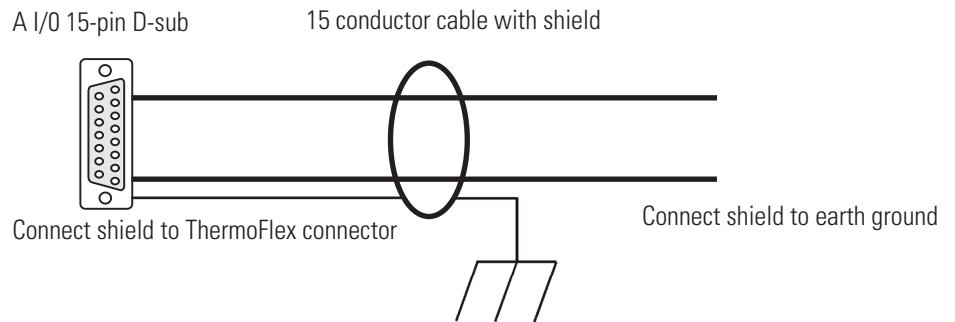

**Figure C-1** Analog I/O Connector

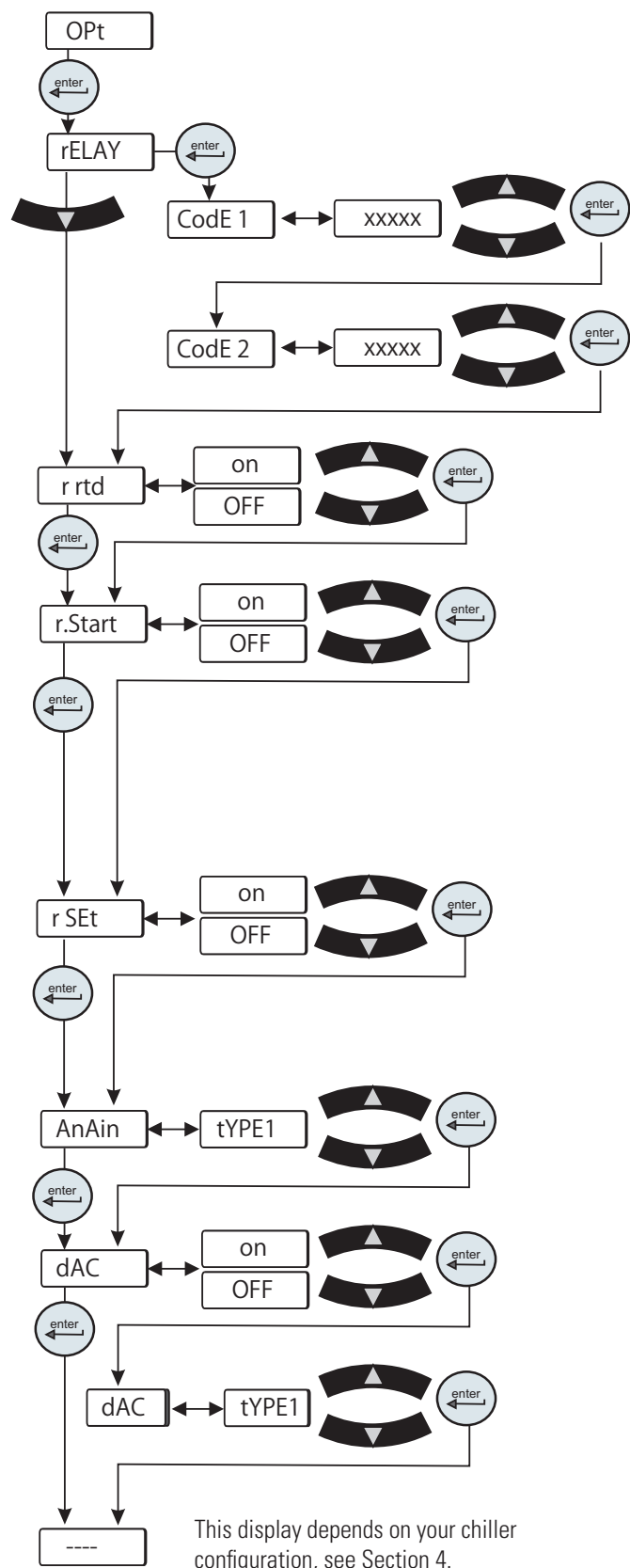

**Figure C-2** Analog I/O Loop

• **rELAY** is used to configure relay 1 (**Code 1**) and relay 2 (**Code 2**), see Tables 1 and 2 on the next page.

For example: To have just the drip pan, 4, **and** low temp, 8, error faults enabled for relay 1 you would enter their sum, 12, at the **Code 1** display. To have the tank overflow, 2, the low temp, 16, **and** high pressure, 1024, error faults enabled for relay 2 you would enter their sum, 1040, at the **Code 2** display.

• **r rtd** is used to enable/disable the remote temperature sensor. See Table 3 for pin out information.

**Note** There is no other indication on the chiller that the remote sensor is enabled. ▲

• **r.Start** is used to enable/disable the remote start/stop.

**Note** Enabling analog I/O remote start/stop disables the chiller's local controller start/stop capability. Enabling analog I/O remote also overrides serial communications start/stop commands. ▲

• **r SEt** is used to enable/disable the remote setpoint.

**Note** When remote setpoint is enabled a flashing dot will appear on the controller's display as shown below. ▲



• **AnAin** is used to configure the analog voltage input type.

**Type 1:** 0 - 10 VDC (Default)

**Type 2:** 10 mV/°C

**Type 3:** 4 - 20 mA

• **dAC** is used to enable/disable the digital to analog converter. Once enabled, the desired output type can be selected.

**Note** The **Type** display only appears if **dAC** is set to **on**. ▲

**Type 1:** 0 - 10 VDC (Default)

**Type 2:** 10 mV/°C

**Type 3:** 4 - 20 mA

**Table 1 Configurable Relay #1 (CodE1)**

Error	Error Code	Factory Default	
Low Level (option)	LLF	Enable	1 (Default)
Tank Overflow	o FLo	Disable	2
Drip Pan Full (option)	driP	Disable	4
Low Temp	Lo t*	Disable	8
High Temp	Hi t*	Disable	16
Low Flow (option)	LoFLo*	Enable	32 (Default)
High Flow (option)	HiFLo*	Disable	64
Low Resistivity (option)	Er 28*	Disable	128
High Resistivity (option)	Er 30*	Disable	256
High Pressure	Hi P1*	Disable	512
Low Pressure	Lo P1*	Disable	1024
Chiller Fault	Any Fault	Enable	2048 (Default)
Pump/Chiller Shut Off	Status bit(s)	Disable	4096
Refrigeration Shut Off	Status Bit	Disable	8192
Limit Fault (option)	PHEr, oL, LPC, HPC, Er 47, Er 48	Enable	16384 (Default)
Sensor Fault	Er 23, Er 24, Er 25, Er 26 external sensor opened or shorted	Disable	32768
			Default Relay Code 1 Display = 18465 (1 + 32 + 2048 + 16384 = 18465)

\*Regardless of alarm setting - fault or indicator

**Table 2 Configurable Relay #2 (CodE2)**

Error	Error Code	Factory Default	
Low Level (option)	Add	Disable	1
Tank Overflow	o FLo	Disable	2
Drip Pan Full (option)	driP	Disable	4
Auto Refill Error (option)	rEFiL	Disable	8
Low Temp	Lo t*	Enable	16 (Default)
High Temp	Hi t*	Enable	32 (Default)
Low Flow (option)	Lo FL*	Disable	64
High Flow (option)	Hi FL*	Disable	128
Low Resistivity (option)	Er 28*	Disable	256
High Resistivity (option)	Er 30*	Enable	512 (Default)
High Pressure	Hi P1*	Disable	1024
Low Pressure	Lo P1*	Disable	2048
Indicator (warning)	Any Indicator	Disable	4096
PM Timer (option)	di, SEr 1 to 6	Disable	8192
Communication Error	Er 15, Er 41, Er 42	Disable	16384
Sensor Fault	Er 23, Er 24, Er 25, Er 26 external sensor opened or shorted	Enable	32768 (Default)
			Default Relay Code 2 Display = 33328 (16 + 32 + 512 + 32768 = 33328)

\*Regardless of alarm setting - fault or indicator



## Analog Input Calibration

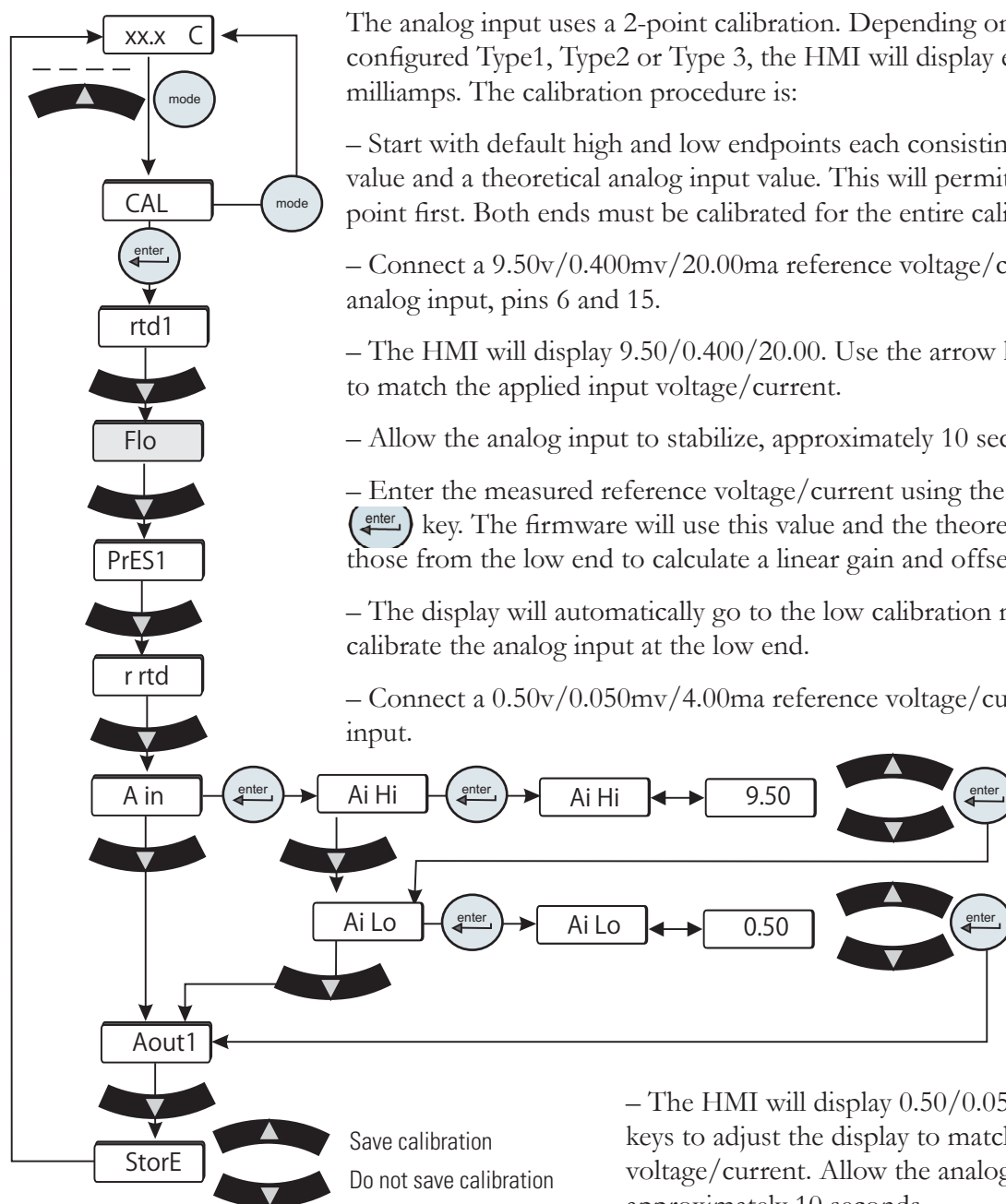

**Figure C-3** Analog Input Calibration Loop

The analog input uses a 2-point calibration. Depending on how the analog input is configured Type1, Type2 or Type 3, the HMI will display either volts, millivolts or milliamps. The calibration procedure is:

- Start with default high and low endpoints each consisting of a voltage/current value and a theoretical analog input value. This will permit calibration of either point first. Both ends must be calibrated for the entire calibration to be valid.
- Connect a 9.50v/0.400mv/20.00ma reference voltage/current source to the analog input, pins 6 and 15.
- The HMI will display 9.50/0.400/20.00. Use the arrow keys to adjust the display to match the applied input voltage/current.
- Allow the analog input to stabilize, approximately 10 seconds.
- Enter the measured reference voltage/current using the HMI by pressing the (enter) key. The firmware will use this value and the theoretical analog value and those from the low end to calculate a linear gain and offset.
- The display will automatically go to the low calibration message. Press (enter) to calibrate the analog input at the low end.
- Connect a 0.50v/0.050mv/4.00ma reference voltage/current source to the analog input.

- The HMI will display 0.50/0.050/4.00. Use the arrow keys to adjust the display to match the applied input voltage/current. Allow the analog input to stabilize, approximately 10 seconds.

- Enter the measured reference voltage/current using the HMI by pressing the (enter) key. The firmware will use this value and the theoretical analog input value and those from the high end to calculate a linear gain and offset.

- If the gain and offset are acceptable, the calibration is accepted and the calibration is now valid at the low end. Otherwise, the calibration is rejected and a bad calibration error message (**Er 16**) is displayed.

## Analog Output Calibration

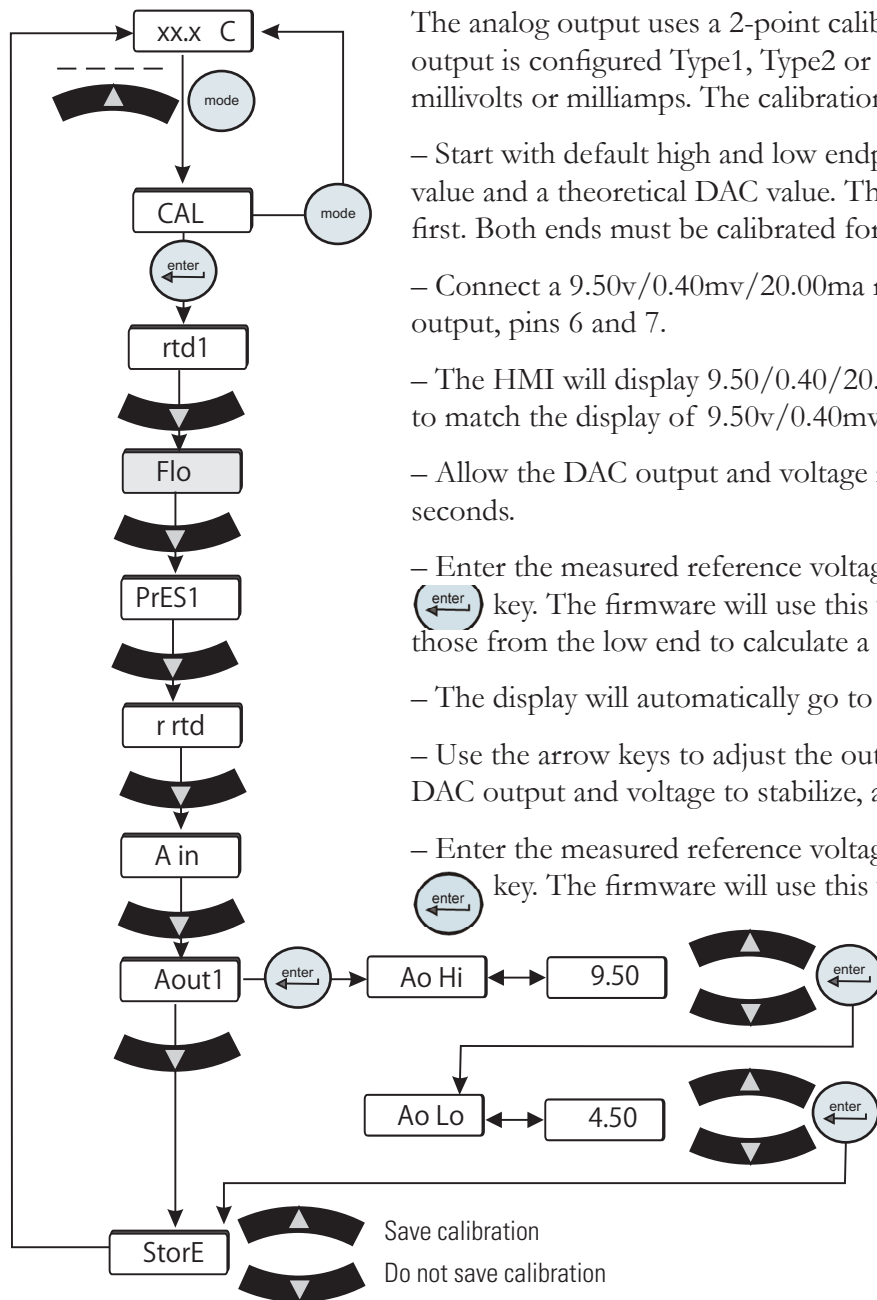

The analog output uses a 2-point calibration. Depending on how the analog output is configured Type1, Type2 or Type 3, the HMI will display either volts, millivolts or milliamps. The calibration procedure is:

- Start with default high and low endpoints each consisting of a voltage/current value and a theoretical DAC value. This will permit calibration of either point first. Both ends must be calibrated for the entire calibration to be valid.

- Connect a 9.50v/0.40mv/20.00ma reference voltage/current meter to the DAC output, pins 6 and 7.

- The HMI will display 9.50/0.40/20.00. Use the arrow keys to adjust the output to match the display of 9.50v/0.40mv/20.00ma.

- Allow the DAC output and voltage reading to stabilize, approximately 10 seconds.

- Enter the measured reference voltage/current using the HMI by pressing the  key. The firmware will use this value and the theoretical DAC value and those from the low end to calculate a linear gain and offset.

- The display will automatically go to the low calibration point.

- Use the arrow keys to adjust the output to match the displayed value. Allow the DAC output and voltage to stabilize, approximately 10 seconds .

- Enter the measured reference voltage/current using the HMI by pressing the  key. The firmware will use this value and the theoretical DAC value and

those from the high end to calculate a linear gain and offset.

- If the gain and offset are acceptable, the calibration is accepted and the calibration is now valid at the low end. Otherwise, the calibration is rejected and a bad calibration error message (**Er 16**) is displayed.

**Figure C-4** Analog Output Calibration Loop

# Remote Sensor Connector Pinout

**Table 3**

Pin	
1	White
2	NA
3	NA
4	White
5	NA
6	NA
7	Red
8	NA
9	Red (4th wire not connected to the control board)

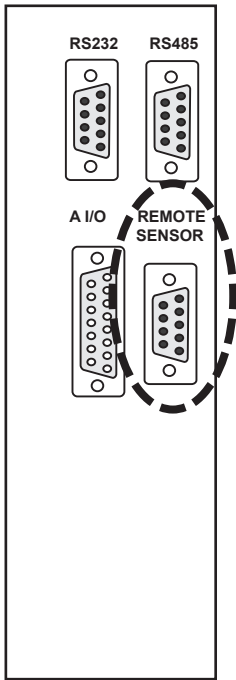
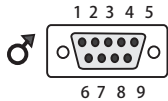

Never apply line voltage to any of the connections. ▲



When operating a ThermoFlex7500-10000 with the remote sensor enabled ensure the chiller's response to lowering the setpoint does not result in operation below 10°C process temperature. Operation below 10°C requires the use of 50/50 EG/water or 50/50 PG/water. ▲

**Figure C-5** Remote Sensor Connector

## Remote Sensor Calibration

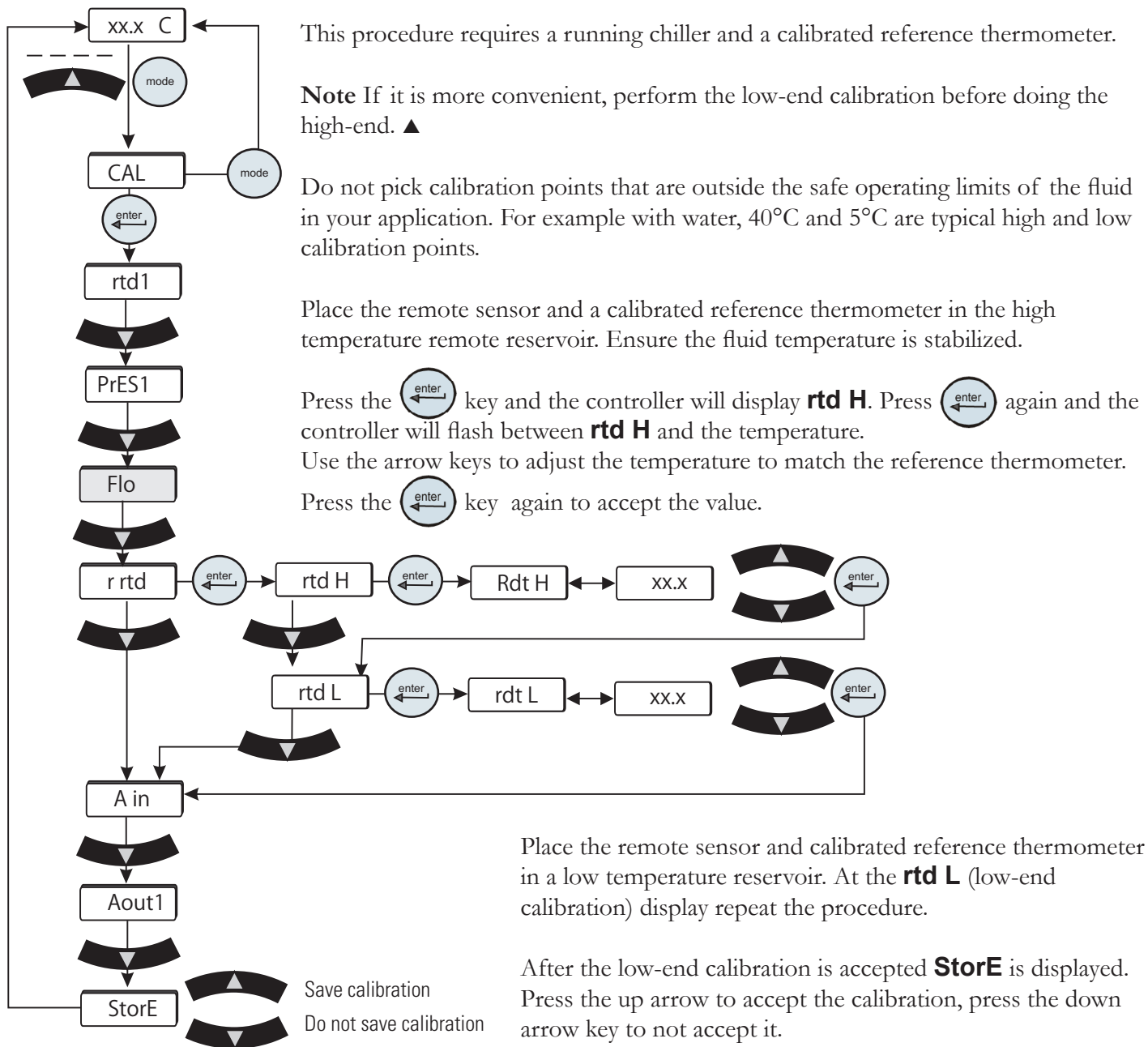

**Figure C-6** Remote Sensor Calibration Loop

**Note** After pressing the up arrow button at the **StorE** prompt wait several seconds before proceeding to ensure that a bad calibration message (**Er 16**) does not appear. Premature use of the keypad after pressing the up arrow may cancel the bad calibration error message. ▲

# Appendix D NC Serial Communications Protocol

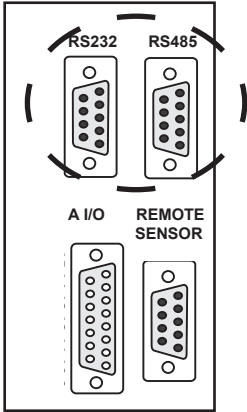

**Note** Appendix D assumes you have a basic understanding of communications protocols. ▲



**WARNING** Never apply line voltage to any of the connections. ▲

Connect your PC to the applicable connector on the rear of the chiller. Use the Setup Loop, see Section 4, to enable serial communications.

**Note** Keypad operation is still available with serial communications enabled. ▲

**Figure D-1** Connectors

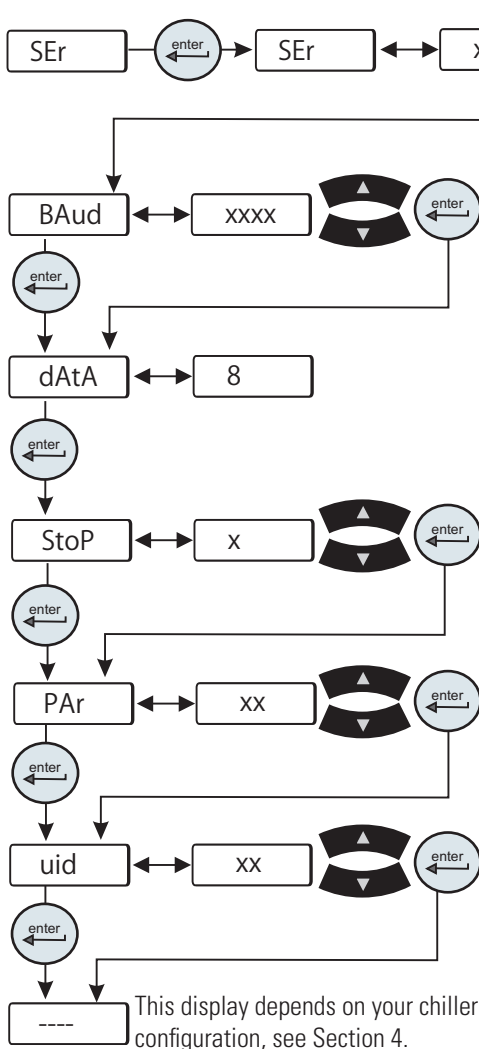

• **SEr** is used to enable/disable and to configure serial communications.

**Range:** oFF, rS232, rS485

**Default:** oFF

• **BAud** is used to select the baud rate (speed) for serial communications.

**Range:** 9600, 4800, 2400, 1200, 600, or 300 bits per second

**Default:** 9600

• **dAtA** is used to display the number of data bits.

**Range:** Fixed at 8

• **StoP** is used to indicate the number of stop bits.

**Range:** 2 or 1

**Default:** 1

• **PAr** is used as a means to check for communication errors.

**Range:** even, odd, or none

**Default:** none

• **uid** (chiller id) is used in RS485 only. Identifies devices connected to the RS 485 port.

**Range:** 1 to 99

**Default:** 1

**Note:** To prevent data errors limit the number of chillers to 32. ▲

**Figure D-2** Serial Communications Loop

All data is sent and received in binary form, do not use ASCII. In the following pages the binary data is represented in hexadecimal (hex) format.

The NC Serial Communications Protocol is based on a master-slave model. The master is a host computer, while the slave is the chiller's controller. Only the master can initiate a communications transaction (half-duplex). The slave ends the transaction by responding to the master's query. The protocol uses RS-232/RS-485 serial interface with the default parameters: 9600 baud, 8 data bits, 1 stop bit, and no parity. RS-485 offers a slave address selection, default parameter: 1.

The chiller can be controlled through your computer's serial port by using the chiller's standard female 9-pin connection.

**RS-232 COMM**

Pin #	Function
1	No connection
2	TX
3	RX
4	No connection
5	GND = Signal ground
6 - 9	No connection

TX = Transmitted data from controller  
 RX = Received data to controller.

**RS-485 COMM**

Pin #	Function
1-7	No connection
8	T+
9	T-

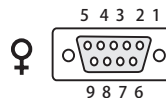

**Hardware Mating Connector**  
**AMP Part# 745492-2 or equivalent**

Communication cables are available from Thermo Fisher. Contact us for additional information.

All commands must be entered in the exact format shown in the tables on the following pages. The tables show all commands available, their format and responses. Controller responses are either the requested data or an error message. The controller response *must* be received before the host sends the next command.

The host sends a command embedded in a single communications packet, then waits for the controller's response. If the command is not understood or the checksums do not agree, the controller responds with an error command. Otherwise, the controller responds with the requested data. If the controller fails to respond within 1 second, the host should resend the command.

**Note** All byte values are shown in hex, hex represents the binary values that must be sent to the chiller. **Do not use ASCII.** ▲

The framing of the communications packet in both directions is:

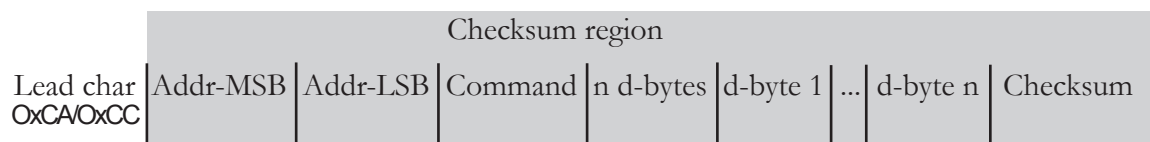

<i>Lead char</i>	<b>0xCA (RS-232) 0xCC (RS-485)</b>
<i>Addr-msb</i>	Device address is 1 (RS-232)
<i>Addr-lsb</i>	Most significant byte of slave address (RS-232: 0)
<i>Command</i>	Least significant byte of slave address (RS-232: 1)
<i>n d-bytes</i>	Command byte (see Table of Commands)
<i>d-byte 1</i>	Number of data bytes to follow
<i>...</i>	1 <sup>st</sup> data byte (the qualifier byte is considered a data byte)
<i>d-byte n</i>	...
<i>Checksum</i>	n <sup>th</sup> data byte.
	Bitwise inversion of the 1 byte sum of bytes beginning with the most significant address byte and ending with the byte preceding the checksum. (To perform a bitwise inversion, "exclusive OR" the one byte sum with FF hex.)

When a command has no value associated with it (e.g., REQ ACK), “n d-bytes” will be set to 0. Values such as temperature and flow are sent as either 2 or 4 byte signed integers, depending on how they are stored in the controller RAM.

When the controller sends a value, a qualifier byte is sent first, followed by a 2 or 4 byte integer (the least significant byte is sent last). The qualifier indicates the precision and units of the value. The host does not send the qualifier byte; it must send the value using the correct precision, units and number of bytes. The host first inquires about a value it wants to change, then uses the number of data bytes and the qualifier byte it receives to generate the proper integer to send.

**Analog Values**

Qualifier Byte	
b.7	Precision of measurement
b.6	
b.5	
b.4	
b.3	Unit of measure index
b.2	
b.1	
b.0	

Unit of Measure	
Index	Unit
0	NONE
1	Temperature in °C
2	Temperature in °F
3	Flow liters per minute
4	Flow in gallons per minute
5	Time in seconds
6	Pressure in PSI
7	Pressure in bars
8	Resistivity in MΩ-cm
9	%
10	Volts
11	Pressure in kPa

A qualifier byte of 0x12 indicated that the value contains one decimal point and the units are °F, e.g., 98.6°F.

Example to set setpoint to 25°C:

If the temperature units are unknown, before changing the setpoint send a command to request setpoint. The response will include both the precision and units. Precision is fixed at 0.1 and units can be either °C or °F. If the units are already known skip to step 3.

1. Master sends: CA 00 01 70 00 8E (REQ SETPOINT1)
2. Slave responds: CA 00 01 70 03 11 00 C8 B2 Precision =0.1, units =°C, value=200  
(200 x 0.1°C=20.0°C)

Response indicates:

uses a 2 byte integer (nn=03)

precision and units are 0.1°C (d1=11)

3. Master sends: CA 00 01 F0 02 00 FA 12 (Set Setpoint 1 to 25.0°C)
4. Slave responds: CA 00 01 F0 03 11 00 FA 00 Precision =0.1, units =°C, value=250  
(250 x 0.1°=25.0.0°C)

See Additional Command Examples in this Appendix.



## Table of Commands

Command	M: Master Sends S: Slave Responds	Notes
Request Status		
REQ ACK	M: lc a1 a2 <b>00</b> 00 cs S: lc a1 a2 <b>00</b> 02 v1 v2 cs	protocol version v1=0; v2=1
REQ CONTROLLER SW VER or FIRMWARE CHECKSUM	M: lc a1 a2 <b>02</b> 00 cs S: lc a1 a2 <b>02</b> nn d1 ... dn cs	Controller SW version in ASCII
Example: Request SW version, controller returns 084992.2N		
1. Master sends:	lc a1 a2 <b>02</b> 00 cs	
2. Slave responds:	lc a1 a2 <b>02</b> 0A 30 38 34 39 39 32 2E 32 4E 20 E4	
Example: Request controller checksum, controller returns 20FA		
1. Master sends:	CA 00 01 <b>02</b> 01 01 FA	
2. Slave responds:	CA 00 01 <b>02</b> 04 32 30 46 41 0F	
REQ DISPLAY MSG	M: lc a1 a2 <b>07</b> 00 cs S: lc a1 a2 <b>07</b> nn d1 ... dn cs	Display message in ASCII
REQ STATUS	M: lc a1 a2 <b>09</b> 00 cs S: lc a1 a2 <b>09</b> nn d1 ... dn cs	see Request Status Table in this Appendix
ERROR	M: S: lc a1 a2 <b>0F</b> 02 en ed cs	Response Only! ed = Error Data en = Error Number 1: Bad Command 2: Bad Data 3: Bad Checksum See Error in this Appendix

## REQUEST LOW ALARM VALUES

REQ LO FLOW1	M: lc a1 a2 <b>30</b> 00 cs S: lc a1 a2 <b>30</b> 03 d1 d2 d3 cs	Process Alarm
REQ LO TEMP1	M: lc a1 a2 <b>40</b> 00 cs S: lc a1 a2 <b>40</b> 03 d1 d2 d3 cs	Process Alarm
REQ LO ANALOG1	M: lc a1 a2 <b>48</b> 00 cs S: lc a1 a2 <b>48</b> 03 d1 d2 d3 cs	Pressure Process Supply Alarm

## REQUEST HIGH ALARM VALUES

REQ HI FLOW1	M: lc a1 a2 <b>50</b> 00 cs S: lc a1 a2 <b>50</b> 03 d1 d2 d3 cs	Process Alarm
REQ HI TEMP1	M: lc a1 a2 <b>60</b> 00 cs S: lc a1 a2 <b>60</b> 03 d1 d2 d3 cs	Process Alarm
REQ HI ANALOG1	M: lc a1 a2 <b>68</b> 00 cs S: lc a1 a2 <b>68</b> 03 d1 d2 d3 cs	Pressure Process Supply Alarm

## REQUEST MEASUREMENTS

REQ FLOW1	M: lc a1 a2 <b>10</b> 00 cs S: lc a1 a2 <b>10</b> 03 d1 d2 d3 cs	Process Fluid Flow
REQ TEMP1	M: lc a1 a2 <b>20</b> 00 cs S: lc a1 a2 <b>20</b> 03 d1 d2 d3 cs	Process Fluid Supply Temperature (RTD1)
REQ TEMP4	M: lc a1 a2 <b>23</b> 00 cs S: lc a1 a2 <b>23</b> 03 d1 d2 d3 cs	Remote Temperature (RTD4)
REQ ANALOG1	M: lc a1 a2 <b>28</b> 00 cs S: lc a1 a2 <b>28</b> 03 d1 d2 d3 cs	Process Fluid Supply Pressure (P1)
REQ ANALOG2	M: lc a1 a2 <b>29</b> 00 cs S: lc a1 a2 <b>29</b> 03 d1 d2 d3 cs	Refrigeration Suction Pressure (P2)

## REQUEST PID SETTINGS

REQ SETPT1	M: lc a1 a2 <b>70</b> 00 cs S: lc a1 a2 <b>70</b> 03 d1 d2 d3 cs	Process Fluid Setpoint
REQ COOL P TERM1	M: lc a1 a2 <b>74</b> 00 cs S: lc a1 a2 <b>74</b> 03 d1 d2 d3 cs	
REQ COOL I TERM1	M: lc a1 a2 <b>75</b> 00 cs S: lc a1 a2 <b>75</b> 03 d1 d2 d3 cs	
REQ COOL D TERM1	M: lc a1 a2 <b>76</b> 00 cs S: lc a1 a2 <b>76</b> 03 d1 d2 d3 cs	

## SET STATUS SETTINGS

SET KEYSTROKE	M: lc a1 a2 <b>80</b> 01 d1 cs S: lc a1 a2 <b>80</b> 01 d1 cs	See Keystroke in this Appendix
SET ON/OFF ARRAY	M: lc a1 a2 <b>81</b> nn d1 ... dn cs S: lc a1 a2 <b>81</b> nn d1 ... dn cs	See Set On/Off Array in this Appendix d1: 0 = OFF, 1 = ON, 2 = no change
SET LOW ALARM VALUES		
SET LO FLOW1	M: lc a1 a2 <b>B0</b> 02 d1 d2 cs S: lc a1 a2 <b>B0</b> 03 d1 d2 d3 cs	Process Alarm
SET LO TEMP1	M: lc a1 a2 <b>C0</b> 02 d1 d2 cs S: lc a1 a2 <b>C0</b> 03 d1 d2 d3 cs	Process Alarm
SET LO ANALOG1	M: lc a1 a2 <b>C8</b> 02 d1 d2 cs S: lc a1 a2 <b>C8</b> 03 d1 d2 d3 cs	Pressure Process Supply Alarm
SET HIGH ALARM VALUES		
SET HI FLOW1	M: lc a1 a2 <b>D0</b> 02 d1 d2 cs S: lc a1 a2 <b>D0</b> 03 d1 d2 d3 cs	Process Alarm
SET HI TEMP1	M: lc a1 a2 <b>E0</b> 02 d1 d2 cs S: lc a1 a2 <b>E0</b> 03 d1 d2 d3 cs	Process Alarm
SET HI ANALOG1	M: lc a1 a2 <b>E8</b> 02 d1 d2 cs S: lc a1 a2 <b>E8</b> 03 d1 d2 d3 cs	Pressure Process Supply Alarm
SET PID Settings		
SET SETPT1	M: lc a1 a2 <b>F0</b> 02 d1 d2 cs S: lc a1 a2 <b>F0</b> 03 d1 d2 d3 cs	Process Fluid Setpoint
SET COOL P TERM1	M: lc a1 a2 <b>F4</b> 02 d1 d2 cs S: lc a1 a2 <b>F4</b> 03 d1 d2 d3 cs	Cool P Term
SET COOL I TERM1	M: lc a1 a2 <b>F5</b> 02 d1 d2 cs S: lc a1 a2 <b>F5</b> 03 d1 d2 d3 cs	Cool I Term
SET COOL D TERM1	M: lc a1 a2 <b>F6</b> 02 d1 d2 cs S: lc a1 a2 <b>F6</b> 03 d1 d2 d3 cs	Cool D Term

## Request Status Table

### Basic

nn	4				
	b0	Chiller Running		b0	External EMO fault
	b1	RTD1 open or shorted		b1	Local EMO fault
	b2	RTD2 open or shorted		b2	Low Flow fault
d1	b3	RTD3 open or shorted	d3	b3	Auto Refill fault/ Low Level fault
	b4	High Temp fixed fault		b4	Sense 5V fault
	b5	Low Temp fixed fault		b5	Invalid level fault
	b6	High Temp fault or warn		b6	Low fixed flow warn
	b7	Low Temp fault or warn		b7	High pressure fault (set at factory)
	b0	High Pressure fault or warn		b0	Low pressure fault (set at factory)
	b1	Low Pressure fault or warn	d4	b1	Chiller powering up
	b2	Drip Pan fault		b2	Chiller powering down
d2	b3	High Level fault			
	b4	Phase Monitor fault			
	b5	Motor Overload fault			
	b6	LPC fault			
	b7	HPC fault			

## Error

The slave detected an error in the message it received from the master, so it returns this command instead of echoing the command sent by the master. The slave returns the command it received from the master in the ed byte, and an error code in the en byte.

en	Error
1	Bad command – not recognized by slave
2	Bad data
3	Bad checksum

Some errors may not result in any response. The slave ignores incoming bytes until it sees the valid lead character and its slave address. Then it must receive the correct number of bytes (determined by the length byte) before it can respond. If an incomplete frame is received, the slave will time out and clear its input buffer without responding.

## Set On/Off Array

This command is used to set the state of the chiller, on or off. Sending a 0 in the array turns off the chiller while sending a 1 turns it on. Sending a 2 does not change the state. The array is returned showing the state after the command has been carried out. Sending all 2's effectively turns this command into a request status command.

nn	1
d1	Chiller On/Off

## Set Keystroke

This command is used to affect a keystroke remotely as if someone pressed the key on the HMI.

Value	
0	Null
1	Enter
2	Up/Yes
3	Down/No
4	Mode
5	On/Off

### Set Special Commands

These commands are product specific.

Master Sends: lc a1 a2 **8D** nn d1 d2 d3 d4 d5 d6 cs

Slave Returns: lc a1 a2 **8D** nn d1 d2 d3 d4 d5 d6 cs

Byte	Master	Slave
d1	Command byte	
d2	Entered Value MSB	
d3	Entered Value	
d4	Entered Value	
d5	Entered Value	
d6	Entered Value LSB	

Command	Master sends	Description	Slave returns
0x00	CA 00 01 8D 02 d1 d2 cs d1 = command byte = 00 d2 = analog option byte	Set analog option	CA 00 01 8D 03 00 d2 d3 cs
0x80	CA 00 01 8D 01 80 cs	Request PM status	CA 00 01 8D 03 80 d2 d3 cs

### Set analog option command

d2 analog option byte

b.6 - b.7 = unused	b.4 - b.5 = DAC enable	b.2 - b.3 = DAC out	b.0 - b.1 = analog in
	0 = voltage	0 = voltage	0 = voltage
	1 = millivolt	1 = millivolt	1 = millivolt
	2 = current	2 = current	2 = current
	3 = no change	3 = no change	3 = no change

Eg. Command to enable DAC, set DAC out to Voltage and set Analog in to millivolt

Master sends

CA 00 01 8D 02 00 11 5E

Slave returns

CA 00 01 8D 02 00 11 5E

Eg. Command to set DAC out to current without changing DAC enable or analog in

Master sends

CA 00 01 8D 02 00 3B 34

Slave returns

CA 00 01 8D 02 00 19 56

## DECLARATION OF CONFORMITY

Manufacturer: Thermo Fisher Scientific  
Address: 25 Nimble Hill Road  
Newington, NH 03801 USA



Products: Refrigerated chillers and heat exchangers.

Year of inception 2013

We declare that the following products conform to the Directives and Standards listed below:

Unit has a 16 digit part number consisting of UU TVPC XXXXXXXX defined as follows:

UU = Unit type can be:

10 = TF 900    11 = TF 1,400    12 = TF 2,500    13 = TF 3,500    14 = TF 5,000  
15 = TF 7,500    16 = TF 10,000    17 = TF 15,000    18 = TF 20,000    19 = TF 24,000

T = Type of unit cooling and Temperature Range can be 1-4 inclusive, where:

1 = Air Cooled Standard Temp (5-40°C)    2 = Air Cooled Hi Temp (5-90°C)  
3 = Water Cooled Standard Temp (5-40°C)    4 = Water Cooled Hi Temp (5-90°C)

V = Unit voltage rating:

1 = 115V, 60Hz	1Ph	17 = 200/208/230V, 60Hz	3Ph	17 = 208/230V, 60Hz	3Ph
100V, 50Hz	1Ph	200V, 50Hz	3Ph		
2 = 100/115V, 60Hz	1Ph	18 = 400V, 50Hz	3Ph	18 = 400V, 50Hz	3Ph
100/115V, 50Hz	1Ph	20 = 200/208/230V, 60Hz	3Ph		
3 = 208/230V, 60Hz	1Ph	200-230V, 50Hz	3Ph		
200V, 50Hz	1Ph	21 = 460V, 60Hz	3Ph	21 = 460V, 60Hz	3Ph
4 = 230V, 50Hz	1Ph	400V, 50Hz	3Ph	400V, 50Hz	3Ph
7 = 200/208/230V, 60Hz	1Ph				
200/230V, 50Hz	1Ph				

P = Pump type, can be 0 through 9 inclusive or B, C or F.

C = Unit controller type, can be any digit 1-6, inclusive.

X = Any digit 0-9 inclusive, used as sequential numbering only.

Equipment Class: Measurement, control and laboratory

Directives and Standards:

2004/108/EC – Electromagnetic Compatibility (EMCD):

EN 61326-1: 2006 – Electrical equipment for measurement, control, and laboratory use – EMC requirements, EMC Class A

2006/95/EC – Low Voltage Directive (LVD):

EN/IEC 61010-1: 2010 – Safety Requirements For Electrical Equipment For Measurement, Control, And Laboratory Use: General Requirements.

EN 61010-1: 2001 – Safety Requirements For Electrical Equipment For Measurement, Control, And Laboratory Use: General Requirements.

EN 61010-2-010: 2003 – Safety Requirements For Electrical Equipment For Measurement, Control, And Laboratory Use – Part 2-010: Particular Requirements For Laboratory Equipment For The Heating Of Materials.

Additional EMC Evaluations with Certificates:

EN 61000-3-2: 2006 Harmonics

EN 61000-3-3: 2008 Flicker

Manufacturer's Authorized Representative:

Date:

20 Sept. 2013

Robin Wiley Compliance Engineering

## WARRANTY

Thermo Fisher Scientific warrants for 24 months (**excluding MD1/MD2 Magnetic Drive and P1/P2 Positive Displacement pumps which are warranted for 12 months**) from date of shipment the Thermo Scientific ThermoFlex chiller according to the following terms.

Any part of the chiller manufactured or supplied by Thermo Fisher Scientific and found in the reasonable judgment of Thermo Fisher to be defective in material or workmanship will be repaired at an authorized Thermo Fisher Repair Depot without charge for parts or labor. The chiller, including any defective part must be returned to an authorized Thermo Fisher Repair Depot within the warranty period. The expense of returning the chiller to the authorized Thermo Fisher Repair Depot for warranty service will be paid for by the buyer. Our responsibility in respect to warranty claims is limited to performing the required repairs or replacements, and no claim of breach of warranty shall be cause for cancellation or rescission of the contract of sales of any chiller. With respect to chillers that qualify for field service repairs, Thermo Fisher Scientific's responsibility is limited to the component parts necessary for the repair and the labor that is required on site to perform the repair. Any travel labor or mileage charges are the financial responsibility of the buyer.

The buyer shall be responsible for any evaluation or warranty service call (including labor charges) if no defects are found with the Thermo Scientific product.

This warranty does not cover any chiller that has been subject to misuse, neglect, or accident. This warranty does not apply to any damage to the chiller that is the result of improper installation or maintenance, or to any chiller that has been operated or maintained in any way contrary to the operating or maintenance instructions specified in this Instruction and Operation Manual. This warranty does not cover any chiller that has been altered or modified so as to change its intended use.

In addition, this warranty does not extend to repairs made by the use of parts, accessories, or fluids which are either incompatible with the chiller or adversely affect its operation, performance, or durability.

Thermo Fisher Scientific reserves the right to change or improve the design of any chiller without assuming any obligation to modify any chiller previously manufactured.

THE FOREGOING EXPRESS WARRANTY IS IN LIEU OF ALL OTHER WARRANTIES, EXPRESSED OR IMPLIED, INCLUDING BUT NOT LIMITED TO WARRANTIES OR MERCHANTABILITY AND FITNESS FOR A PARTICULAR PURPOSE.

OUR OBLIGATION UNDER THIS WARRANTY IS STRICTLY AND EXCLUSIVELY LIMITED TO THE REPAIR OR REPLACEMENT OF DEFECTIVE COMPONENT PARTS AND Thermo Fisher Scientific DOES NOT ASSUME OR AUTHORIZE ANYONE TO ASSUME FOR IT ANY OTHER OBLIGATION.

Thermo Fisher Scientific ASSUMES NO RESPONSIBILITY FOR INCIDENTAL, CONSEQUENTIAL, OR OTHER DAMAGES INCLUDING, BUT NOT LIMITED TO LOSS OR DAMAGE TO PROPERTY, LOSS OF PROFITS OR REVENUE, LOSS OF THE CHILLER, LOSS OF TIME, OR INCONVENIENCE.

This warranty applies to chillers sold by Thermo Fisher Scientific. (Refer to the warranty for chillers sold by the affiliated marketing company of Thermo Fisher Scientific for any additional terms.) This warranty and all matters arising pursuant to it shall be governed by the law of the State of New Hampshire, United States. All legal actions brought in relation hereto shall be filed in the appropriate state or federal courts in New Hampshire, unless waived by Thermo Fisher Scientific.





Thermo Fisher Scientific  
81 Wyman Street  
P.O. Box 9046  
Waltham, Massachusetts 02454-9046  
United States

[www.thermofisher.com](http://www.thermofisher.com)