



Thermo Fisher Scientific

Thermo Scientific SL40 Thermo Scientific SL40R

Instruction Manual

50119930-4

October 2009

© 2009 Thermo Fisher Scientific Inc. All rights reserved.

BIOliner™, BIOShield™, HIGHPlate™, HIGHConic™, AutoLock™, FIBERLite™ and CLINIConic™ are either registered trademarks or trademarks of Thermo Fisher Scientific.

All other trademarks are the property of Thermo Fisher Scientific Inc. and its subsidiaries.

Thermo Fisher Scientific Inc. provides this document to its customers with a product purchase to use in the product operation. This document is copyright protected and any reproduction of the whole or any part of this document is strictly prohibited, except with the written authorization of Thermo Fisher Scientific Inc.

The contents of this document are subject to change without notice. All technical information in this document is for reference purposes only. System configurations and specifications in this document supersede all previous information received by the purchaser.

Thermo Fisher Scientific Inc. makes no representations that this document is complete, accurate or error-free and assumes no responsibility and will not be liable for any errors, omissions, damage or loss that might result from any use of this document, even if the information in the document is followed properly.

This document is not part of any sales contract between Thermo Fisher Scientific Inc. and a purchaser. This document shall in no way govern or modify any Terms and Conditions of Sale, which Terms and Conditions of Sale shall govern all conflicting information between the two documents.

Release history: 50119930-4 printed in October 2009.

For Research Use Only. Not for use in diagnostic procedures.



KONFORMITÄTSERKLÄRUNG

(2006/42/EG; 98/37/EG; 2006/95/EG; 2004/108/EG; 98/79/EG)

DECLARATION OF CONFORMITY

(2006/42/EC; 98/37/EC; 2006/95/EC; 2004/108/EC; 98/79/EC)

DÉCLARATION DE CONFORMITÉ

(2006/42/CE; 98/37/CE; 2006/95/CE; 2004/108/CE; 98/79/CE)

Produkt: **Labor-Zentrifuge**
Product: **Laboratory centrifuge**
Produit: **Centrifugeuse de laboratoire**

Gerät: **Thermo Scientific SL 40**
Model: **Thermo Scientific SL 40R**
Modèle:

Best.-Nr.: **75004512**
Cat.-No.: **75004527**
Référence:

Dieses Produkt wurde in Übereinstimmung mit den Richtlinien 2006/95/EG Niederspannung, 2006/42/EG/ & 98/37/EG Maschinen, 2004/108/EG elektromagnetische Verträglichkeit (EMV) und 98/79/EG In-vitro-Diagnostika (IvD) hergestellt und geprüft.

This product is manufactured and duly carried out in compliance with directions 2006/95/EC Low Voltage, 2006/42/EC/ & 98/37/EC Machinery, 2004/108/EC electromagnetic compatibility (EMC) and 98/79/EC in vitro diagnostic medical devices.

Ce produit est fabriqué et testé selon les directives 2006/95/CE matériel électrique destiné à être employé dans certaines limites de tension, 2006/42/CE & 98/79/CE machines, 2004/108/CE la compatibilité électromagnétique, 98/37/CE dispositifs médicaux de diagnostic in vitro.

Normen / Standards / Normes:

EN 61010-1: 2004 / EN 61010-2-020: 2006 / EN 61010-2-101: 2002
EN 61326-1: 2006 / EN 61326-2-6: 2006 / EN 55011B: 2007 / EN 61000-6-2: 2005
EN ISO 13485: 2003

Osterode, den 03.03.2009

Thermo Electron LED GmbH

Werk Osterode
Am Kalkberg
D-37520 Osterode

Dr. Thomas Reck
Werkleiter

	Name	Datum	Dokument	Revision
Erstellt	Ulrich Lienemann	03.03.2009	75004512-0_50119472.doc	0
Freigegeben	Claus Volhardt	03.03.2009	V:\HSDOC\KONF	

WEEE Conformity

This product is subject to the regulations of the EU Waste Electrical & Electronic Equipment (WEEE) Directive 2002/96 It is marked by the symbol opposite:



Thermo Fisher Scientific has entered into agreements with recycling and disposal companies in all EU Member States for the recycling and disposal of this device. For information on recycling and disposal companies in Germany and on the products of Thermo Fisher Scientific, which fall under the RoHS Directive (Restriction of the use of certain hazardous substances in electrical and electronic equipment), please visit the website www.thermo.com/WEEERoHS.

Table of Contents

	Preface	iii
	Scope of Supply	iii
	Proper Use	iii
	Accident Prevention	iv
	Precautions	iv
Chapter 1	Introduction and Description	1-1
	Characteristics	1-2
	Technical Data	1-3
	Directives, Standards and Guidelines	1-4
	Functions and Features	1-5
	Mains Supply	1-5
	Rotor Selection	1-6
Chapter 2	Before use	2-1
	Before Setting up	2-2
	Transporting the Centrifuge	2-2
	Location	2-2
	Aligning the Centrifuge	2-3
	Mains Connection	2-3
	Storage	2-4
Chapter 3	Control Panel	3-1
	Keys	3-2
	Control Panel	3-2
Chapter 4	Operation	4-1
	Switch on Centrifuge	4-2
	Lid Opening	4-2
	Close Lid	4-2
	Rotor Installation	4-2
	Entering Parameters	4-4
	Saving Programs	4-6
	Centrifugation	4-7
	Temperature Adaptation during Standstill	4-8
	Short-term Centrifugation	4-8
	Removing the Rotor	4-8
	Aerosol-tight Rotors	4-9
	Switching the Centrifuge off	4-9

Chapter 5	System Menu	5-1
Chapter 6	Maintenance and Care	6-1
	Cleaning Intervals	6-2
	Cleaning	6-2
	Disinfection	6-3
	Decontamination	6-4
	Autoclaving	6-5
	Service of Thermo Fisher Scientific	6-6
Chapter 7	Troubleshooting	7-1
	Mechanical Emergency Lid Release	7-2
	Troubleshooting by User	7-3
	When to contact Customer Service	7-6
	Chemical Compatibility Chart	A-1
	Contact Information	B-1

Preface

Before starting to use the centrifuge, read through this instruction manual carefully and follow the instructions.

The information contained in this instruction manual is the property of Thermo Fisher Scientific; it is forbidden to copy or pass on this information without explicit approval.

Failure to follow the instructions and safety information in this instruction manual will result in the expiration of the sellers warranty.

Scope of Supply

Article Number		Quantity	Check
	Centrifuge Thermo Scientific SL40	1	<input type="checkbox"/>
	Power supply cable	1	<input type="checkbox"/>
50119930	Instruction manual	1	<input type="checkbox"/>
70009824	Anti-corrosion oil	1	<input type="checkbox"/>

If any parts are missing, please contact the nearest Thermo Fisher Scientific representative.

Proper Use

- This centrifuge is an IVD accessory, and therefore subject to the Directive 98/79/EC of the European Parliament and the Council of October 27, 1998 on in vitro diagnostic medical devices.
- This centrifuge is a laboratory product designed to separate components by generation of Relative Centrifugal Force. It separates human samples (e.g. blood, urine and other body fluids) collected in appropriate containers, either alone or after addition of reagents or other additives.
- As general-purpose centrifuge, it is designed to also run other containers filled with chemicals, environmental samples and other non-human body samples.
- This centrifuge should be operated by trained specialists only.

Accident Prevention

Prerequisite for the safe operation of the Thermo Scientific SL40 / 40R is a work environment in compliance with standards, directives and trade association safety regulations and proper instruction of the user:

The safety regulations contain the following basic recommendations:

- Maintain a radius of at least 30 cm around the centrifuge.
- Implementation of special measures which ensure that no one can approach the centrifuge for longer than absolutely necessary while it is running.
- The mains plug must be freely accessible at all times. Pull out the power supply plug or disconnect the power supply in an emergency.

Precautions

In order to ensure safe operation of the Thermo Scientific SL40 / 40R, the following general safety regulations must be followed:

- Do not manipulate the safety devices.
- The centrifuge should be operated by trained specialists only.
- The centrifuge is to be used for its intended purpose only.
- Plug the centrifuge only into sockets which have been properly grounded.
- Do not move the centrifuge while it is running.
- Use only rotors and accessories for this centrifuge which have been approved by Thermo Fisher Scientific. Exceptions to this rule are commercially available glass or plastic centrifuge tubes, provided they have been approved for the speed or the RCF value of the rotor.
- Do not use rotors which show any signs of corrosion and/or cracks.
- Do not touch the mechanical components of the rotor and do not make any changes to the mechanical components.
- Use only with rotors which have been properly installed. Follow the instructions on the Autolock in section “[Rotor installation](#)” on [page 4-5](#).
- Use only with rotors which have been loaded properly. Follow the instructions given in the rotor manual.
- Never overload the rotor. Follow the instructions given in the rotor manual.
- Never start the centrifuge when the lid is open.
- Never open the lid until the rotor has come to a complete stop and this has been confirmed in the display.

- The lid emergency release may be used in emergencies only to recover the samples from the centrifuge, e.g. during a power failure (see section “[Mechanical emergency lid release](#)” on [page 7-2](#)).
- Never use the centrifuge if parts of its cover panels are damaged or missing.
- Do not touch the electronic components of the centrifuge or alter any electronic or mechanical components.
- Please observe the safety instructions.

Please pay particular attention to the following aspects:

- Location: well-ventilated environment, set-up on a level and rigid surface with adequate load-bearing capacity.
- Rotor installation: make sure the rotor is locked properly into place before operating the centrifuge.
- Especially when working with corrosive samples (salt solutions, acids, bases), the accessory parts and vessel have to be cleaned carefully.
- Always balance the samples.

centrifugation hazardous substances:

- Do not centrifuge explosive or flammable materials or substances which could react violently with one another.
- The centrifuge is neither inert nor protected against explosion. Never use the centrifuge in an explosion-prone environment.
- Do not centrifuge inflammable substances.
- Do not centrifuge toxic or radioactive materials or any pathogenic micro-organisms without suitable safety precautions.

When centrifugation microbiological samples from the Risk Group II (according to the "Laboratory Bio-safety Manual" of the World Health Organization WHO), aerosol-tight biological seals have to be used.

For materials in a higher risk group, extra safety measures have to be taken.

- If toxins or pathogenic substances have gotten into the centrifuge or its parts, appropriate disinfection measures have to be taken (see “[Disinfection](#)” on [page 6-4](#)).
- Highly corrosive substances which can cause material damage and impair the mechanical stability of the rotor, should only be centrifuged in corresponding protective tubes.

IF A HAZARDOUS SITUATION OCCURS, TURN OFF THE POWER SUPPLY TO THE CENTRIFUGE AND LEAVE THE AREA IMMEDIATELY.

Normal use

The centrifuge is to be used for separating materials of different density or particle size suspended in a liquid.

Maximum sample density at maximum speed: $1,2 \frac{g}{cm^3}$

P Precautions



The symbol on the left refers to general hazards.
ATTENTION means that material damage could occur.
WARNING means that injuries or material damage or contamination could occur.



The symbol on the left refers to biological hazards.
Observe the information contained in the instruction manual to keep yourself and your environment safe.

Introduction and Description

Contents

- “Characteristics” on page 1-2
- “Technical Data” on page 1-3
- “Directives, Standards and Guidelines” on page 1-4
- “Functions and Features” on page 1-5
- “Mains Supply” on page 1-5
- “Rotor Selection” on page 1-6

Characteristics

The Thermo Scientific SL40 / 40R is an in-vitro diagnostics device according to the In-Vitro Diagnostics Directive 98/79/EC.

Several rotors with commercial tubes can be used.

The set speed is reached in seconds. The maintenance-free induction motor ensures quiet and low-vibration operation even at high speeds, and guarantees a very long lifetime.

The user-friendly control panel makes it easy to pre-set the speed, RCF value, running time, temperature, and running profile (acceleration and braking curves). You can choose between the display of speed and RCF or the entry mode.

These settings can be changed even while the centrifuge is running.

With the help of the PULSE-key , you can also centrifuge a sample for just a few seconds, if called for.

The Thermo Scientific SL40 / 40R is equipped with various safety features:

- The housing and rotor chamber consist of steel plate, the interior of armour steel, while the front panel is made of high-impact resistant plastic.
- The lid is equipped with a view port and a lock.
- The lid of the centrifuge can only be opened while the centrifuge is switched on and the rotor has come to a complete stop. The centrifuge cannot be started until the lid has been closed properly.
- The integrated rotor detection systems ensures that no inadmissible speed settings can be preselected.
- Electronic Imbalance recognition
- Lid emergency release: For emergencies only, e.g. during power failures (see [“Mechanical emergency lid release”](#) on [page 7-2](#))

Technical Data

The technical data of the Thermo Scientific SL40 / 40R is listed in the following table.

Table 1-1. Technical Data Thermo Scientific SL40 / 40R

Feature	Value			
Environmental conditions	- use in interior spaces - altitudes of up to 2,000 m above sea level - max. relative humidity 80% up to 31 °C; decreasing linearly up to 50% relative humidity at 40 °C.			
permissible ambient temperature	+2° C to +35° C		+2° C to +35° C	
Overvoltage category	II		II	
Pollution degree	2		2	
Heat dissipation	ventilated		refrigerated	
	230V	120V	230V	120V
	5800 BTU/h	4776 BTU/h	6653 BTU/h	4776 BTU/h
IP	20		20	
running time	unlimited		unlimited	
maximum speed n_{max}	15200 rpm (depending on the rotor)		15200 rpm (depending on the rotor)	
minimum speed n_{min}	300 rpm		300 rpm	
maximum RCF value at n_{max}	25314 xg		25314 xg	
maximum kinetic energy	< 62,5 kJ		< 62,5 kJ	
noise level at maximum speed	< 64dB (A)		< 64dB (A)	
temperature setting range	-10 °C to +40 °C			
Dimensions	ventilated		refrigerated	
	Height	360 mm	360 mm	
	Width	550 mm	745 mm	
	Depth	670 mm	670 mm	
Table top height	310 mm		310 mm	
weight without rotor	86 kg		116 kg	

Directives, Standards and Guidelines

Table 1-2. Directives, standards and guidelines

Tension / Frequency		Produced and inspected according to the following standards and guidelines
230V 50/60Hz	2006/95/EC Low Voltage Directive: 2006/42/EC & 98/37/EC Machine Directive: 2004/108/EC EMC Directive 98/79/EC In-vitro-Diagnostika (IvD)	EN 61010-1, 2 nd Edition EN 61010-2-020, 2 nd Edition EN 61010-2-101 EN 61326-1 EN 61326-2-6 EN 55011B EN 61000-6-2 EN ISO 13485
230V 60Hz 120V 60Hz 100V 60Hz	The centrifuges are produced and inspected according to the following standards and guidelines	UL 61010-1, 2 nd Edition CAN/CSA-C22.2 No. 61010-1, 2 nd Edition IEC 61010-2-20, 2 nd Edition (Pollution degree 2, Overvoltage category II) IEC 61010-2-101 Emitted interference FCC Part 15 CLASS A NOTE: This equipment has been tested and found to comply with the limits for a Class A digital device, pursuant to Part 15 of the FCC Rules. These limits are designed to provide reasonable protection against harmful interference when the equipment is operated in a commercial environment. This equipment generates, uses, and can radiate radio frequency energy and, if not installed and used in accordance with the instruction manual, may cause harmful interference to radio communications. Operation of this equipment in a residential area is likely to cause harmful interference in which case the user will be required to correct the interference at his own expense.
100V 50Hz		IEC 61010-1 2 nd Edition IEC 61010-2-020 2 nd Edition IEC 61010-2-101 EN 61326-1 EN 61326-2-6 EN 55011A EN 61000-6-2 EN ISO 13485

Functions and Features

The following table gives an overview of the important functional and performance characteristics of the Thermo Scientific SL40 / 40R.

Table 1-3. Functions and features

Component / Function	Description / Features
Structure / Housing	Galvanized steel chassis with armoured plating.
Chamber	Stainless steel
Drive	Induction drive without carbon brushes
Keys and display	Easy-to-clean keypad and display surface
Controls	Microprocessor-controlled
Internal memory	The most recent data is saved
Functions	RCF-selection, temperature control, pretemp with cooling equipped devices
Acceleration / braking profiles	9 acceleration and 10 braking curves
Rotor recognition	Automatic
Imbalance recognition	Electronic, contingent on rotor and speed
Lid lock	Automatic lid closing and locking starting from an initial hold position

Mains Supply

The following table contains an overview of the electrical connection data for the Thermo Scientific SL40 / 40R. This data is to be taken into consideration when selecting the mains connection socket.

Table 1-4. Electrical connection data of the Thermo Scientific SL40 / 40R

Cat. No.		Mains voltage	Frequency	Rated current	Power consumption	Equipment fuse	Building fuse
7500 4527	refrigerated	230 V	50 / 60 Hz	10,5 A	1950 W	15 AT	16 AT
7500 4528	refrigerated	120 V	60 Hz	12 A	1400 W	15 AT	15 AT
7500 4512	ventilated	230 V	50 / 60 Hz	11 A	1700 W	15 AT	16 AT
7500 4513	ventilated	120 V	60 Hz	12 A	1400 W	15 AT	15 AT

Rotor Selection

The Thermo Scientific SL40 / 40R is supplied without a rotor. Various rotors are available to choose from.

TX-750	7500 3607
with round buckets	7500 3608
with rectangular buckets	7500 3614
incl. Microtiter carrier	7500 3617
incl. ABI-bucket	7500 3618
BIOShield™ 1000A	7500 3603
BIOLiner™	7500 3667
FIBERLite™ F15-6 x 100 CFK	7500 3698
FIBERLite™ F21-48 x 2	7500 3664
Microliter 48 x 2	7500 3602
HIGHConic™ 6 x 100	7500 3620

The technical data of the rotors and the corresponding adapters and reduction sleeves for various commercially available containers can be found in the corresponding rotor operating manuals.

For more information visit our website at: <http://www.thermo.com>

Before use

Contents

- “Before Setting up” on page 2-2
- “Transporting the Centrifuge” on page 2-2
- “Location” on page 2-2
- “Aligning the Centrifuge” on page 2-3
- “Mains Connection” on page 2-3
- “Storage” on page 2-4

Before Setting up

1. Check the centrifuge and the packaging for any shipping damage.
Inform the shipping company and Thermo Fisher Scientific immediately if any damage is discovered.
2. Remove the packaging.
3. Check the order for completeness (see “[Scope of Supply](#)” on [page iii](#).).
If the order is incomplete, please contact Thermo Fisher Scientific.

Transporting the Centrifuge

- Due to its weight (see “[Technical Data](#)” on [page 1-3](#)), the centrifuge should be carried by several people.
- Always lift the centrifuge at both sides.

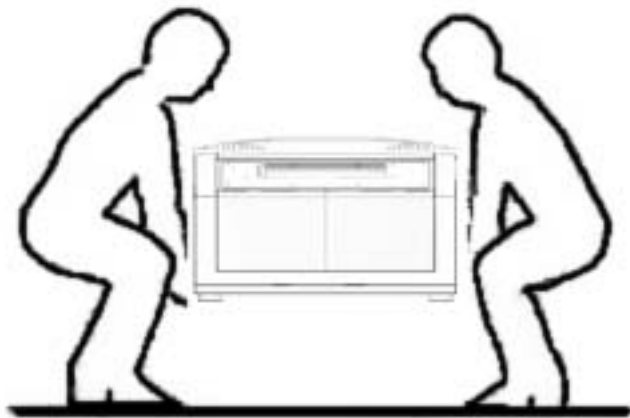

Figure 2-1. Lifting the centrifuge at both sides.

- The centrifuge can be damaged by impacts.
- Transport the centrifuge upright and if at all possible in its packaging.



WARNING Always lift the centrifuge on both sides.
Never lift the centrifuge by its front or the back panel.
Always remove the rotor before moving the centrifuge.

Location

The centrifuge should only be operated indoors.

The set-up location must fulfil the following requirements:

- A safety zone of at least 30 cm must be maintained around the centrifuge.
People and hazardous substances must be kept out of the safety zone while centrifugation.

- The supporting structure must be stable and free of resonance, for example a level laboratory bench.
- The supporting structure must be suitable for horizontal setup of the centrifuge.
- The centrifuge should not be exposed to heat and strong sunlight.



WARNING UV rays reduce the stability of plastics.
Do not subject the centrifuge, rotors and plastic accessories to direct sunlight.

- The set-up location must be well-ventilated at all times.

Aligning the Centrifuge

The alignment of the centrifuge must be checked every time after moving it to a different location. The supporting structure must be suitable for horizontal setup of the centrifuge.



CAUTION If the centrifuge isn't level, imbalances can occur and the centrifuge can be damaged.
Do not place anything under the feet to level the centrifuge.

Mains Connection

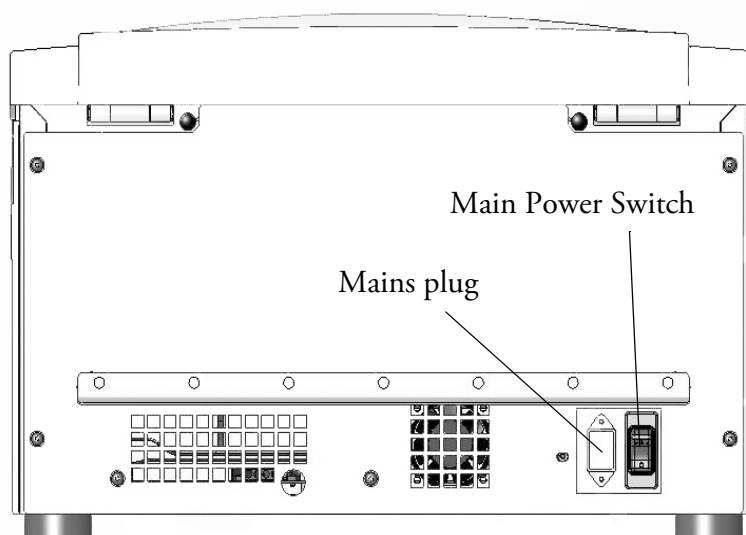

Figure 2-2. Mains connections

1. Turn off the power supply switch on the back (press "0").
2. Plug the centrifuge into grounded electrical sockets only.
3. Check whether the cable complies with the safety standards of your country.

4. Make sure that the voltage and frequency correspond to the figures on the rating plate.

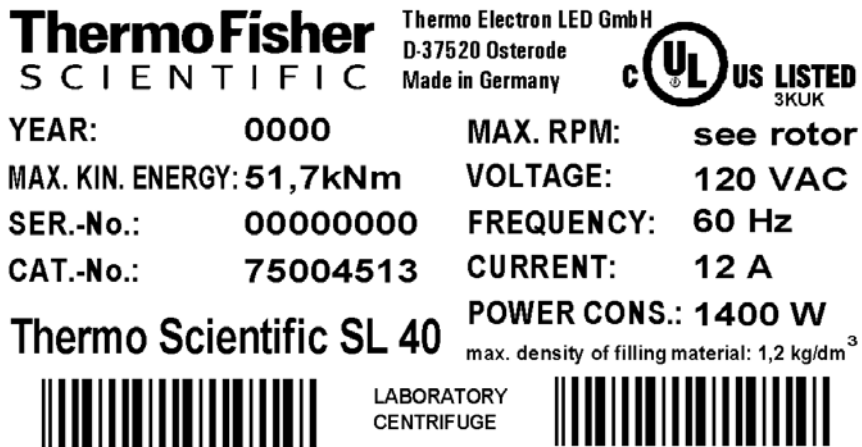

Figure 2-3. Rating plate of the Thermo Scientific SL40

5. Establish the connection to the power supply with the connecting cable.

Storage

- Before storing the centrifuge and the accessories it must be cleaned and if necessary disinfected and decontaminated.
- Store the centrifuge in a clean, dust-free location.
- Be sure to place the centrifuge on its feet.
- Avoid direct sunlight.







Control Panel

Contents

- “Keys” on page 3-2
- “Control Panel” on page 3-2

Keys

The keys allow user intervention for controlling the operating mode as follows:

key		display contents
	Start	Normal start of the centrifuge
	Stop	End run manually
	Open lid	Release (possible only when device is switched on). Release during power failure: see "Mechanical emergency lid release" on page 7-2)
	Pulse	By pressing the "PULSE" key the centrifuge starts immediately and accelerates up to the end speed. Releasing the key initiates a stopping process at the highest braking curves.
	Change value	Use the arrow buttons in order to modify the displayed value.
	Snow symbol	Press the snow symbol key for prewarming or precooling the centrifuge.
	Changing the display mode	Use the CHANGE key to change the display mode. (Speed / RCF-value)

Control Panel

The control panel contains the keys and displays of the centrifuge (only the power switch is located on the back of the device). All parameters can be selected and changed during operation.

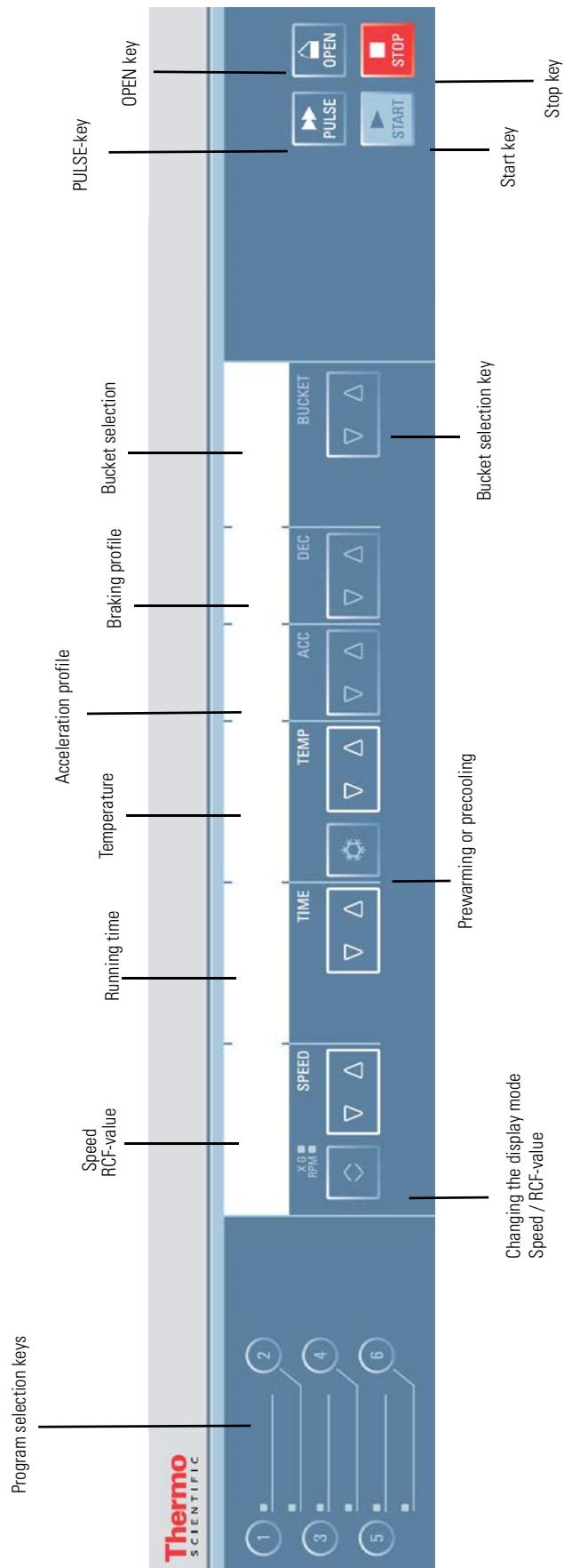

Operation

Contents

- “Switch on Centrifuge” on page 4-2
- “Lid Opening” on page 4-2
- “Close lid” on page 4-2
- “Rotor Installation” on page 4-2
- “Entering Parameters” on page 4-4
- “Saving Programs” on page 4-6
- “Centrifugation” on page 4-7
- “Temperature Adaptation during Standstill” on page 4-8
- “Short-term Centrifugation” on page 4-8
- “Removing the Rotor” on page 4-8
- “Switching the Centrifuge off” on page 4-9

Switch on Centrifuge

1. Turn on the power switch on the back of the device.
The device performs a self-check of its software.
 - a. When the centrifuge lid is closed the following display shows:

0 0:00 -10 9 9 3608

The speed and time displays read 0. The temperature indicator displays the current temperature inside the rotor chamber. The preset acceleration and braking curves and the selected bucket are also displayed.

- b. When the centrifuge lid is open the following display shows:

15000 1:30 -10 9 9 3608

The speed and time displays show the preset values. The temperature indicator displays the current temperature inside the rotor chamber. The preset acceleration and braking curves and the selected bucket are also displayed.

Lid Opening

1. Press the "OPEN" key .



WARNING Do not reach into the crack between the lid and the housing. The lid is drawn shut automatically.
Use the emergency release only for malfunctions and power failures (see [“Mechanical emergency lid release”](#) on page 7-2).

Close Lid

Close the lid by pressing down on it lightly in the middle or on both sides of it. One lock closes the lid completely. The lid will close automatically.



WARNING Do not reach into the crack between the lid and the housing. The lid is drawn shut automatically.

Note The lid should audibly click into place.

Rotor Installation

The approved rotors for the Thermo Scientific SL40 / 40R are listed in section [“Rotor selection”](#) on page 1-7. Use only the rotors and accessories from this list in the centrifuge.



CAUTION Unapproved or incorrectly combined accessories can cause serious damage to the centrifuge.

The rotors are equipped with an AutoLock™ locking system.

This system is used to automatically lock the rotor to the centrifuge spindle. The rotor does not have to be bolted onto the centrifuge spindle.

Proceed as follows:

1. Open the lid of the centrifuge and if necessary remove any dust, foreign objects or residue from the chamber.
AutoLock™ and o-ring must be clean and undamaged.

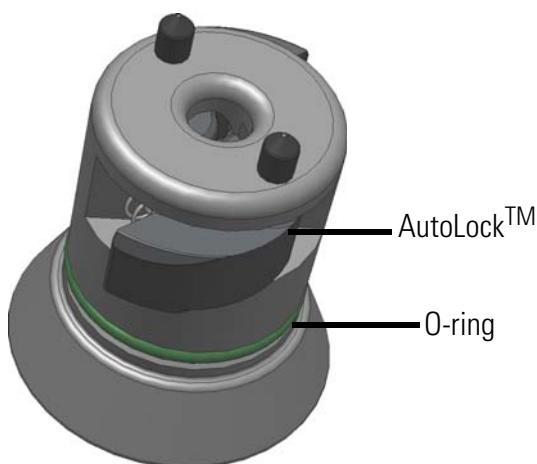

Figure 4-1. AutoLock™

2. Hold the rotor over the shaft and let it slide slowly down the centrifuge spindle.
The rotor clicks automatically into place.



CAUTION Do not force the rotor onto the centrifuge spindle. If the rotor is very light, then it may be necessary to press it onto the centrifuge spindle with a small amount of pressure.

3. Check if the rotor is properly installed by lifting it slightly on the handle. If the rotor can be pulled up, then it must be reclamped to the centrifuge spindle.



WARNING If the rotor cannot be properly locked in place after several attempts, then the AutoLock™ is defective and you are not permitted to operate the rotor. Check for any damage to the rotor: Damaged rotors must not be used. Keep the hub area clear of objects.



CAUTION Check that the rotor is properly locked on the centrifuge spindle before each use by pulling it a its handle.

4. Place the rotor lid onto the rotor.



Be sure to check all sealings before starting any aerosol-tight applications. See the information in the rotor instruction manual.

5. Close the centrifuge lid.

Entering Parameters

The Thermo Scientific SL40 offers you a total of 9 acceleration and 10 braking curves with which samples and gradients can be centrifuged.

After the centrifuge is turned on, the last running profile selected is shown.

Acceleration Curve

1. Press the  key below the ACC display in order to open the acceleration profile selection menu.
The display shows the message "Acceleration"



Set acceleration 9

2. Select the profile by pressing the  key, until the desired acceleration curve shows.

Braking Profile



1. Press the  key below the DEC display in order to open the braking profile selection menu.
The display shows the message "Set Deceleration"



Set deceleration 9

2. Select the profile by pressing the  key, until the desired deceleration curve shows.

Preselecting Speed / RCF

1. Press the  key below the "SPEED" display.
The display shows the "RPM" or the "RCF"-value depending on the display setting. Press the  key to toggle between the two values.



24400 x9 Set RCF
15000 rpm Set speed

2. Enter the desired value by pressing the  key repeatedly, until the desired value shows.

Note If an extremely low RCF value has been selected, it will be corrected automatically if the resulting speed is less than 300 rpm.

Explanation of RCF Value

The relative centrifugal force is given as a multiple of the force of gravity g. It is a unitless numerical value which is used to compare the separation or sedimentation capacity of various devices, since it is independent of the type of device. It simply involves the rotational radius and the rotating speed:

$$RCF = 11,18 \times \left(\frac{n}{1000} \right)^2 \times r$$

r = Rotational radius in cm

n = Speed in rpm

The maximum RCF value is related to the maximum radius of the tube.

Remember that this value is reduced depending on the tubes and adapters used.

This can be accounted for in the calculation above if required.

Running time preselection

1. Press the  key below the TIME display in order to open the runtime selection menu. The display shows the message "Set Time". Enter the desired runtime in hh:mm

0.14 Set time H.MM

2. Enter the desired value by pressing the  key repeatedly, until the desired value shows.

Continuous Operation

1. Press the "START" key . During continuous operation, the centrifuge will continue running until you stop it manually.

HOLD Non-Stop mode

Preselecting the Temperature

You can preselect temperatures between -10 °C and +40 °C.

To set the temperature, proceed as follows:

1. Press the  key below the TEMPERATURE display in order to open the temperature selection menu. The display shows "Set temp".

Set temp - 10°C

2. Enter the desired value by pressing the  key repeatedly, until the desired value shows.

Prewarming or Precooling the Centrifuge

For setting the pretemp value for the centrifuge proceed as follows:

1. Press the  key below the TEMPERATURE display in order to open the temperature selection menu.

The display shows the message "Set PreTemp"



2. Enter the desired value by pressing the  key repeatedly, until the desired value shows.



3. Close the centrifuge lid.



The display shows the current temperature inside the rotor chamber.

4. Press the "START" key .



The rotor chamber is cooled down or heated up to the preset temperature.



5. Press the "STOP" key .

The display shows the current temperature inside the rotor chamber.

Bucket Selection

Bucket selection is only possible for swing-out rotors. The bucket code corresponds to the last four digits of the bucket catalog number.

1. Press the "BUCKET" key.
The display shows the following message:



2. Press the BUCKET key repeatedly until the bucket being used is displayed.

Saving Programs

1. Enter the program parameters.
2. Press any of the program store keys for 5 seconds.

Centrifugation

Once the rotor has been properly installed, the main switch has been turned on and the lid has been closed, you can start centrifugation.

Starting Centrifuge Program

Press the START key  on the control panel. The centrifuge accelerates to the pre-set speed with the time display active.

If the speed setting is higher than the maximum permissible speed or RCF-value for the particular rotor, then the display will show the message max. 4,700 rpm once the centrifuge has been started.

Within 15 seconds you can apply this value by pressing the "START" key  again, and the centrifugation program will continue. Otherwise the centrifuge will stop and you will have to enter a valid number.

You cannot open the lid as long as the centrifuge is running.

Imbalance Indicator

If a load is imbalanced, this will be indicated at speed higher than approx. 300 rpm by the message "Imbalanced load".

The run will terminate.

Check the loading and start the centrifuge once again. See the information on proper loading in the rotor instruction manual. For information on troubleshooting, see section "[Troubleshooting by user](#)" on [page 7-4](#).

Stopping the Centrifugation Program



With preset Running Time

Usually the running time is preset and you only have to wait until the centrifuge stops automatically when the preset time limit expires.

As soon as the speed drops to zero, the message "END" will appear in the display. By pressing the OPEN key , you can open the lid and remove the centrifuged material.

You can also stop the centrifugation program manually at any time by pressing the  "Stop" key.

Continuous Operation

If you selected continuous operation (see "[Continuous Operation](#)" on [page 4-5](#)), you will have to stop the centrifuge manually. Press the STOP key  on the control panel. The centrifuge will be decelerated at the designated rate. The message "END" will illuminate, and after pressing the OPEN key , the lid will open and you can remove the centrifuged material.

Temperature Adaptation during Standstill

The temperature cannot be adapted until the rotor has been positively identified; the speed display will then show "END".

When the rotor is not recognized (lid closed and START key  not yet pressed, speed display "0"), the centrifuge responds by ensuring that the sample cannot freeze regardless of the rotor being used.

Short-term Centrifugation

For short-term centrifugation, the Thermo Scientific SL40 / 40R has a "Pulse" - function.

By holding down the PULSE key , spinning will start and continue until the key is let go.

The centrifuge accelerates and brakes at maximum power. Any rpm or RCF entered beforehand is overridden.

Note The centrifuge accelerates to maximum speed, regardless of which rotor was installed.

Check carefully whether you have to maintain a certain speed for your application.

During the acceleration process, time is counted forwards in seconds. The reading stays displayed until the centrifuge lid is opened.

Removing the Rotor

To remove the rotor, proceed as follows:

1. Open the centrifuge lid.
2. Grab the rotor handle with both hands and press against the green AutoLock™ key. At the same time, pull the rotor directly upwards with both hands and remove it from the motor shaft. Make sure not to jam the rotor while doing this.

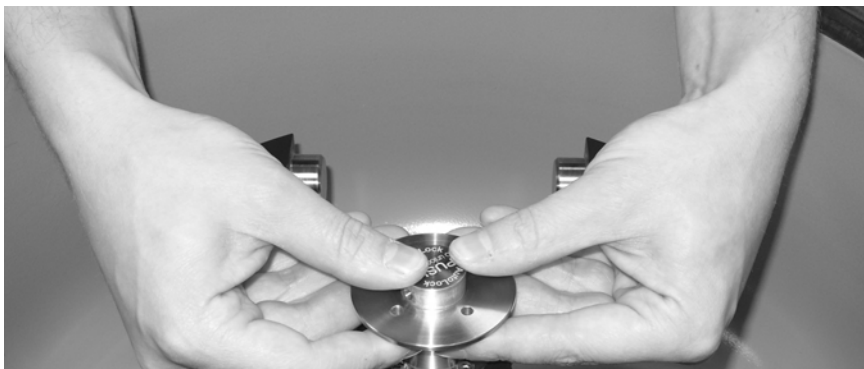

Aerosol-tight Rotors

When using a lid sealed against aerosols, you can only remove the rotor with the rotor lid closed! This is for your personal safety and to ensure the integrity of the samples.



CAUTION Rotors supplied with a lid for aerosol-tight applications come with a mandril, which belongs to the AutoLock™. Be sure not to place the lid onto this mandril to prevent it from being damaged.

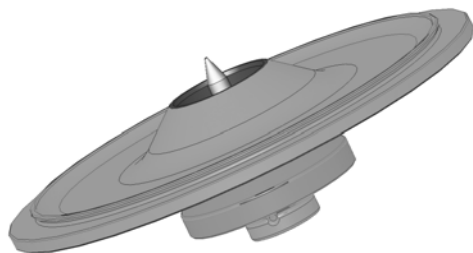

Figure 4-2. AutoLock™-lid for aerosol-tight rotors



WARNING Mind the AutoLock™-mandril inside the lid. Do not touch.

Switching the Centrifuge off

1. To turn off the centrifuge put the mains switch to "0".

System Menu

To enter the system menu hold down any of the keys when switching the centrifuge on.

To modify setting, use the Δ ∇ keys.

- Use the Δ ∇ keys for the speed fields to navigate in the system menu.
- Use the Δ ∇ keys for the bucket field to navigate from one system menu item to the next.

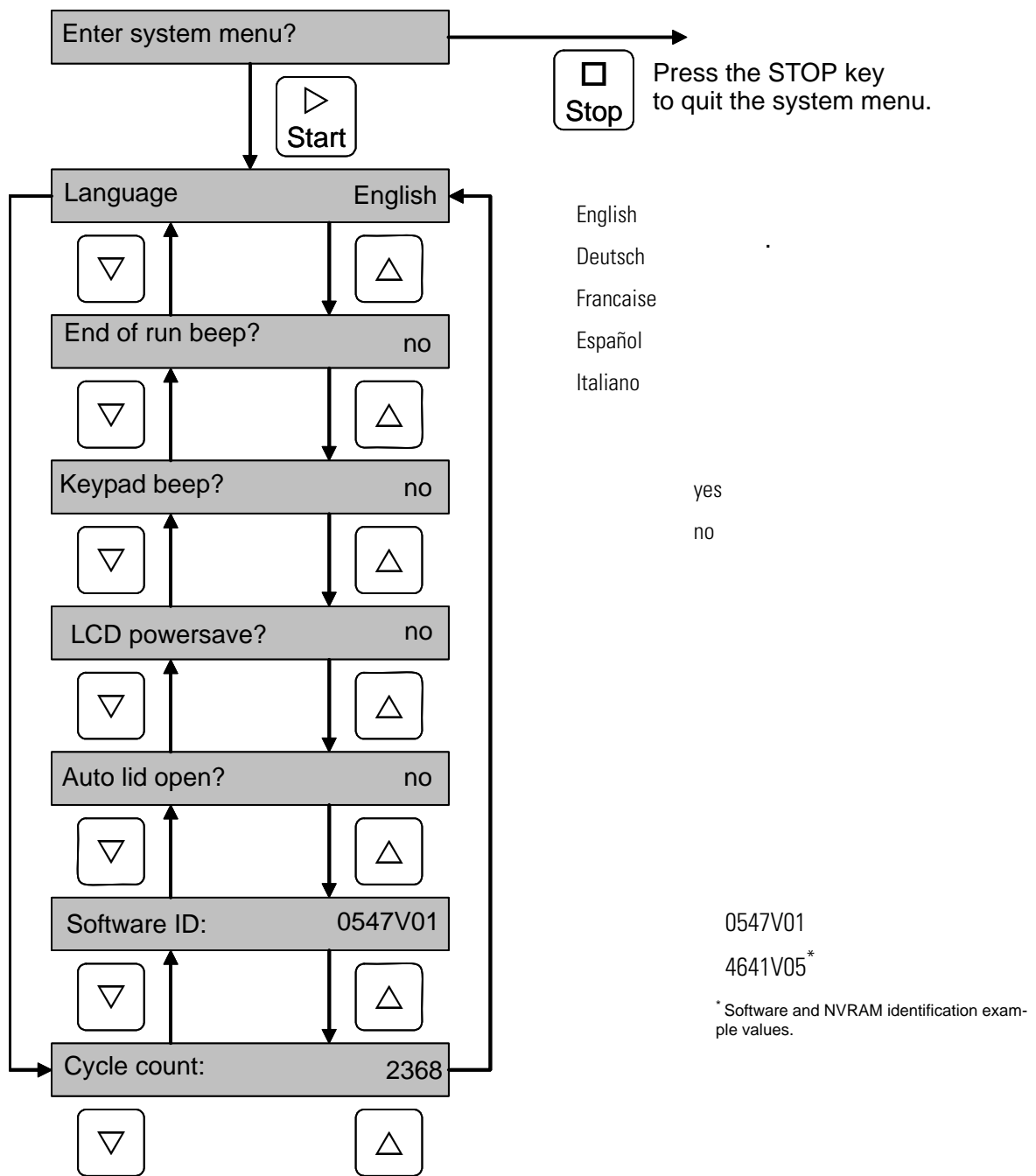

Maintenance and Care

Contents

- “Cleaning Intervals” on page 6-2
- “Cleaning” on page 6-2
- “Disinfection” on page 6-3
- “Decontamination” on page 6-4
- “Autoclaving” on page 6-5
- “Service of Thermo Fisher Scientific” on page 6-6

Cleaning Intervals

For the sake of personal, environmental, and material protection, it is your duty to clean and if necessary disinfect the centrifuge on a regular basis.

Maintenance	Recommended interval
Clean rotor chamber	daily or when polluted
Clean rotor	daily or when polluted
Accessories	daily or when polluted
Cabinet	Once per month
Ventilation holes	Every six months



CAUTION Refrain from using any other cleaning or decontamination procedure than those recommended here, if you are not entirely sure that the intended procedure is safe for the equipment.
Use only approved cleansers.
If in doubt, contact Thermo Fisher Scientific.

Cleaning

When cleaning centrifug

- Use warm water with a neutral solvent.
- Never use caustic cleaning agents such as soap suds, phosphoric acid, bleaching solutions or scrubbing powder.
- Rinse the cavities out thoroughly.
- Use a soft brush without metal bristles to remove stubborn residue.
- Afterwards rinse with distilled water.
- Place the rotors on a plastic grate with their cavities pointing down.
- If drying boxes are used, the temperature must never exceed 50 °C, since higher temperatures could damage the material and shorten the lifetime of the parts.
- Use only disinfectants with a pH of 6-8.
- Dry aluminum parts off with a soft cloth.
- After cleaning, treat the entire surface of aluminum parts with corrosion protection oil (7000 9824). Also treat the cavities with oil.
- Store the aluminum parts at room temperature or in a cold-storage room with the cavities pointing down.



CAUTION Before using any cleaning or decontamination methods except those recommended by the manufacturer, users should check with the manufacturer that the proposed method will not damage the equipment.

Clean centrifuge and accessories as follows:

1. Open the centrifuge.
2. Turn off the centrifuge.
3. Pull out the power supply plug.
4. Grasp the rotor with both hands and lift it vertically off the centrifuge spindle.
5. Remove the centrifuge tubes and adaptors.
6. Use a neutral cleaning agent with a pH value between 6 and 8 for cleaning.
7. Dry all of the rotors and accessories after cleaning with a cloth or in a warm air cabinet at a maximum temperature of 50°C.
8. Clean the housing of the centrifuge as needed.
 - After cleaning, treat the entire surface of aluminum parts with corrosion protection oil (7000 9824). Also treat the cavities with oil.
 - Treat the end of the swing out rotor with end grease (75003786).



CAUTION When cleaning, do not allow liquids, especially organic solvents, to get on the drive shaft, the bearings, the AutoLock™ or the locks. Organic solvents break down the grease in the motor bearing. The drive shaft could freeze up.

After some applications there might be ice in the rotor chamber. Let the ice melt and drain it off. Clean the rotor chamber as described above.

Disinfection

Disinfect the centrifuge immediately whenever infectious material has spilled during centrifugation.



WARNING Infectious material can get into the centrifuge when a tube breaks or as a result of spills. Keep in mind the risk of infection when touching the rotor and take all necessary precautions. In case of contamination, make sure that others are not put at risk. Decontaminate the affected parts immediately. Take other precautions if needed.

Use a sprayer whenever possible so that all surfaces are covered evenly.

The rotor chamber and the rotor should be treated preferably with a neutral disinfectant. A disinfectant spray would be most suitable for this purpose so that the rotor and accessory surfaces are covered evenly.



CAUTION Before using any cleaning or decontamination methods except those recommended by the manufacturer, users should check with the manufacturer that the proposed method will not damage the equipment. Observe the safety precautions and handling instructions for the cleaning agents used.

Contact the Service Department of Thermo Fisher Scientific for questions regarding the use of other disinfectants.

Disinfect the rotor and accessories as follows:

1. Open the centrifuge.
2. Turn off the centrifuge.
3. Pull out the power supply plug.
4. Grasp the rotor with both hands and lift it vertically off the centrifuge spindle.
5. Remove the centrifuge tubes and adaptors and dispose of them or disinfect them.
6. Treat the rotor and accessories according to the instructions for the disinfectant (spray or soak in solution). Adhere strictly to the given application times.
7. Be sure the disinfectant can drain off the rotor.
8. Rinse the rotor and rotor lid thoroughly with water and then rub down.
9. Dispose of the disinfectant according to the applicable guidelines.
10. Dry all of the rotors and accessories after cleaning with a cloth or in a warm air cabinet at a maximum temperature of 50°C.
 - After cleaning, treat the entire surface of aluminum parts with corrosion protection oil (7000 9824). Also treat the cavities with oil.
 - Treat the rotor with rotor grease (75003786).

Decontamination

Decantamine the centrifuge immediately whenever radioactive material has spilled during centrifugation.



WARNING Radioactive material can get into the centrifuge when a tube breaks or as a result of spills. Keep in mind the risk of infection when touching the rotor and take all necessary precautions.

In case of contamination, make sure that others are not put at risk.

Decontaminate the affected parts immediately.

Take other precautions if need be.



CAUTION Before using any cleaning or decontamination methods except those recommended by the manufacturer, users should check with the manufacturer that the proposed method will not damage the equipment.

For general radioactive decontamination use a solution of equal parts of 70% ethanol, 10% SDS and water.

Disinfect the rotor and accessories as follows:

1. Open the centrifuge.
2. Turn off the centrifuge.

3. Pull out the power supply plug.
4. Grasp the rotor with both hands and lift it vertically off the centrifuge spindle.
5. Remove the centrifuge tubes and adaptors and dispose of them or disinfect them.
6. Rinse the rotor first with ethanol and then with de-ionized water.
 - Adhere strictly to the given application times.
7. Be sure the decontamination solution can drain off the rotor.
8. Rinse the rotor and accessories thoroughly with water.
9. Dispose of the decontamination solution according to the applicable guidelines.
10. Dry all of the rotors and accessories after cleaning with a cloth or in a warm air cabinet at a maximum temperature of 50°C.
 - After cleaning, treat the entire surface of aluminum parts with corrosion protection oil (7000 9824). Also treat the cavities with oil.
 - Treat the body of the swing out rotor with grease (75003786).

Autoclaving

1. Before autoclaving clean rotor and accessories as described above.
2. Place the rotor on a flat surface.
 - Rotors and adapter can be autoclaved at 121 °C.
 - The maximum permissible autoclave cycle is 20 minutes at 121 °C.

Clean the rotor before autoclaving and rinse it with distilled water. Remove all accessories (tubes, adapters) from the rotor. Place the rotor on a flat surface.

Note No chemical additives are permitted in the steam.



CAUTION Never exceed the permitted temperature and duration when autoclaving. If the rotor shows signs of corrosion or wear, it must be replaced.

Service of Thermo Fisher Scientific

Thermo Fisher Scientific recommends having the centrifuge and accessories serviced once a year by an authorized service technician. The service technicians check the following:

- the electrical equipment
- the suitability of the set-up site
- the lid lock and the safety system
- the rotor
- the fixation of the rotor and the drive shaft

Thermo Fisher Scientific offers inspection and service contracts for this work.

Troubleshooting

Contents

- “Mechanical Emergency Lid Release” on page 7-2
- “Troubleshooting by User” on page 7-3
- “When to contact Customer Service” on page 7-6

Mechanical Emergency Lid Release

During a power failure, you will not be able to open the centrifuge lid with the regular electric lid release. A mechanical override is provided to allow sample recovery in the case of an emergency. However, this should be used only in emergencies and after the rotor has come to a complete stop.



WARNING The rotor can still be spinning at high speed. If touched, it can cause serious injuries.

Always wait a few minutes until the rotor has come to a stop without braking. The brake does not work when there is no current. The braking process lasts much longer than usual.

Proceed as follows:

1. Make sure the rotor has stopped (view port in the lid).



WARNING Never use your hand or other tools to brake the rotor.

2. Pull out the power supply plug.
3. On the back of the housing are two black plastic plugs which you can pry out of the back plate with a screwdriver or a knife.
4. Pull the release cord attached to it at the same time to trigger the mechanical lid release. The lid will open and the samples can be removed.

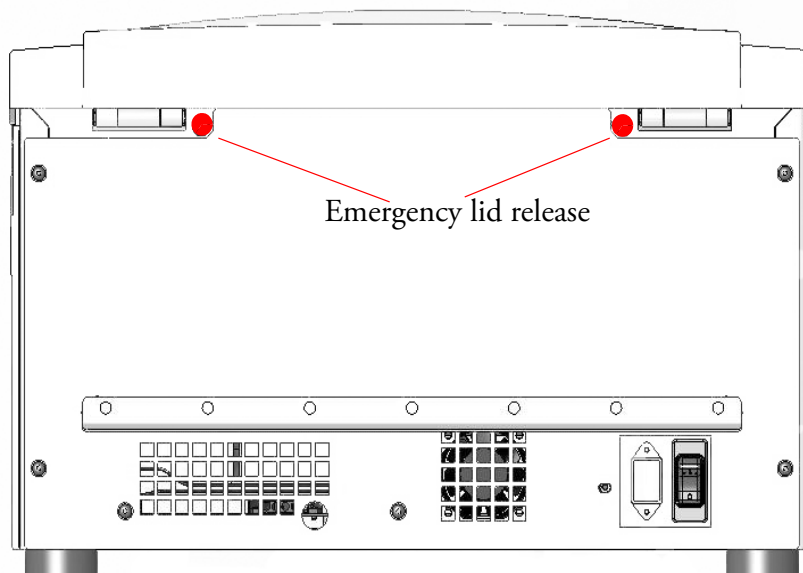



Figure 7-1. Emergency lid release

5. Push the cords back into the centrifuge and mount the plugs.

Reconnect the centrifuge once the power has been restored. Switch on the centrifuge. Press the OPEN key  to have the lid locks operative again.

Troubleshooting by User



If problems occur other than those listed in this table, the authorized customer service representative must be contacted.

Failure message	Problem with centrifuge	Possible causes and cures
Overtemperature	The centrifuge cannot be operated. The run does not start or the centrifuge runs down without being braked.	Overheating in chamber. Check the function of the refrigeration unit. Clean the air inlet for the condenser. Restart the centrifuge. If an error message appears again, inform Customer Service.
Incorrect bucket ID	The centrifuge cannot be operated. The run does not start or the centrifuge runs down without being braked.	Bucket code is undefined for the rotor detected, check the set points for the given bucket code. Is it permitted to use the current bucket in the rotor currently mounted? Restart the centrifuge. If an error message appears again, inform Customer Service.
Unapproved rotor	The centrifuge cannot be operated. The run does not start or the centrifuge runs down without being braked.	Rotor code is not in the rotor table. Is it permitted to use the rotor currently mounted in this device? Restart the centrifuge. If an error message appears again, inform Customer Service.
Rotor ID failure	The centrifuge cannot be operated. The run does not start or the centrifuge runs down without being braked.	The rotor could not be identified. Check to see if the rotor is properly installed. Restart the centrifuge. If an error message appears again, inform Customer Service.
Lid blocked	Centrifuge does not open	Restart the centrifuge. The emergency lid release enables you to retrieve your samples. If an error message appears again, inform Customer Service.
Motor overtemp.	The centrifuge cannot be operated. The run does not start or the centrifuge runs down without being braked.	Restart the centrifuge. If an error message appears again, inform Customer Service.
PCB overtemp.	The centrifuge cannot be operated. The run does not start or the centrifuge runs down without being braked.	Restart the centrifuge. If an error message appears again, inform Customer Service.
Emergency release	The centrifuge cannot be operated. The run does not start or the centrifuge runs down without being braked.	The lid opens while the device is running. Close the lid and restart the centrifuge. If an error message appears again, inform Customer Service.



Failure message	Problem with centrifuge	Possible causes and cures
Imbalanced load	The centrifuge cannot be operated. The run does not start or the centrifuge runs down without being braked.	Imbalance detected. Check the load placed in the rotor. Check that the rotor cross bolts are well greased. Restart the centrifuge. If an error message appears again, inform Customer Service.
Check Set Speed	The centrifuge cannot be operated. The run does not start or the centrifuge runs down without being braked.	The set point speed is higher than the maximum rotor speed. Correct the value. Restart the centrifuge. If an error message appears again, inform Customer Service.
E-01 - E-12	The centrifuge cannot be operated. The run does not start or the centrifuge runs down without being braked.	Error during the self-test of the centrifuge program and the electronics. Restart the centrifuge. If an error message appears again, inform Customer Service.
E-13	The centrifuge cannot be operated. The run does not start or the centrifuge runs down without being braked.	The check sum in the data memory is incorrect. The software corrects errors automatically. Check the values of the set point settings, etc. Restart the centrifuge. If an error message appears again, inform Customer Service.
E-15 - E-16	Temperature sensor broken / controller defective	Malfunction in the temperature detection. Restart the centrifuge. If an error message appears again, inform Customer Service.
E-17	Speed for rotor detection exceeded	Restart the centrifuge. If an error message appears again, inform Customer Service.
E-21 - E-22	The centrifuge cannot be operated. The run does not start or the centrifuge runs down without being braked.	The rotor could not be identified. Check to see if the rotor is properly installed. Restart the centrifuge. If an error message appears again, inform Customer Service.
E-23	The centrifuge cannot be operated. The run does not start or the centrifuge runs down without being braked.	The speed control measurement returned a different result. Restart the centrifuge. If an error message appears again, inform Customer Service.
E-25-E-27	The centrifuge cannot be operated. The run does not start or the centrifuge runs down without being braked.	Time has expired for the lid lock drive while opening the lid. Restart the centrifuge. If an error message appears again, inform Customer Service.
E-28	The centrifuge cannot be operated. The run does not start or the centrifuge runs down without being braked.	Error during the self-test of the centrifuge program and the electronics. Restart the centrifuge. If an error message appears again, inform Customer Service.

Failure message	Problem with centrifuge	Possible causes and cures
E-29	The centrifuge cannot be operated. The run will not be started.	Is the rotor properly installed? Is it easy to turn the rotor when the lid is open? Does the rotor rub against the device? Restart the centrifuge. If an error message appears again, inform Customer Service.
E-30	The centrifuge cannot be operated. The run does not start or the centrifuge runs down without being braked.	Restart the centrifuge. If an error message appears again, inform Customer Service.
E-33	The centrifuge cannot be operated. The run does not start or the centrifuge runs down without being braked.	Overpressure in the refrigeration unit. Clean the air inlet for the condenser. Restart the centrifuge. If an error message appears again, inform Customer Service.
E-34-E-36	The centrifuge cannot be operated. The run does not start or the centrifuge runs down without being braked.	Error during the self-test of the centrifuge program and the electronics. Restart the centrifuge. If an error message appears again, inform Customer Service.
E-40	The centrifuge cannot be operated. The run does not start or the centrifuge runs down without being braked.	The centrifuge accelerates too slowly. Is the rotor properly installed? Check whether you selected the right bucket. Is it easy to turn the rotor when the lid is open? Does the rotor rub against the device? Restart the centrifuge. If an error message appears again, inform Customer Service.
E-41-E-74	The centrifuge cannot be operated. The run does not start or the centrifuge runs down without being braked.	Error during the self-test of the centrifuge program and the electronics. Restart the centrifuge. If an error message appears again, inform Customer Service.

When to contact Customer Service

If you need to contact customer service, please provide the order no. and the serial no. of your device. This information can be found on the back near the inlet for the power supply cable.

To identify the software version, proceed as follows:

1. Hold down any of the keys and then switch on the centrifuge.
You enter the system menu.
2. Press the START key .
3. Press and hold the ENTER key , until the following message is displayed:

Software ID: XXXXXXXX

4. Communicate the software version to the service technician.

Chemical Compatibility Chart

CHEMICAL	ALUMINUM	ANODIC COATING for ALUMINIUM	BUNA N	CELLULOSE ACETATE BUTYRATE	POLYURETHANE ROTOR PAINT	COMPOSITE Carbon Fiber/Epoxy	DELRIN®	ETHYLENE PROPYLENE	GLASS	NEOPRENE	NORYL®	NYLON	PET®, POLYCLEAR®, CLEARCRIMP®, CCCLEARCRIMP®	POLYALLOMER	POLYCARBONATE	POLYESTER, GLASS THERMOSET	POLYETHERIMIDE	POLYETHYLENE	POLYPROPYLENE	POLYSULFONE	POLYVINYL CHLORIDE	RULON A®, TEFLON®	SILICONE RUBBER	STAINLESS STEEL	TITANIUM	TYGON®	VITON®	
2-mercaptoethanol	S	S	U	-	S	M	S	-	S	U	S	S	U	S	S	-	S	S	S	S	U	S	S	S	S	S	S	
Acetaldehyde	S	-	U	U	-	-	-	M	-	U	-	-	-	M	U	U	U	M	M	-	M	S	U	-	S	-	U	
Acetone	M	S	U	U	S	U	M	S	S	U	U	S	U	S	U	U	U	S	S	U	U	S	M	M	S	U	U	
Acetonitrile	S	S	U	-	S	M	S	-	S	S	U	S	U	M	U	U	-	S	M	U	U	S	S	S	S	U	U	
Alconox®	U	U	S	-	S	S	S	-	S	S	S	S	S	S	M	S	S	S	S	S	S	S	S	S	S	S	U	
Allyl Alcohol	-	-	-	U	-	-	S	-	-	-	-	S	-	S	S	M	S	S	S	S	-	M	S	-	-	S	-	
Aluminum Chloride	U	U	S	S	S	S	U	S	S	S	S	M	S	S	S	S	-	S	S	S	S	S	M	U	U	S	S	
Formic Acid (100%)	-	S	M	U	-	-	U	-	-	-	-	U	-	S	M	U	U	S	S	-	U	S	-	U	S	-	U	
Ammonium Acetate	S	S	U	-	S	S	S	-	S	S	S	S	S	S	S	U	-	S	S	S	S	S	S	S	S	S	S	
Ammonium Carbonate	M	S	U	S	S	S	S	S	S	S	S	S	S	S	U	U	-	S	S	S	S	S	S	M	S	S	S	
Ammonium Hydroxide (10%)	U	U	S	U	S	S	M	S	S	S	S	S	-	S	U	M	S	S	S	S	S	S	S	S	S	M	S	
Ammonium Hydroxide (28%)	U	U	S	U	S	U	M	S	S	S	S	S	U	S	U	M	S	S	S	S	S	S	S	S	S	M	S	
Ammonium Hydroxide (conc.)	U	U	U	U	S	U	M	S	-	S	-	S	U	S	U	U	S	S	S	-	M	S	S	S	S	-	U	
Ammonium Phosphate	U	-	S	-	S	S	S	S	S	S	S	S	-	S	S	M	-	S	S	S	S	S	S	M	S	S	S	
Ammonium Sulfate	U	M	S	-	S	S	U	S	S	S	S	S	S	S	S	S	-	S	S	S	S	S	S	U	S	S	U	
Amyl Alcohol	S	-	M	U	-	-	S	S	-	M	-	S	-	M	S	S	S	S	M	-	-	-	U	-	S	-	M	
Aniline	S	S	U	U	S	U	S	M	S	U	U	U	U	U	U	U	-	S	M	U	U	S	S	S	S	U	S	
Sodium Hydroxide (<1%)	U	-	M	S	S	S	-	-	S	M	S	S	-	S	M	M	S	S	S	S	S	S	M	S	S	-	U	
Sodium Hydroxide (10%)	U	-	M	U	-	-	U	-	M	M	S	S	U	S	U	U	S	S	S	S	S	S	M	S	S	-	U	
Barium Salts	M	U	S	-	S	S	S	S	S	S	S	S	S	S	S	M	-	S	S	S	S	S	M	S	S	S	S	
Benzene	S	S	U	U	S	U	M	U	S	U	U	S	U	U	U	M	U	M	U	U	U	S	U	U	S	U	S	
Benzyl Alcohol	S	-	U	U	-	-	M	M	-	M	-	S	U	U	U	U	U	U	U	U	-	M	S	M	-	S	-	S

A Chemical Compatibility Chart

CHEMICAL	MATERIAL																											
	ALUMINUM	ANODIC COATING for ALUMINIUM	BUNA N	CELLULOSE ACETATE BUTYRATE	POLYURETHANE ROTOR PAINT	COMPOSITE Carbon Fiber/Epoxy	DELRIN®	ETHYLENE PROPYLENE	GLASS	NEOPRENE	NORYL®	NYLON	PET®, POLYCLEAR®, CLEARCRIMP®, CCCLEARCRIMP®	POLYALLUMER	POLYCARBONATE	POLYESTER, GLASS THERMOSET	POLYETHERIMIDE	POLYETHYLENE	POLYPROPYLENE	POLYSULFONE	POLYVINYL CHLORIDE	RULON A®, TEFLON®	SILICONE RUBBER	STAINLESS STEEL	TITANIUM	TYGON®	VITON®	
Boric Acid	U	S	S	M	S	S	U	S	S	S	S	S	S	S	S	S	U	S	S	S	S	S	S	S	S	S	S	S
Cesium Acetate	M	-	S	-	S	S	S	-	S	S	S	S	-	S	S	-	-	S	S	S	S	S	S	S	M	S	S	S
Cesium Bromide	M	S	S	-	S	S	S	-	S	S	S	S	S	S	S	-	-	S	S	S	S	S	S	M	S	S	S	S
Cesium Chloride	M	S	S	U	S	S	S	-	S	S	S	S	S	S	S	-	-	S	S	S	S	S	S	M	S	S	S	S
Cesium Formate	M	S	S	-	S	S	S	-	S	S	S	S	S	S	S	-	-	S	S	S	S	S	S	M	S	S	S	S
Cesium Iodide	M	S	S	-	S	S	S	-	S	S	S	S	S	S	S	-	-	S	S	S	S	S	S	M	S	S	S	S
Cesium Sulfate	M	S	S	-	S	S	S	-	S	S	S	S	S	S	S	-	-	S	S	S	S	S	S	M	S	S	S	S
Chloroform	U	U	U	U	S	S	M	U	S	U	U	M	U	M	U	U	U	M	M	U	U	S	U	U	U	M	S	
Chromic Acid (10%)	U	-	U	U	S	U	U	-	S	S	S	U	S	S	M	U	M	S	S	U	M	S	M	U	S	S	S	
Chromic Acid (50%)	U	-	U	U	-	U	U	-	-	-	S	U	U	S	M	U	M	S	S	U	M	S	-	U	M	-	S	
Cresol Mixture	S	S	U	-	-	-	S	-	S	U	U	U	U	U	U	-	-	U	U	-	U	S	S	S	S	U	S	
Cyclohexane	S	S	S	-	S	S	S	U	S	U	S	S	U	U	U	M	S	M	U	M	M	S	U	M	M	U	S	
Deoxycholate	S	S	S	-	S	S	S	-	S	S	S	S	S	S	S	-	-	S	S	S	S	S	S	S	S	S	S	
Distilled Water	S	S	S	S	S	S	S	S	S	S	S	S	S	S	S	S	S	S	S	S	S	S	S	S	S	S	S	
Dextran	M	S	S	S	S	S	S	-	S	S	S	S	S	S	S	S	S	S	S	S	S	S	S	M	S	S	S	
Diethyl Ether	S	S	U	U	S	S	S	U	S	U	U	S	U	U	U	U	U	U	U	U	U	S	S	S	S	M	U	
Diethyl Ketone	S	-	U	U	-	-	M	-	S	U	-	S	-	M	U	U	U	M	M	-	U	S	-	-	S	U	U	
Diethylpyrocarbonate	S	S	U	-	S	S	S	-	S	S	U	S	U	S	U	-	-	S	S	S	M	S	S	S	S	S	S	
Dimethylsulfoxide	S	S	U	U	S	S	S	-	S	U	S	S	U	S	U	U	-	S	S	U	U	S	S	S	S	U	U	
Dioxane	M	S	U	U	S	S	M	M	S	U	U	S	U	M	U	U	-	M	M	M	U	S	S	S	S	U	U	
Ferric Chloride	U	U	S	-	-	-	M	S	-	M	-	S	-	S	-	-	-	S	S	-	-	-	M	U	S	-	S	
Acetic Acid (Glacial)	S	S	U	U	S	S	U	M	S	U	S	U	U	U	U	U	M	S	U	M	U	S	U	U	S	-	U	
Acetic Acid (5%)	S	S	M	S	S	S	M	S	S	S	S	S	M	S	S	S	S	S	S	S	M	S	S	M	S	S	M	
Acetic Acid (60%)	S	S	U	U	S	S	U	-	S	M	S	U	U	M	U	S	M	S	M	S	M	S	M	U	S	M	U	
Ethyl Acetate	M	M	U	U	S	S	M	M	S	S	U	S	U	M	U	U	-	S	S	U	U	S	M	M	S	U	U	
Ethyl Alcohol (50%)	S	S	S	S	S	S	M	S	S	S	S	S	U	S	U	S	S	S	S	S	S	S	S	M	S	M	U	
Ethyl Alcohol (95%)	S	S	S	U	S	S	M	S	S	S	S	S	U	S	U	-	S	S	S	M	S	S	S	U	S	M	U	
Ethylene Dichloride	S	-	U	U	-	-	S	M	-	U	U	S	U	U	U	U	U	U	U	-	U	S	U	-	S	-	S	
Ethylene Glycol	S	S	S	S	S	S	S	S	S	S	S	S	-	S	U	S	S	S	S	S	S	S	M	S	M	S	S	

CHEMICAL	MATERIAL																										
	ALUMINIUM	ANODIC COATING for ALUMINIUM	BUNA N	CELLULOSE ACETATE BUTYRATE	POLYURETHANE ROTOR PAINT	COMPOSITE Carbon Fiber/Epoxy	DELIRIN®	ETHYLENE PROPYLENE	GLASS	NEOPRENE	NORYL®	NYLON	PET®, POLYCLEAR®, CLEARCRIMP®, CCCLEARCRIMP®	POLYALLUMER	POLYCARBONATE	POLYESTER, GLASS THERMOSET	POLYTHERMIDE	POLYRTHYLENE	POLYPROPYLENE	POLYSULFONE	POLYVINYL CHLORIDE	RULON A®, TEFLON®	SILICONE RUBBER	STAINLESS STEEL	TITANIUM	TYGON®	VITON®
Ethylene Oxide Vapor	S	-	U	-	-	U	-	-	S	U	-	S	-	S	M	-	-	S	S	S	U	S	U	S	S	S	U
Ficoll-Hypaque®	M	S	S	-	S	S	S	-	S	S	S	S	-	S	S	-	S	S	S	S	S	S	S	M	S	S	S
Hydrofluoric Acid (10%)	U	U	U	M	-	-	U	-	-	U	U	S	-	S	M	U	S	S	S	S	M	S	U	U	U	-	-
Hydrofluoric Acid (50%)	U	U	U	U	-	-	U	-	-	U	U	U	U	S	U	U	U	S	S	M	M	S	U	U	U	-	M
Hydrochloric Acid (conc.)	U	U	U	U	-	U	U	M	-	U	M	U	U	M	U	U	U	-	S	-	U	S	U	U	U	-	-
Formaldehyde (40%)	M	M	M	S	S	S	S	M	S	S	S	S	M	S	S	S	U	S	S	M	S	S	S	M	S	M	U
Glutaraldehyde	S	S	S	S	-	-	S	-	S	S	S	S	S	S	S	-	-	S	S	S	-	-	S	S	S	-	-
Glycerol	M	S	S	-	S	S	S	S	S	S	S	S	S	S	S	S	-	S	S	S	S	S	S	S	S	S	S
Guanidine Hydrochloride	U	U	S	-	S	S	S	-	S	S	S	S	S	S	S	-	-	S	S	S	S	S	S	U	S	S	S
Haemo-Sol®	S	S	S	-	-	-	S	-	S	S	S	S	S	S	S	-	-	S	S	S	S	S	S	S	S	S	S
Hexane	S	S	S	-	S	S	S	-	S	S	U	S	U	M	U	S	S	U	S	S	M	S	U	S	S	U	S
Isobutyl Alcohol	-	-	M	U	-	-	S	S	-	U	-	S	U	S	S	M	S	S	S	-	S	S	S	-	S	-	S
Isopropyl Alcohol	M	M	M	U	S	S	S	S	S	U	S	S	U	S	U	M	S	S	S	S	S	S	S	M	M	M	S
Iodoacetic Acid	S	S	M	-	S	S	S	-	S	M	S	S	M	S	S	-	M	S	S	S	S	S	M	S	S	M	M
Potassium Bromide	U	S	S	-	S	S	S	-	S	S	S	S	S	S	S	S	S	S	S	-	S	S	S	M	S	S	S
Potassium Carbonate	M	U	S	S	S	S	S	-	S	S	S	S	S	U	S	S	S	S	S	S	S	S	S	S	S	S	S
Potassium Chloride	U	S	S	-	S	S	S	S	S	S	S	S	S	S	S	-	S	S	S	S	S	S	S	U	S	S	S
Potassium Hydroxide (5%)	U	U	S	S	S	S	M	-	S	S	S	S	-	S	U	S	S	S	S	S	S	S	M	U	M	S	U
Potassium Hydroxide (conc.)	U	U	M	U	-	-	M	-	M	S	S	-	U	M	U	U	U	S	M	-	M	U	-	U	U	-	U
Potassium Permanganate	S	S	S	-	S	S	S	-	S	S	S	U	S	S	S	M	-	S	M	S	U	S	S	M	S	U	S
Calcium Chloride	M	U	S	S	S	S	S	S	S	S	S	S	S	S	M	S	-	S	S	S	S	S	S	M	S	S	S
Calcium Hypochlorite	M	-	U	-	S	M	M	S	-	M	-	S	-	S	M	S	-	S	S	S	M	S	M	U	S	-	S
Kerosene	S	S	S	-	S	S	S	U	S	M	U	S	U	M	M	S	-	M	M	M	S	S	U	S	S	U	S
Sodium Chloride (10%)	S	-	S	S	S	S	S	S	-	-	-	S	S	S	S	S	-	S	S	S	S	-	S	S	M	-	S
Sodium Chloride (sat'd)	U	-	S	U	S	S	S	-	-	-	-	S	S	S	S	S	-	S	S	-	S	-	S	S	M	-	S
Carbon Tetrachloride	U	U	M	S	S	U	M	U	S	U	U	S	U	M	U	S	S	M	M	S	M	M	M	M	U	S	S
Aqua Regia	U	-	U	U	-	-	U	-	-	-	-	-	U	U	U	U	U	U	U	-	-	-	-	-	S	-	M
Solution 555 (20%)	S	S	S	-	-	-	S	-	S	S	S	S	S	S	S	-	-	S	S	S	-	S	S	S	S	S	S
Magnesium Chloride	M	S	S	-	S	S	S	S	S	S	S	S	S	S	S	S	S	S	S	S	S	S	S	M	S	S	S

A Chemical Compatibility Chart

CHEMICAL	ALUMINUM	ANODIC COATING for ALUMINIUM	BUNA N	CELLULOSE ACETATE BUTYRATE	POLYURETHANE ROTOR PAINT	COMPOSITE Carbon Fiber/Epoxy	DELTRIN®	ETHYLENE PROPYLENE	GLASS	NEOPRENE	NORYL®	NYLON	PET®, POLYCLEAR®, CLEARCRIMP®, CCCLEARCRIMP®	POLYALLUMER	POLYCARBONATE	POLYESTER, GLASS THERMOSET	POLYETHERIMIDE	POLYETHYLENE	POLYPROPYLENE	POLYSULFONE	POLYVINYL CHLORIDE	RULON A®, TEFLON®	SILICONE RUBBER	STAINLESS STEEL	TITANIUM	TYGON®	VITON®
Mercaptoacetic Acid	U	S	U	-	S	M	S	-	S	M	S	U	U	U	U	-	S	U	U	S	M	S	U	S	S	S	S
Methyl Alcohol	S	S	S	U	S	S	M	S	S	S	S	S	U	S	U	M	S	S	S	S	S	S	S	M	S	M	U
Methylene Chloride	U	U	U	U	M	S	S	U	S	U	U	S	U	U	U	U	U	M	U	U	U	S	S	M	U	S	U
Methyl Ethyl Ketone	S	S	U	U	S	S	M	S	S	U	U	S	U	S	U	U	U	S	S	U	U	S	S	S	S	U	U
Metrizamide®	M	S	S	-	S	S	S	-	S	S	S	S	-	S	S	-	-	S	S	S	S	S	S	M	S	S	S
Lactic Acid (100%)	-	-	S	-	-	-	-	-	-	M	S	U	-	S	S	S	M	S	S	-	M	S	M	S	S	-	S
Lactic Acid (20%)	-	-	S	S	-	-	-	-	-	M	S	M	-	S	S	S	S	S	S	S	M	S	M	S	S	-	S
N-Butyl Alcohol	S	-	S	U	-	-	S	-	-	S	M	-	U	S	M	S	S	S	S	M	M	S	M	-	S	-	S
N-Butyl Phthalate	S	S	U	-	S	S	S	-	S	U	U	S	U	U	U	M	-	U	U	S	U	S	M	M	S	U	S
N, N-Dimethylformamide	S	S	S	U	S	M	S	-	S	S	U	S	U	S	U	U	-	S	S	U	U	S	M	S	S	S	U
Sodium Borate	M	S	S	S	S	S	S	S	S	S	S	U	S	S	S	S	-	S	S	S	S	S	S	M	S	S	S
Sodium Bromide	U	S	S	-	S	S	S	-	S	S	S	S	S	S	S	S	-	S	S	S	S	S	S	M	S	S	S
Sodium Carbonate (2%)	M	U	S	S	S	S	S	S	S	S	S	S	S	S	U	S	S	S	S	S	S	S	S	S	S	S	S
Sodium Dodecyl Sulfate	S	S	S	-	S	S	S	-	S	S	S	S	S	S	S	-	S	S	S	S	S	S	S	S	S	S	S
Sodium Hypochlorite (5%)	U	U	M	S	S	M	U	S	S	M	S	S	S	M	S	S	S	S	M	S	S	S	M	U	S	M	S
Sodium Iodide	M	S	S	-	S	S	S	-	S	S	S	S	S	S	S	-	-	S	S	S	S	S	S	M	S	S	S
Sodium Nitrate	S	S	S	-	S	S	S	S	S	S	S	S	S	S	S	S	-	S	S	S	S	S	S	U	S	S	S
Sodium Sulfate	U	S	S	-	S	S	S	S	S	S	S	S	S	S	S	S	S	S	S	S	S	S	S	M	S	S	S
Sodium Sulfide	S	-	S	S	-	-	-	S	-	-	-	S	S	S	U	U	-	-	S	-	-	-	S	S	M	-	S
Sodium Sulfite	S	S	S	-	S	S	S	S	M	S	S	S	S	S	S	M	-	S	S	S	S	S	S	S	S	S	S
Nickel Salts	U	S	S	S	S	S	-	S	S	S	-	-	S	S	S	S	-	S	S	S	S	S	S	M	S	S	S
Oils (Petroleum)	S	S	S	-	-	-	S	U	S	S	S	S	U	U	M	S	M	U	U	S	S	S	U	S	S	S	S
Oils (Other)	S	-	S	-	-	-	S	M	S	S	S	S	U	S	S	S	S	U	S	S	S	S	-	S	S	M	S
Oleic Acid	S	-	U	S	S	S	U	U	S	U	S	S	M	S	S	S	S	S	S	S	S	S	M	U	S	M	M
Oxalic Acid	U	U	M	S	S	S	U	S	S	S	S	U	S	U	S	S	S	S	S	S	S	S	S	U	M	S	S
Perchloric Acid (10%)	U	-	U	-	S	U	U	-	S	M	M	-	-	M	U	M	S	M	M	-	M	S	U	-	S	-	S
Perchloric Acid (70%)	U	U	U	-	-	U	U	-	S	U	M	U	U	M	U	U	M	M	U	M	S	U	U	S	U	S	S
Phenol (5%)	U	S	U	-	S	M	M	-	S	U	M	U	U	S	U	M	S	M	S	U	U	S	U	M	M	M	S
Phenol (50%)	U	S	U	-	S	U	M	-	S	U	M	U	U	U	U	U	S	U	M	U	U	S	U	U	U	M	S

CHEMICAL	MATERIAL																											
	ALUMINUM	ANODIC COATING for ALUMINIUM	BUNA N	CELLULOSE ACETATE BUTYRATE	POLYURETHANE ROTOR PAINT	COMPOSITE Carbon Fiber/Epoxy	DELRIN®	ETHYLENE PROPYLENE	GLASS	NEOPRENE	NORYL®	NYLON	PET®, POLYCLEAR®, CLEARCRIMP®, CCCLEARCRIMP®	POLYALLUMER	POLYCARBONATE	POLYESTER, GLASS THERMOSET	POLYTHERMIDE	POLYRTHYLENE	POLYPROPYLENE	POLYSULFONE	POLYVINYL CHLORIDE	RULON A®, TEFLON®	SILICONE RUBBER	STAINLESS STEEL	TITANIUM	TYGON®	VITON®	
Phosphoric Acid (10%)	U	U	M	S	S	S	U	S	S	S	S	U	-	S	S	S	S	S	S	S	S	S	U	M	U	S	S	
Phosphoric Acid (conc.)	U	U	M	M	-	-	U	S	-	M	S	U	U	M	M	S	S	S	M	S	M	S	U	M	U	-	S	
Physiologic Media (Serum, Urine)	M	S	S	S	-	-	S	-	S	S	S	S	S	S	S	S	S	S	S	S	S	S	S	S	S	S	S	
Picric Acid	S	S	U	-	S	M	S	S	S	M	S	U	S	S	S	U	S	S	S	S	U	S	U	M	S	M	S	
Pyridine (50%)	U	S	U	U	S	U	U	-	U	S	S	U	U	M	U	U	-	U	S	M	U	S	S	U	U	U	U	
Rubidium Bromide	M	S	S	-	S	S	S	-	S	S	S	S	S	S	S	-	-	S	S	S	S	S	S	M	S	S	S	
Rubidium Chloride	M	S	S	-	S	S	S	-	S	S	S	S	S	S	S	-	-	S	S	S	S	S	M	S	S	S	S	
Sucrose	M	S	S	-	S	S	S	S	S	S	S	S	S	S	S	S	S	S	S	S	S	S	S	S	S	S	S	
Sucrose, Alkaline	M	S	S	-	S	S	S	-	S	S	S	S	S	S	U	S	S	S	S	S	S	S	M	S	S	S	S	
Sulfosalicylic Acid	U	U	S	S	S	S	S	-	S	S	S	U	S	S	S	-	S	S	S	-	S	S	U	S	S	S	S	
Nitric Acid (10%)	U	S	U	S	S	U	U	-	S	U	S	U	-	S	S	S	S	S	S	S	S	M	S	S	S	S	S	
Nitric Acid (50%)	U	S	U	M	S	U	U	-	S	U	S	U	U	M	M	U	M	M	M	S	S	S	U	S	S	M	S	
Nitric Acid (95%)	U	-	U	U	-	U	U	-	-	U	U	U	U	M	U	U	U	U	M	U	U	S	U	S	S	-	S	
Hydrochloric Acid (10%)	U	U	M	S	S	S	U	-	S	S	S	U	U	S	U	S	S	S	S	S	S	S	U	M	S	S	S	
Hydrochloric Acid (50%)	U	U	U	U	S	U	U	-	S	M	S	U	U	M	U	U	S	S	S	S	M	S	M	U	U	M	M	
Sulfuric Acid (10%)	M	U	U	S	S	U	U	-	S	S	M	U	S	S	S	S	S	S	S	S	S	S	U	U	U	S	S	
Sulfuric Acid (50%)	M	U	U	U	S	U	U	-	S	S	M	U	U	S	U	U	M	S	S	S	S	S	U	U	U	M	S	
Sulfuric Acid (conc.)	M	U	U	U	-	U	U	M	-	-	M	U	U	S	U	U	U	M	S	U	M	S	U	U	U	-	S	
Stearic Acid	S	-	S	-	-	-	S	M	S	S	S	S	-	S	S	S	S	S	S	S	S	M	M	S	S	S	S	
Tetrahydrofuran	S	S	U	U	S	U	U	M	S	U	U	S	U	U	U	-	M	U	U	U	U	S	U	S	S	U	U	
Toluene	S	S	U	U	S	S	M	U	S	U	U	S	U	U	U	S	U	M	U	U	U	S	U	S	U	U	M	
Trichloroacetic Acid	U	U	U	-	S	S	U	M	S	U	S	U	U	S	M	-	M	S	S	U	U	S	U	U	U	M	U	
Trichloroethane	S	-	U	-	-	-	M	U	-	U	-	S	U	U	U	U	U	U	U	U	U	S	U	-	S	-	S	
Trichloroethylene	-	-	U	U	-	-	-	U	-	U	-	S	U	U	U	U	U	U	U	U	U	S	U	-	U	-	S	
Trisodium Phosphate	-	-	-	S	-	-	M	-	-	-	-	-	-	S	-	-	S	S	S	-	-	S	-	-	S	-	S	
Tris Buffer (neutral pH)	U	S	S	S	S	S	S	-	S	S	S	S	S	S	S	S	S	S	S	S	S	S	S	S	S	S	S	
Triton X-100®	S	S	S	-	S	S	S	-	S	S	S	S	S	S	S	S	S	S	S	S	S	S	S	S	S	S	S	
Urea	S	-	U	S	S	S	S	-	-	-	-	S	S	S	M	S	S	S	S	-	S	S	S	M	S	-	S	
Hydrogen Peroxide (10%)	U	U	M	S	S	U	U	-	S	S	S	U	S	S	S	M	U	S	S	S	S	S	M	S	U	S	S	

A Chemical Compatibility Chart

CHEMICAL	MATERIAL	ALUMINIUM	ANODIC COATING for ALUMINIUM	BUNA N	CELLULOSE ACETATE BUTYRATE	POLYURETHANE ROTOR PAINT	COMPOSITE Carbon Fiber/Epoxy	DELRIN®	ETHYLENE PROPYLENE	GLASS	NEOPRENE	NORYL®	NYLON	PET*, POLYCLEAR®, CLEARCRIMP®, CCLLEARCRIMP®	POLYALLUMER	POLYCARBONATE	POLYESTER, GLASS THERMOSET	POLYETHERIMIDE	POLYETHYLENE	POLYPROPYLENE	POLYSULFONE	POLYVINYL CHLORIDE	RULON A®, TEFLON®	SILICONE RUBBER	STAINLESS STEEL	TITANIUM	TYGON®	VITON®
Hydrogen Peroxide (3%)		S	M	S	S	S	-	S	-	S	S	S	S	S	S	S	S	M	S	S	S	S	S	S	S	S	S	S
Xylene		S	S	U	S	S	S	M	U	S	U	U	U	U	U	U	M	U	M	U	U	U	S	U	M	S	U	S
Zinc Chloride		U	U	S	S	S	S	U	S	S	S	S	S	S	S	S	S	S	S	S	S	S	S	S	S	U	S	S
Zinc Sulfate		U	S	S	-	S	S	S	S	S	S	S	S	S	S	S	S	S	S	S	S	S	S	S	S	S	S	S
Citric Acid (10%)		M	S	S	M	S	S	M	S	S	S	S	S	S	S	S	S	M	S	S	S	S	S	S	S	S	S	S

*Polyethyleneterephthalate

Key

S Satisfactory

M M = Moderate attack, may be satisfactory for use in centrifuge depending on length of exposure, speed involved, etc.; suggest testing under actual conditions of use.

U U = Unsatisfactory, not recommended.

-- No data available. Because no organized chemical resistance data exists for materials under the stress of centrifugation, when in doubt we recommend pretesting sample lots. suggest testing, using sample to avoid loss of valuable material.

Chemical resistance data is included only as a guide to product use.

Contact Information

United States	866-9-THERMO
	+1 866 984 3766

Canada	+1 866 984 3766
--------	-----------------

Austria	+43 1 801 400
---------	---------------

Belgium	+32 2 482 30 30
---------	-----------------

Germany	08001 536 376
	+49 6184 90 6940

France	+33 2 2803 2180
	+33 2 2803 2000

Italy	+39 02 02 95059 341
-------	---------------------

Netherlands	+31 76 571 4440
-------------	-----------------

Nordic / Baltic Countries	+35 89 329 100
---------------------------	----------------

Russia	+7 (812) 703 42 15
--------	--------------------

B Contact Information

Spain +34 932 23 09 18

Portugal +34 932 23 09 18

Switzerland +41 44 454 12 12

UK / Ireland +44 870 609 9203

China +86 21 6865 4588

+86 10 8419 3588

India +91 22 6716 2200

Japan +81 45 453 9220

Other Asian Countries +852 2885 4613

Latin America +1 866 984 3766

Other Countries +49 6184 90 6940

+33 2 2803 2180

Index

- A**
- Acceleration Curve 4-4
 - Accident Prevention iv
 - Aerosol-proof Rotors 4-9
 - Aligning the Centrifuge 2-3
 - Autoclaving 6-5
- B**
- Braking Profile 4-4
 - Bucket Selection 4-6
- C**
- Care 6-1
 - Centrifugation 4-7
 - Cleaning 6-2
 - Cleaning Agents 6-3
 - Close Lid 4-2
 - Contact Information C-1
 - Continuous Operation 4-5
 - Control Panel 3-2
- D**
- Decontamination 6-4
 - Disinfection 6-3
- E**
- Emergency Lid Release 7-2
 - Entering Parameters 4-4
 - Explanation of RCF Value 4-5
- F**
- Failure Message 7-3
 - Failures 7-1
 - Features 1-5
- I**
- Imbalance Indicator 4-7
 - Installation Location 2-2
- K**
- Keys 3-3
- L**
- Lid Opening 4-2
- M**
- Mains Connection 2-3
 - Mains Supply 2-4
 - Maintenance 6-1
- O**
- Operation 4-1
- P**
- Precautions iv
 - Preface iii
 - Preselecting Speed 4-4
 - Preselecting the Temperature 4-5
 - Prewarming or Precooling 4-6
 - Prewarming or Precooling the Centrifuge 4-6
 - Proper Use v
- R**
- Rating Plate 2-4
 - Removing the Rotor 4-8
 - Rotor Installation 4-2
 - Rotor Selection 1-6
 - Running Time Preselection 4-5
- S**
- Safety Area 2-2
 - Safety Features 1-2
 - Service Technician 6-6, 7-6
 - Short-term Centrifugation 4-8

Index:

Starting Centrifuge Program 4-7
Stopping the Centrifuging Program 4-7
Storage 2-4
Switch on Centrifuge 4-2

T

Technical Data 1-3
Temperature Adaptation 4-8
Transporting the Centrifuge 2-2

